



**ROHDE & SCHWARZ**

Test and Measurement  
Division

## Operating Manual

# VECTOR SIGNAL GENERATOR

## **SMIQ02B**

1125.5555.02

## **SMIQ03B**

1125.5555.03

## **SMIQ03HD**

1125.5555.33

## **SMIQ04B**

1125.5555.04

## **SMIQ06B**

1125.5555.06

## **SMIQ06ATE**

1125.5555.26

**Volume 2**

*This Operating Manual consists of 2 volumes*

Printed in the Federal  
Republic of Germany



# Basic Safety Instructions

## Always read through and comply with the following safety instructions!

All plants and locations of the Rohde & Schwarz group of companies make every effort to keep the safety standards of our products up to date and to offer our customers the highest possible degree of safety. Our products and the auxiliary equipment they require are designed, built and tested in accordance with the safety standards that apply in each case. Compliance with these standards is continuously monitored by our quality assurance system. The product described here has been designed, built and tested in accordance with the EC Certificate of Conformity and has left the manufacturer's plant in a condition fully complying with safety standards. To maintain this condition and to ensure safe operation, you must observe all instructions and warnings provided in this manual. If you have any questions regarding these safety instructions, the Rohde & Schwarz group of companies will be happy to answer them.

Furthermore, it is your responsibility to use the product in an appropriate manner. This product is designed for use solely in industrial and laboratory environments or, if expressly permitted, also in the field and must not be used in any way that may cause personal injury or property damage. You are responsible if the product is used for any purpose other than its designated purpose or in disregard of the manufacturer's instructions. The manufacturer shall assume no responsibility for such use of the product.

The product is used for its designated purpose if it is used in accordance with its product documentation and within its performance limits (see data sheet, documentation, the following safety instructions). Using the product requires technical skills and, in some cases, a basic knowledge of English. It is therefore essential that only skilled and specialized staff or thoroughly trained personnel with the required skills be allowed to use the product. If personal safety gear is required for using Rohde & Schwarz products, this will be indicated at the appropriate place in the product documentation. Keep the basic safety instructions and the product documentation in a safe place and pass them on to the subsequent users.

Observing the safety instructions will help prevent personal injury or damage of any kind caused by dangerous situations. Therefore, carefully read through and adhere to the following safety instructions before and when using the product. It is also absolutely essential to observe the additional safety instructions on personal safety, for example, that appear in relevant parts of the product documentation. In these safety instructions, the word "product" refers to all merchandise sold and distributed by the Rohde & Schwarz group of companies, including instruments, systems and all accessories. For product-specific information, see the data sheet and the product documentation.

## Safety labels on products

The following safety labels are used on products to warn against risks and dangers.

Symbol	Meaning	Symbol	Meaning
	Notice, general danger location Observe product documentation		ON/OFF Power
	Caution when handling heavy equipment		Standby indication
	Danger of electric shock		Direct current (DC)

## Basic Safety Instructions

Symbol	Meaning	Symbol	Meaning
	Caution ! Hot surface		Alternating current (AC)
	Protective conductor terminal To identify any terminal which is intended for connection to an external conductor for protection against electric shock in case of a fault, or the terminal of a protective earth		Direct/alternating current (DC/AC)
	Earth (Ground)		Class II Equipment to identify equipment meeting the safety requirements specified for Class II equipment (device protected by double or reinforced insulation)
	Frame or chassis Ground terminal		EU labeling for batteries and accumulators For additional information, see section "Waste disposal/Environmental protection", item 1.
	Be careful when handling electrostatic sensitive devices		EU labeling for separate collection of electrical and electronic devices For additional information, see section "Waste disposal/Environmental protection", item 2.
	Warning! Laser radiation For additional information, see section "Operation", item 7.		

### Signal words and their meaning

The following signal words are used in the product documentation in order to warn the reader about risks and dangers.



Indicates a hazardous situation which, if not avoided, will result in death or serious injury.



Indicates a hazardous situation which, if not avoided, could result in death or serious injury.



Indicates a hazardous situation which, if not avoided, could result in minor or moderate injury.



Indicates information considered important, but not hazard-related, e.g. messages relating to property damage.

In the product documentation, the word ATTENTION is used synonymously.

These signal words are in accordance with the standard definition for civil applications in the European Economic Area. Definitions that deviate from the standard definition may also exist in other economic areas or military applications. It is therefore essential to make sure that the signal words described here are always used only in connection with the related product documentation and the related product. The use of signal words in connection with unrelated products or documentation can result in misinterpretation and in personal injury or material damage.

## Basic Safety Instructions

### Operating states and operating positions

*The product may be operated only under the operating conditions and in the positions specified by the manufacturer, without the product's ventilation being obstructed. If the manufacturer's specifications are not observed, this can result in electric shock, fire and/or serious personal injury or death. Applicable local or national safety regulations and rules for the prevention of accidents must be observed in all work performed.*

1. Unless otherwise specified, the following requirements apply to Rohde & Schwarz products: predefined operating position is always with the housing floor facing down, IP protection 2X, use only indoors, max. operating altitude 2000 m above sea level, max. transport altitude 4500 m above sea level. A tolerance of  $\pm 10\%$  shall apply to the nominal voltage and  $\pm 5\%$  to the nominal frequency, overvoltage category 2, pollution degree 2.
2. Do not place the product on surfaces, vehicles, cabinets or tables that for reasons of weight or stability are unsuitable for this purpose. Always follow the manufacturer's installation instructions when installing the product and fastening it to objects or structures (e.g. walls and shelves). An installation that is not carried out as described in the product documentation could result in personal injury or even death.
3. Do not place the product on heat-generating devices such as radiators or fan heaters. The ambient temperature must not exceed the maximum temperature specified in the product documentation or in the data sheet. Product overheating can cause electric shock, fire and/or serious personal injury or even death.

### Electrical safety

*If the information on electrical safety is not observed either at all or to the extent necessary, electric shock, fire and/or serious personal injury or death may occur.*

1. Prior to switching on the product, always ensure that the nominal voltage setting on the product matches the nominal voltage of the mains-supply network. If a different voltage is to be set, the power fuse of the product may have to be changed accordingly.
2. In the case of products of safety class I with movable power cord and connector, operation is permitted only on sockets with a protective conductor contact and protective conductor.
3. Intentionally breaking the protective conductor either in the feed line or in the product itself is not permitted. Doing so can result in the danger of an electric shock from the product. If extension cords or connector strips are implemented, they must be checked on a regular basis to ensure that they are safe to use.
4. If there is no power switch for disconnecting the product from the mains, or if the power switch is not suitable for this purpose, use the plug of the connecting cable to disconnect the product from the mains. In such cases, always ensure that the power plug is easily reachable and accessible at all times. For example, if the power plug is the disconnecting device, the length of the connecting cable must not exceed 3 m. Functional or electronic switches are not suitable for providing disconnection from the AC supply network. If products without power switches are integrated into racks or systems, the disconnecting device must be provided at the system level.
5. Never use the product if the power cable is damaged. Check the power cables on a regular basis to ensure that they are in proper operating condition. By taking appropriate safety measures and carefully laying the power cable, ensure that the cable cannot be damaged and that no one can be hurt by, for example, tripping over the cable or suffering an electric shock.

## Basic Safety Instructions

6. The product may be operated only from TN/TT supply networks fuse-protected with max. 16 A (higher fuse only after consulting with the Rohde & Schwarz group of companies).
7. Do not insert the plug into sockets that are dusty or dirty. Insert the plug firmly and all the way into the socket provided for this purpose. Otherwise, sparks that result in fire and/or injuries may occur.
8. Do not overload any sockets, extension cords or connector strips; doing so can cause fire or electric shocks.
9. For measurements in circuits with voltages  $V_{rms} > 30$  V, suitable measures (e.g. appropriate measuring equipment, fuse protection, current limiting, electrical separation, insulation) should be taken to avoid any hazards.
10. Ensure that the connections with information technology equipment, e.g. PCs or other industrial computers, comply with the IEC 60950-1 / EN 60950-1 or IEC 61010-1 / EN 61010-1 standards that apply in each case.
11. Unless expressly permitted, never remove the cover or any part of the housing while the product is in operation. Doing so will expose circuits and components and can lead to injuries, fire or damage to the product.
12. If a product is to be permanently installed, the connection between the protective conductor terminal on site and the product's protective conductor must be made first before any other connection is made. The product may be installed and connected only by a licensed electrician.
13. For permanently installed equipment without built-in fuses, circuit breakers or similar protective devices, the supply circuit must be fuse-protected in such a way that anyone who has access to the product, as well as the product itself, is adequately protected from injury or damage.
14. Use suitable overvoltage protection to ensure that no overvoltage (such as that caused by a bolt of lightning) can reach the product. Otherwise, the person operating the product will be exposed to the danger of an electric shock.
15. Any object that is not designed to be placed in the openings of the housing must not be used for this purpose. Doing so can cause short circuits inside the product and/or electric shocks, fire or injuries.
16. Unless specified otherwise, products are not liquid-proof (see also section "Operating states and operating positions", item 1). Therefore, the equipment must be protected against penetration by liquids. If the necessary precautions are not taken, the user may suffer electric shock or the product itself may be damaged, which can also lead to personal injury.
17. Never use the product under conditions in which condensation has formed or can form in or on the product, e.g. if the product has been moved from a cold to a warm environment. Penetration by water increases the risk of electric shock.
18. Prior to cleaning the product, disconnect it completely from the power supply (e.g. AC supply network or battery). Use a soft, non-linting cloth to clean the product. Never use chemical cleaning agents such as alcohol, acetone or diluents for cellulose lacquers.

## Operation

1. Operating the products requires special training and intense concentration. Make sure that persons who use the products are physically, mentally and emotionally fit enough to do so; otherwise, injuries or material damage may occur. It is the responsibility of the employer/operator to select suitable personnel for operating the products.

## Basic Safety Instructions

2. Before you move or transport the product, read and observe the section titled "Transport".
3. As with all industrially manufactured goods, the use of substances that induce an allergic reaction (allergens) such as nickel cannot be generally excluded. If you develop an allergic reaction (such as a skin rash, frequent sneezing, red eyes or respiratory difficulties) when using a Rohde & Schwarz product, consult a physician immediately to determine the cause and to prevent health problems or stress.
4. Before you start processing the product mechanically and/or thermally, or before you take it apart, be sure to read and pay special attention to the section titled "Waste disposal/Environmental protection", item 1.
5. Depending on the function, certain products such as RF radio equipment can produce an elevated level of electromagnetic radiation. Considering that unborn babies require increased protection, pregnant women must be protected by appropriate measures. Persons with pacemakers may also be exposed to risks from electromagnetic radiation. The employer/operator must evaluate workplaces where there is a special risk of exposure to radiation and, if necessary, take measures to avert the potential danger.
6. Should a fire occur, the product may release hazardous substances (gases, fluids, etc.) that can cause health problems. Therefore, suitable measures must be taken, e.g. protective masks and protective clothing must be worn.
7. Laser products are given warning labels that are standardized according to their laser class. Lasers can cause biological harm due to the properties of their radiation and due to their extremely concentrated electromagnetic power. If a laser product (e.g. a CD/DVD drive) is integrated into a Rohde & Schwarz product, absolutely no other settings or functions may be used as described in the product documentation. The objective is to prevent personal injury (e.g. due to laser beams).
8. EMC classes (in line with EN 55011/CISPR 11, and analogously with EN 55022/CISPR 22, EN 55032/CISPR 32)
  - Class A equipment:  
Equipment suitable for use in all environments except residential environments and environments that are directly connected to a low-voltage supply network that supplies residential buildings  
Note: Class A equipment is intended for use in an industrial environment. This equipment may cause radio disturbances in residential environments, due to possible conducted as well as radiated disturbances. In this case, the operator may be required to take appropriate measures to eliminate these disturbances.
  - Class B equipment:  
Equipment suitable for use in residential environments and environments that are directly connected to a low-voltage supply network that supplies residential buildings

### Repair and service

1. The product may be opened only by authorized, specially trained personnel. Before any work is performed on the product or before the product is opened, it must be disconnected from the AC supply network. Otherwise, personnel will be exposed to the risk of an electric shock.

## Basic Safety Instructions

- Adjustments, replacement of parts, maintenance and repair may be performed only by electrical experts authorized by Rohde & Schwarz. Only original parts may be used for replacing parts relevant to safety (e.g. power switches, power transformers, fuses). A safety test must always be performed after parts relevant to safety have been replaced (visual inspection, protective conductor test, insulation resistance measurement, leakage current measurement, functional test). This helps ensure the continued safety of the product.

### Batteries and rechargeable batteries/cells

*If the information regarding batteries and rechargeable batteries/cells is not observed either at all or to the extent necessary, product users may be exposed to the risk of explosions, fire and/or serious personal injury, and, in some cases, death. Batteries and rechargeable batteries with alkaline electrolytes (e.g. lithium cells) must be handled in accordance with the EN 62133 standard.*

- Cells must not be taken apart or crushed.
- Cells or batteries must not be exposed to heat or fire. Storage in direct sunlight must be avoided. Keep cells and batteries clean and dry. Clean soiled connectors using a dry, clean cloth.
- Cells or batteries must not be short-circuited. Cells or batteries must not be stored in a box or in a drawer where they can short-circuit each other, or where they can be short-circuited by other conductive materials. Cells and batteries must not be removed from their original packaging until they are ready to be used.
- Cells and batteries must not be exposed to any mechanical shocks that are stronger than permitted.
- If a cell develops a leak, the fluid must not be allowed to come into contact with the skin or eyes. If contact occurs, wash the affected area with plenty of water and seek medical aid.
- Improperly replacing or charging cells or batteries that contain alkaline electrolytes (e.g. lithium cells) can cause explosions. Replace cells or batteries only with the matching Rohde & Schwarz type (see parts list) in order to ensure the safety of the product.
- Cells and batteries must be recycled and kept separate from residual waste. Rechargeable batteries and normal batteries that contain lead, mercury or cadmium are hazardous waste. Observe the national regulations regarding waste disposal and recycling.

### Transport

- The product may be very heavy. Therefore, the product must be handled with care. In some cases, the user may require a suitable means of lifting or moving the product (e.g. with a lift-truck) to avoid back or other physical injuries.
- Handles on the products are designed exclusively to enable personnel to transport the product. It is therefore not permissible to use handles to fasten the product to or on transport equipment such as cranes, fork lifts, wagons, etc. The user is responsible for securely fastening the products to or on the means of transport or lifting. Observe the safety regulations of the manufacturer of the means of transport or lifting. Noncompliance can result in personal injury or material damage.
- If you use the product in a vehicle, it is the sole responsibility of the driver to drive the vehicle safely and properly. The manufacturer assumes no responsibility for accidents or collisions. Never use the product in a moving vehicle if doing so could distract the driver of the vehicle. Adequately secure the product in the vehicle to prevent injuries or other damage in the event of an accident.



## Instrucciones de seguridad elementales

### Waste disposal/Environmental protection

1. Specially marked equipment has a battery or accumulator that must not be disposed of with unsorted municipal waste, but must be collected separately. It may only be disposed of at a suitable collection point or via a Rohde & Schwarz customer service center.
2. Waste electrical and electronic equipment must not be disposed of with unsorted municipal waste, but must be collected separately.  
Rohde & Schwarz GmbH & Co. KG has developed a disposal concept and takes full responsibility for take-back obligations and disposal obligations for manufacturers within the EU. Contact your Rohde & Schwarz customer service center for environmentally responsible disposal of the product.
3. If products or their components are mechanically and/or thermally processed in a manner that goes beyond their intended use, hazardous substances (heavy-metal dust such as lead, beryllium, nickel) may be released. For this reason, the product may only be disassembled by specially trained personnel. Improper disassembly may be hazardous to your health. National waste disposal regulations must be observed.
4. If handling the product releases hazardous substances or fuels that must be disposed of in a special way, e.g. coolants or engine oils that must be replenished regularly, the safety instructions of the manufacturer of the hazardous substances or fuels and the applicable regional waste disposal regulations must be observed. Also observe the relevant safety instructions in the product documentation. The improper disposal of hazardous substances or fuels can cause health problems and lead to environmental damage.

For additional information about environmental protection, visit the Rohde & Schwarz website.

## Instrucciones de seguridad elementales

### ¡Es imprescindible leer y cumplir las siguientes instrucciones e informaciones de seguridad!

El principio del grupo de empresas Rohde & Schwarz consiste en tener nuestros productos siempre al día con los estándares de seguridad y de ofrecer a nuestros clientes el máximo grado de seguridad. Nuestros productos y todos los equipos adicionales son siempre fabricados y examinados según las normas de seguridad vigentes. Nuestro sistema de garantía de calidad controla constantemente que sean cumplidas estas normas. El presente producto ha sido fabricado y examinado según el certificado de conformidad de la UE y ha salido de nuestra planta en estado impecable según los estándares técnicos de seguridad. Para poder preservar este estado y garantizar un funcionamiento libre de peligros, el usuario deberá atenerse a todas las indicaciones, informaciones de seguridad y notas de alerta. El grupo de empresas Rohde & Schwarz está siempre a su disposición en caso de que tengan preguntas referentes a estas informaciones de seguridad.

Además queda en la responsabilidad del usuario utilizar el producto en la forma debida. Este producto está destinado exclusivamente al uso en la industria y el laboratorio o, si ha sido expresamente autorizado, para aplicaciones de campo y de ninguna manera deberá ser utilizado de modo que alguna persona/cosa pueda sufrir daño. El uso del producto fuera de sus fines definidos o sin tener en cuenta las instrucciones del fabricante queda en la responsabilidad del usuario. El fabricante no se hace en ninguna forma responsable de consecuencias a causa del mal uso del producto.















## Instrucciones de seguridad elementales

Se parte del uso correcto del producto para los fines definidos si el producto es utilizado conforme a las indicaciones de la correspondiente documentación del producto y dentro del margen de rendimiento definido (ver hoja de datos, documentación, informaciones de seguridad que siguen). El uso del producto hace necesarios conocimientos técnicos y ciertos conocimientos del idioma inglés. Por eso se debe tener en cuenta que el producto solo pueda ser operado por personal especializado o personas instruidas en profundidad con las capacidades correspondientes. Si fuera necesaria indumentaria de seguridad para el uso de productos de Rohde & Schwarz, encontraría la información debida en la documentación del producto en el capítulo correspondiente. Guarde bien las informaciones de seguridad elementales, así como la documentación del producto, y entréguelas a usuarios posteriores.

Tener en cuenta las informaciones de seguridad sirve para evitar en lo posible lesiones o daños por peligros de toda clase. Por eso es imprescindible leer detalladamente y comprender por completo las siguientes informaciones de seguridad antes de usar el producto, y respetarlas durante el uso del producto. Deberán tenerse en cuenta todas las demás informaciones de seguridad, como p. ej. las referentes a la protección de personas, que encontrarán en el capítulo correspondiente de la documentación del producto y que también son de obligado cumplimiento. En las presentes informaciones de seguridad se recogen todos los objetos que distribuye el grupo de empresas Rohde & Schwarz bajo la denominación de "producto", entre ellos también aparatos, instalaciones así como toda clase de accesorios. Los datos específicos del producto figuran en la hoja de datos y en la documentación del producto.

### Señalización de seguridad de los productos

Las siguientes señales de seguridad se utilizan en los productos para advertir sobre riesgos y peligros.

Símbolo	Significado	Símbolo	Significado
	Aviso: punto de peligro general Observar la documentación del producto		Tensión de alimentación de PUESTA EN MARCHA / PARADA
	Atención en el manejo de dispositivos de peso elevado		Indicación de estado de espera (standby)
	Peligro de choque eléctrico		Corriente continua (DC)
	Advertencia: superficie caliente		Corriente alterna (AC)
	Conexión a conductor de protección		Corriente continua / Corriente alterna (DC/AC)
	Conexión a tierra		El aparato está protegido en su totalidad por un aislamiento doble (reforzado)
	Conexión a masa		Distintivo de la UE para baterías y acumuladores  Más información en la sección "Eliminación/protección del medio ambiente", punto 1.

## Instrucciones de seguridad elementales

Símbolo	Significado	Símbolo	Significado
	Aviso: Cuidado en el manejo de dispositivos sensibles a la electrostática (ESD)		Distintivo de la UE para la eliminación por separado de dispositivos eléctricos y electrónicos  Más información en la sección "Eliminación/protección del medio ambiente", punto 2.
	Advertencia: rayo láser  Más información en la sección "Funcionamiento", punto 7.		

### Palabras de señal y su significado

En la documentación del producto se utilizan las siguientes palabras de señal con el fin de advertir contra riesgos y peligros.



Indica una situación de peligro que, si no se evita, causa lesiones graves o incluso la muerte.



Indica una situación de peligro que, si no se evita, puede causar lesiones graves o incluso la muerte.



Indica una situación de peligro que, si no se evita, puede causar lesiones leves o moderadas.



Indica información que se considera importante, pero no en relación con situaciones de peligro; p. ej., avisos sobre posibles daños materiales.

En la documentación del producto se emplea de forma sinónima el término CUIDADO.

Las palabras de señal corresponden a la definición habitual para aplicaciones civiles en el área económica europea. Pueden existir definiciones diferentes a esta definición en otras áreas económicas o en aplicaciones militares. Por eso se deberá tener en cuenta que las palabras de señal aquí descritas sean utilizadas siempre solamente en combinación con la correspondiente documentación del producto y solamente en combinación con el producto correspondiente. La utilización de las palabras de señal en combinación con productos o documentaciones que no les correspondan puede llevar a interpretaciones equivocadas y tener por consecuencia daños en personas u objetos.

### Estados operativos y posiciones de funcionamiento

*El producto solamente debe ser utilizado según lo indicado por el fabricante respecto a los estados operativos y posiciones de funcionamiento sin que se obstruya la ventilación. Si no se siguen las indicaciones del fabricante, pueden producirse choques eléctricos, incendios y/o lesiones graves con posible consecuencia de muerte. En todos los trabajos deberán ser tenidas en cuenta las normas nacionales y locales de seguridad del trabajo y de prevención de accidentes.*

## Instrucciones de seguridad elementales

1. Si no se convino de otra manera, es para los productos Rohde & Schwarz válido lo que sigue: como posición de funcionamiento se define por principio la posición con el suelo de la caja para abajo, modo de protección IP 2X, uso solamente en estancias interiores, utilización hasta 2000 m sobre el nivel del mar, transporte hasta 4500 m sobre el nivel del mar. Se aplicará una tolerancia de  $\pm 10\%$  sobre el voltaje nominal y de  $\pm 5\%$  sobre la frecuencia nominal. Categoría de sobrecarga eléctrica 2, índice de suciedad 2.
2. No sitúe el producto encima de superficies, vehículos, estantes o mesas, que por sus características de peso o de estabilidad no sean aptos para él. Siga siempre las instrucciones de instalación del fabricante cuando instale y asegure el producto en objetos o estructuras (p. ej. paredes y estantes). Si se realiza la instalación de modo distinto al indicado en la documentación del producto, se pueden causar lesiones o, en determinadas circunstancias, incluso la muerte.
3. No ponga el producto sobre aparatos que generen calor (p. ej. radiadores o calefactores). La temperatura ambiente no debe superar la temperatura máxima especificada en la documentación del producto o en la hoja de datos. En caso de sobrecalentamiento del producto, pueden producirse choques eléctricos, incendios y/o lesiones graves con posible consecuencia de muerte.

### Seguridad eléctrica

*Si no se siguen (o se siguen de modo insuficiente) las indicaciones del fabricante en cuanto a seguridad eléctrica, pueden producirse choques eléctricos, incendios y/o lesiones graves con posible consecuencia de muerte.*

1. Antes de la puesta en marcha del producto se deberá comprobar siempre que la tensión preseleccionada en el producto coincida con la de la red de alimentación eléctrica. Si es necesario modificar el ajuste de tensión, también se deberán cambiar en caso dado los fusibles correspondientes del producto.
2. Los productos de la clase de protección I con alimentación móvil y enchufe individual solamente podrán enchufarse a tomas de corriente con contacto de seguridad y con conductor de protección conectado.
3. Queda prohibida la interrupción intencionada del conductor de protección, tanto en la toma de corriente como en el mismo producto. La interrupción puede tener como consecuencia el riesgo de que el producto sea fuente de choques eléctricos. Si se utilizan cables alargadores o regletas de enchufe, deberá garantizarse la realización de un examen regular de los mismos en cuanto a su estado técnico de seguridad.
4. Si el producto no está equipado con un interruptor para desconectarlo de la red, o bien si el interruptor existente no resulta apropiado para la desconexión de la red, el enchufe del cable de conexión se deberá considerar como un dispositivo de desconexión. El dispositivo de desconexión se debe poder alcanzar fácilmente y debe estar siempre bien accesible. Si, p. ej., el enchufe de conexión a la red es el dispositivo de desconexión, la longitud del cable de conexión no debe superar 3 m). Los interruptores selectores o electrónicos no son aptos para el corte de la red eléctrica. Si se integran productos sin interruptor en bastidores o instalaciones, se deberá colocar el interruptor en el nivel de la instalación.
5. No utilice nunca el producto si está dañado el cable de conexión a red. Compruebe regularmente el correcto estado de los cables de conexión a red. Asegúrese, mediante las medidas de protección y de instalación adecuadas, de que el cable de conexión a red no pueda ser dañado o de que nadie pueda ser dañado por él, p. ej. al tropezar o por un choque eléctrico.

## Instrucciones de seguridad elementales

6. Solamente está permitido el funcionamiento en redes de alimentación TN/TT aseguradas con fusibles de 16 A como máximo (utilización de fusibles de mayor amperaje solo previa consulta con el grupo de empresas Rohde & Schwarz).
7. Nunca conecte el enchufe en tomas de corriente sucias o llenas de polvo. Introduzca el enchufe por completo y fuertemente en la toma de corriente. La no observación de estas medidas puede provocar chispas, fuego y/o lesiones.
8. No sobrecargue las tomas de corriente, los cables alargadores o las regletas de enchufe ya que esto podría causar fuego o choques eléctricos.
9. En las mediciones en circuitos de corriente con una tensión  $U_{\text{eff}} > 30 \text{ V}$  se deberán tomar las medidas apropiadas para impedir cualquier peligro (p. ej. medios de medición adecuados, seguros, limitación de tensión, corte protector, aislamiento etc.).
10. Para la conexión con dispositivos informáticos como un PC o un ordenador industrial, debe comprobarse que éstos cumplan los estándares IEC60950-1/EN60950-1 o IEC61010-1/EN 61010-1 válidos en cada caso.
11. A menos que esté permitido expresamente, no retire nunca la tapa ni componentes de la carcasa mientras el producto esté en servicio. Esto pone a descubierto los cables y componentes eléctricos y puede causar lesiones, fuego o daños en el producto.
12. Si un producto se instala en un lugar fijo, se deberá primero conectar el conductor de protección fijo con el conductor de protección del producto antes de hacer cualquier otra conexión. La instalación y la conexión deberán ser efectuadas por un electricista especializado.
13. En el caso de dispositivos fijos que no estén provistos de fusibles, interruptor automático ni otros mecanismos de seguridad similares, el circuito de alimentación debe estar protegido de modo que todas las personas que puedan acceder al producto, así como el producto mismo, estén a salvo de posibles daños.
14. Todo producto debe estar protegido contra sobretensión (debida p. ej. a una caída del rayo) mediante los correspondientes sistemas de protección. Si no, el personal que lo utilice quedará expuesto al peligro de choque eléctrico.
15. No debe introducirse en los orificios de la caja del aparato ningún objeto que no esté destinado a ello. Esto puede producir cortocircuitos en el producto y/o puede causar choques eléctricos, fuego o lesiones.
16. Salvo indicación contraria, los productos no están impermeabilizados (ver también el capítulo "Estados operativos y posiciones de funcionamiento", punto 1). Por eso es necesario tomar las medidas necesarias para evitar la entrada de líquidos. En caso contrario, existe peligro de choque eléctrico para el usuario o de daños en el producto, que también pueden redundar en peligro para las personas.
17. No utilice el producto en condiciones en las que pueda producirse o ya se hayan producido condensaciones sobre el producto o en el interior de éste, como p. ej. al desplazarlo de un lugar frío a otro caliente. La entrada de agua aumenta el riesgo de choque eléctrico.
18. Antes de la limpieza, desconecte por completo el producto de la alimentación de tensión (p. ej. red de alimentación o batería). Realice la limpieza de los aparatos con un paño suave, que no se deshilache. No utilice bajo ningún concepto productos de limpieza químicos como alcohol, acetona o diluyentes para lacas nitrocelulósicas.

## Instrucciones de seguridad elementales

### Funcionamiento

1. El uso del producto requiere instrucciones especiales y una alta concentración durante el manejo. Debe asegurarse que las personas que manejen el producto estén a la altura de los requerimientos necesarios en cuanto a aptitudes físicas, psíquicas y emocionales, ya que de otra manera no se pueden excluir lesiones o daños de objetos. El empresario u operador es responsable de seleccionar el personal usuario apto para el manejo del producto.
2. Antes de desplazar o transportar el producto, lea y tenga en cuenta el capítulo "Transporte".
3. Como con todo producto de fabricación industrial no puede quedar excluida en general la posibilidad de que se produzcan alergias provocadas por algunos materiales empleados —los llamados alérgenos (p. ej. el níquel)—. Si durante el manejo de productos Rohde & Schwarz se producen reacciones alérgicas, como p. ej. irritaciones cutáneas, estornudos continuos, enrojecimiento de la conjuntiva o dificultades respiratorias, debe avisarse inmediatamente a un médico para investigar las causas y evitar cualquier molestia o daño a la salud.
4. Antes de la manipulación mecánica y/o térmica o el desmontaje del producto, debe tenerse en cuenta imprescindiblemente el capítulo "Eliminación/protección del medio ambiente", punto 1.
5. Ciertos productos, como p. ej. las instalaciones de radiocomunicación RF, pueden a causa de su función natural, emitir una radiación electromagnética aumentada. Deben tomarse todas las medidas necesarias para la protección de las mujeres embarazadas. También las personas con marcapasos pueden correr peligro a causa de la radiación electromagnética. El empresario/operador tiene la obligación de evaluar y señalizar las áreas de trabajo en las que exista un riesgo elevado de exposición a radiaciones.
6. Tenga en cuenta que en caso de incendio pueden desprenderse del producto sustancias tóxicas (gases, líquidos etc.) que pueden generar daños a la salud. Por eso, en caso de incendio deben usarse medidas adecuadas, como p. ej. máscaras antigás e indumentaria de protección.
7. Los productos con láser están provistos de indicaciones de advertencia normalizadas en función de la clase de láser del que se trate. Los rayos láser pueden provocar daños de tipo biológico a causa de las propiedades de su radiación y debido a su concentración extrema de potencia electromagnética. En caso de que un producto Rohde & Schwarz contenga un producto láser (p. ej. un lector de CD/DVD), no debe usarse ninguna otra configuración o función aparte de las descritas en la documentación del producto, a fin de evitar lesiones (p. ej. debidas a irradiación láser).
8. Clases de compatibilidad electromagnética (conforme a EN 55011 / CISPR 11; y en analogía con EN 55022 / CISPR 22, EN 55032 / CISPR 32)
  - Aparato de clase A:  
Aparato adecuado para su uso en todos los entornos excepto en los residenciales y en aquellos conectados directamente a una red de distribución de baja tensión que suministra corriente a edificios residenciales.  
Nota: Los aparatos de clase A están destinados al uso en entornos industriales. Estos aparatos pueden causar perturbaciones radioeléctricas en entornos residenciales debido a posibles perturbaciones guiadas o radiadas. En este caso, se le podrá solicitar al operador que tome las medidas adecuadas para eliminar estas perturbaciones.
  - Aparato de clase B:  
Aparato adecuado para su uso en entornos residenciales, así como en aquellos conectados directamente a una red de distribución de baja tensión que suministra corriente a edificios residenciales.

## Instrucciones de seguridad elementales

### Reparación y mantenimiento

1. El producto solamente debe ser abierto por personal especializado con autorización para ello. Antes de manipular el producto o abrirlo, es obligatorio desconectarlo de la tensión de alimentación, para evitar toda posibilidad de choque eléctrico.
2. El ajuste, el cambio de partes, el mantenimiento y la reparación deberán ser efectuadas solamente por electricistas autorizados por Rohde & Schwarz. Si se reponen partes con importancia para los aspectos de seguridad (p. ej. el enchufe, los transformadores o los fusibles), solamente podrán ser sustituidos por partes originales. Después de cada cambio de partes relevantes para la seguridad deberá realizarse un control de seguridad (control a primera vista, control del conductor de protección, medición de resistencia de aislamiento, medición de la corriente de fuga, control de funcionamiento). Con esto queda garantizada la seguridad del producto.

### Baterías y acumuladores o celdas

*Si no se siguen (o se siguen de modo insuficiente) las indicaciones en cuanto a las baterías y acumuladores o celdas, pueden producirse explosiones, incendios y/o lesiones graves con posible consecuencia de muerte. El manejo de baterías y acumuladores con electrolitos alcalinos (p. ej. celdas de litio) debe seguir el estándar EN 62133.*

1. No deben desmontarse, abrirse ni triturarse las celdas.
2. Las celdas o baterías no deben someterse a calor ni fuego. Debe evitarse el almacenamiento a la luz directa del sol. Las celdas y baterías deben mantenerse limpias y secas. Limpiar las conexiones sucias con un paño seco y limpio.
3. Las celdas o baterías no deben cortocircuitarse. Es peligroso almacenar las celdas o baterías en estuches o cajones en cuyo interior puedan cortocircuitarse por contacto recíproco o por contacto con otros materiales conductores. No deben extraerse las celdas o baterías de sus embalajes originales hasta el momento en que vayan a utilizarse.
4. Las celdas o baterías no deben someterse a impactos mecánicos fuertes indebidos.
5. En caso de falta de estanqueidad de una celda, el líquido vertido no debe entrar en contacto con la piel ni los ojos. Si se produce contacto, lavar con agua abundante la zona afectada y avisar a un médico.
6. En caso de cambio o recarga inadecuados, las celdas o baterías que contienen electrolitos alcalinos (p. ej. las celdas de litio) pueden explotar. Para garantizar la seguridad del producto, las celdas o baterías solo deben ser sustituidas por el tipo Rohde & Schwarz correspondiente (ver lista de recambios).
7. Las baterías y celdas deben reciclarse y no deben tirarse a la basura doméstica. Las baterías o acumuladores que contienen plomo, mercurio o cadmio deben tratarse como residuos especiales. Respete en esta relación las normas nacionales de eliminación y reciclaje.

### Transporte

1. El producto puede tener un peso elevado. Por eso es necesario desplazarlo o transportarlo con precaución y, si es necesario, usando un sistema de elevación adecuado (p. ej. una carretilla elevadora), a fin de evitar lesiones en la espalda u otros daños personales.

## Instrucciones de seguridad elementales

2. Las asas instaladas en los productos sirven solamente de ayuda para el transporte del producto por personas. Por eso no está permitido utilizar las asas para la sujeción en o sobre medios de transporte como p. ej. grúas, carretillas elevadoras de horquilla, carros etc. Es responsabilidad suya fijar los productos de manera segura a los medios de transporte o elevación. Para evitar daños personales o daños en el producto, siga las instrucciones de seguridad del fabricante del medio de transporte o elevación utilizado.
3. Si se utiliza el producto dentro de un vehículo, recae de manera exclusiva en el conductor la responsabilidad de conducir el vehículo de manera segura y adecuada. El fabricante no asumirá ninguna responsabilidad por accidentes o colisiones. No utilice nunca el producto dentro de un vehículo en movimiento si esto pudiera distraer al conductor. Asegure el producto dentro del vehículo debidamente para evitar, en caso de un accidente, lesiones u otra clase de daños.

### Eliminación/protección del medio ambiente

1. Los dispositivos marcados contienen una batería o un acumulador que no se debe desechar con los residuos domésticos sin clasificar, sino que debe ser recogido por separado. La eliminación se debe efectuar exclusivamente a través de un punto de recogida apropiado o del servicio de atención al cliente de Rohde & Schwarz.
2. Los dispositivos eléctricos usados no se deben desechar con los residuos domésticos sin clasificar, sino que deben ser recogidos por separado.  
Rohde & Schwarz GmbH & Co.KG ha elaborado un concepto de eliminación de residuos y asume plenamente los deberes de recogida y eliminación para los fabricantes dentro de la UE. Para desechar el producto de manera respetuosa con el medio ambiente, dirijase a su servicio de atención al cliente de Rohde & Schwarz.
3. Si se trabaja de manera mecánica y/o térmica cualquier producto o componente más allá del funcionamiento previsto, pueden liberarse sustancias peligrosas (polvos con contenido de metales pesados como p. ej. plomo, berilio o níquel). Por eso el producto solo debe ser desmontado por personal especializado con formación adecuada. Un desmontaje inadecuado puede ocasionar daños para la salud. Se deben tener en cuenta las directivas nacionales referentes a la eliminación de residuos.
4. En caso de que durante el trato del producto se formen sustancias peligrosas o combustibles que deban tratarse como residuos especiales (p. ej. refrigerantes o aceites de motor con intervalos de cambio definidos), deben tenerse en cuenta las indicaciones de seguridad del fabricante de dichas sustancias y las normas regionales de eliminación de residuos. Tenga en cuenta también en caso necesario las indicaciones de seguridad especiales contenidas en la documentación del producto. La eliminación incorrecta de sustancias peligrosas o combustibles puede causar daños a la salud o daños al medio ambiente.

Se puede encontrar más información sobre la protección del medio ambiente en la página web de Rohde & Schwarz.



# Quality management and environmental management

Certified Quality System  
**ISO 9001**

Certified Environmental System  
**ISO 14001**

## Sehr geehrter Kunde,

Sie haben sich für den Kauf eines Rohde&Schwarz Produktes entschieden. Sie erhalten damit ein nach modernsten Fertigungsmethoden hergestelltes Produkt. Es wurde nach den Regeln unserer Qualitäts- und Umweltmanagementsysteme entwickelt, gefertigt und geprüft. Rohde&Schwarz ist unter anderem nach den Managementsystemen ISO9001 und ISO 14001 zertifiziert.

## Der Umwelt verpflichtet

- Energie-effiziente, RoHS-konforme Produkte
- Kontinuierliche Weiterentwicklung nachhaltiger Umweltkonzepte
- ISO 14001-zertifiziertes Umweltmanagementsystem

## Dear customer,

You have decided to buy a Rohde&Schwarz product. This product has been manufactured using the most advanced methods. It was developed, manufactured and tested in compliance with our quality management and environmental management systems. Rohde&Schwarz has been certified, for example, according to the ISO9001 and ISO 14001 management systems.

## Environmental commitment

- Energy-efficient products
- Continuous improvement in environmental sustainability
- ISO 14001-certified environmental management system

## Cher client,

Vous avez choisi d'acheter un produit Rohde&Schwarz. Vous disposez donc d'un produit fabriqué d'après les méthodes les plus avancées. Le développement, la fabrication et les tests de ce produit ont été effectués selon nos systèmes de management de qualité et de management environnemental. La société Rohde&Schwarz a été homologuée, entre autres, conformément aux systèmes de management ISO 9001 et ISO 14001.

## Engagement écologique

- Produits à efficience énergétique
- Amélioration continue de la durabilité environnementale
- Système de management environnemental certifié selon ISO 14001



# Customer Support

## Technical support – where and when you need it

For quick, expert help with any Rohde & Schwarz equipment, contact one of our Customer Support Centers. A team of highly qualified engineers provides telephone support and will work with you to find a solution to your query on any aspect of the operation, programming or applications of Rohde & Schwarz equipment.

## Up-to-date information and upgrades

To keep your instrument up-to-date and to be informed about new application notes related to your instrument, please send an e-mail to the Customer Support Center stating your instrument and your wish. We will take care that you will get the right information.

### Europe, Africa, Middle East

Phone +49 89 4129 12345  
[customersupport@rohde-schwarz.com](mailto:customersupport@rohde-schwarz.com)

### North America

Phone 1-888-TEST-RSA (1-888-837-8772)  
[customer.support@rsa.rohde-schwarz.com](mailto:customer.support@rsa.rohde-schwarz.com)

### Latin America

Phone +1-410-910-7988  
[customersupport.la@rohde-schwarz.com](mailto:customersupport.la@rohde-schwarz.com)

### Asia/Pacific

Phone +65 65 13 04 88  
[customersupport.asia@rohde-schwarz.com](mailto:customersupport.asia@rohde-schwarz.com)

### China

Phone +86-800-810-8228 /  
+86-400-650-5896  
[customersupport.china@rohde-schwarz.com](mailto:customersupport.china@rohde-schwarz.com)



## Tabbed Divider Overview

### Volume 1

**How to Use this Manual  
Contents**

**Data Sheet  
Supplement to Data Sheet**

**Safety Instructions  
Certificate of quality  
EC Certificate of Conformity**

Tabbed Divider

<b>1</b>	<b>Chapter 1:</b>	<b>Preparation for Use</b>
<b>2</b>	<b>Chapter 2:</b>	<b>Manual Operation</b>
<b>10</b>	<b>Index</b>	

### Volume 2

**How to Use this Manual  
Contents  
Safety Instructions**

Tabbed Divider

<b>3</b>	<b>Chapter 3:</b>	<b>Remote Control</b>
<b>4</b>	<b>Chapter 4:</b>	<b>Maintenance</b>
<b>5</b>	<b>Chapter 5:</b>	<b>Performance Test</b>
<b>6</b>	<b>Annex A:</b>	<b>Interfaces</b>
<b>7</b>	<b>Annex B:</b>	<b>List of Error Messages</b>
<b>8</b>	<b>Annex C:</b>	<b>List of Commands</b>
<b>9</b>	<b>Annex D:</b>	<b>Programming Example</b>
<b>10</b>	<b>Index</b>	

## Introduction on how to use the manual

This operating manual contains essential information on commissioning, manual control, remote control, maintenance and checking the rated specifications of SMIQ as well as all specifications of the unit and available options.

### The following models and options are described in this manual:

- SMIQ02B – Vector Signal Generator 300 kHz to 2.2 GHz
- SMIQ03B – Vector Signal Generator 300 kHz to 3.3 GHz
- SMIQ04B – Vector Signal Generator 300 kHz to 4.4 GHz
- SMIQ06B – Vector Signal Generator 300 kHz to 6.4 GHz
  
- Option SM-B1 – Reference Oscillator OCXO
- Option SM-B5 – FM/PM Modulator
- Option SMIQB11 – Data Generator
- Option SMIQB12 – Memory Extension to Data Generator
- Option SMIQB14 – Fading Simulator FSIM1
- Option SMIQB15 – Second Fading Simulator FSIM2
- Option SMIQB17 – Noise Generator and Distortion Simulator
- Option SMIQB19 – Rear Panel Connections for RF and LF
- Option SMIQB20 – Modulation Coder
- Option SMIQB21 – Bit Error Rate Test
- Option SMIQB42 – Digital Standard IS-95 CDMA
- Option SMIQB43 – Digital Standard W-CDMA
- Option SMIQB45 – Digital Standard 3 GPP W-CDMA
- Option SMIQB47 – LOW ACP Filter
- Option SMIQB48 – Enhanced Functions für 3GPP W-CDMA
- Option SMIQB49 – Dynamic Fading
- Option SMIQB60 – Arbitrary Waveform Generator

### The chapters with associated contents are as follows:

<b>Data sheets</b>	list guaranteed specifications for the functions and characteristics of the unit and its options.
<b>Chapter 1</b>	provides information on putting the unit into operation (AC supply connection, switch-on/off), functional test, preset settings, fitting the options and mounting the unit into a 19" rack.
<b>Chapter 2</b>	explains the <b>manual control</b> of SMIQ. It contains front and rear panel views, describes the control elements as well as connectors, provides a short introduction with sample settings for first-time users. It also explains how to change parameters and the use of the list editor and gives an overview of the menus for the functions covered by the unit and its options. It also presents the functions and menus of the unit and its options (frequency and level setting, analog and digital modulation, ARB, external modulation source AMIQ, fading simulation, noise generation and distortion simulation, BERT, sweep, LIST mode, memory sequence and general functions not relating to signal generation).

<b>Chapter 3</b>	provides information on <b>remote control</b> of SMIQ. It informs about basics like IEC/IEEE bus, RS-232C interface, interface and device-dependent messages, command processing, status reporting system etc. It also includes an overview of each command system and describes all commands available in the unit and its options.
<b>Chapter 4</b>	informs about preventive maintenance and functional tests.
<b>Chapter 5</b>	contains information on how to check the rated specifications (required test equipment, test setup, test procedure) and on the performance test report.
<b>Annex A</b>	provides information on interfaces.
<b>Annex B</b>	contains a list of SCPI- and SMIQ-specific error messages displayed by the unit.
<b>Annex C</b>	provides an alphabetical list of commands.
<b>Annex D</b>	gives programming examples for remote control.
<b>Index</b>	provides the index with entries in alphabetical order.



## Safety Instructions

### WARNING



*Danger of injuries*

*When removing the rear feet, the unit can slip out of the cabinet.*

*Put the unit onto the front handles, before removing the rear feet and taking off the cabinet. Thus the risk of personal injuries and damages to the unit is avoided.*

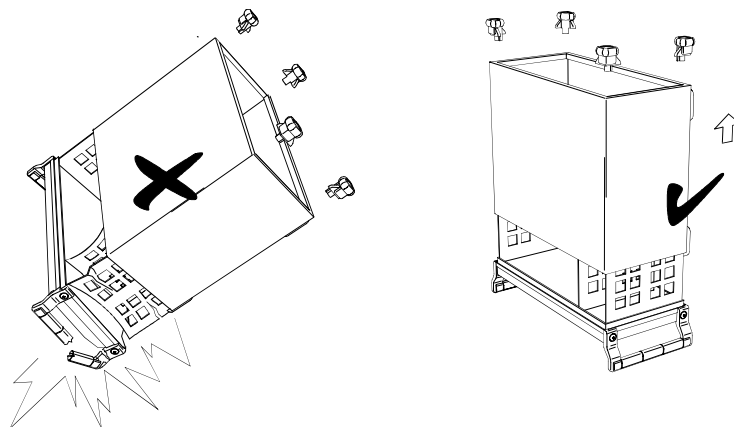

*When mounting the cabinet take care not to pen in the fingers. Also pay attention not to damage or pull off cables. Screw the rear feet back on immediately after mounting the cabinet. Do not move the unit with the rear feet missing.*

### ATTENTION



*To avoid damage of electronic components, the operational site must be protected against electrostatic discharge (ESD).*

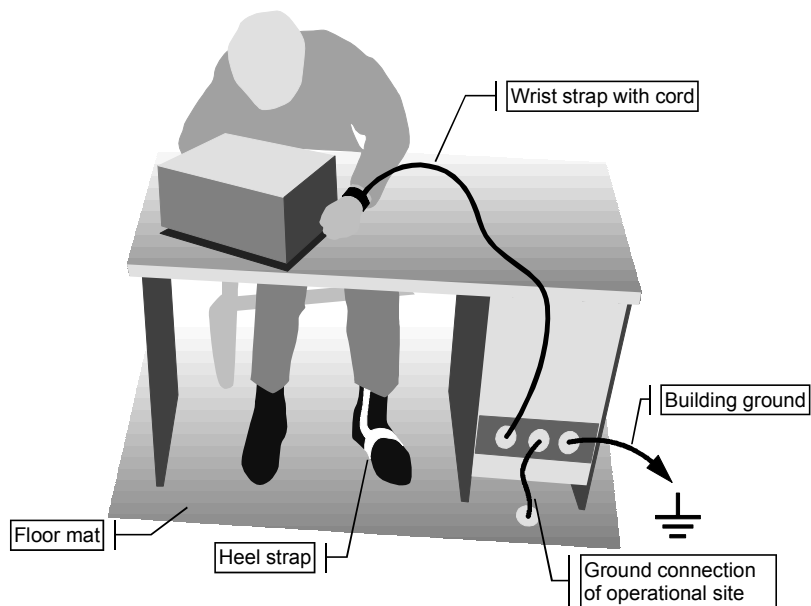

*The following two methods of ESD protection may be used together or separately:*

- *Wrist strap with cord to ground connection*
- *Conductive floor mat and heel strap combination*

# Contents

<b>1</b>	<b>Preparation for Use .....</b>	<b>1.2</b>
<b>1.1</b>	<b>Putting into Operation.....</b>	<b>1.2</b>
1.1.1	Supply Voltage .....	1.2
1.1.2	Switching On/Off the Instrument .....	1.2
1.1.3	Initial Status.....	1.3
1.1.4	Setting Contrast and Brightness of the Display.....	1.3
1.1.5	RAM with Battery Back-Up.....	1.3
1.1.6	Preset Setting.....	1.4
<b>1.2</b>	<b>Functional Test .....</b>	<b>1.4</b>
<b>1.3</b>	<b>Fitting the Options.....</b>	<b>1.5</b>
1.3.1	Opening the Casing.....	1.5
1.3.2	Overview of the Slots .....	1.6
1.3.3	Option SM-B1 - Reference Oscillator OCXO .....	1.6
1.3.4	Option SM-B5 - FM/PM Modulator .....	1.8
1.3.5	Option SMIQB11 - Data Generator .....	1.9
1.3.6	Option SMIQB12 - Memory Extension to Data Generator .....	1.9
1.3.7	Option SMIQB14 - Fading Simulator FSIM1 .....	1.10
1.3.8	Option SMIQB15 - Second Fading Simulator (FSIM2) .....	1.12
1.3.9	Option SMIQB17 - Noise Generator and Distortion Simulator .....	1.14
1.3.10	Option SMIQB20 - Modulation Coder.....	1.15
1.3.11	Option SMIQB21 - Bit Error Rate Test .....	1.16
1.3.12	Other Software Options.....	1.17
1.3.13	Option SMIQB19 - Rear Panel Connections for RF and LF.....	1.18
<b>1.4</b>	<b>Mounting into a 19" Rack .....</b>	<b>1.18</b>



<b>2</b>	<b>Operation .....</b>	<b>2.1</b>
<b>2.1</b>	<b>Front and Rear Panel .....</b>	<b>2.1</b>
2.1.1	Display.....	2.1
2.1.2	Controls and Inputs/Outputs of the Front Panel.....	2.3
2.1.3	Elements of the Rear Panel .....	2.13
<b>2.2</b>	<b>Basic Operating Steps .....</b>	<b>2.22</b>
2.2.1	Design of the Display .....	2.22
2.2.2	Calling the Menus.....	2.23
2.2.3	Selection and Change of Parameters .....	2.24
2.2.4	Triggering Action .....	2.25
2.2.5	Quick Selection of Menu (QUICK SELECT) .....	2.25
2.2.6	Use of [FREQ] and [LEVEL] Keys .....	2.26
2.2.7	Use of [RF ON/OFF] and [MOD ON/OFF] Keys .....	2.26
2.2.8	[ENTER] Key – Special Toggle Function .....	2.26
2.2.9	Changing Unit of Level .....	2.26
2.2.10	Correction of Input.....	2.27
2.2.11	Sample Setting for First Users .....	2.27
2.2.12	List Editor .....	2.32
	2.2.12.1 Select and Generate - SELECT LIST .....	2.33
	2.2.12.2 Deletion of Lists - DELETE LIST .....	2.34
	2.2.12.3 Edition of Lists.....	2.35
	2.2.12.4 Pattern Setting to Operate the List Editor .....	2.39
2.2.12	Save/Recall - Storing/Calling of Instrument Settings .....	2.43
<b>2.3</b>	<b>Menu Summary .....</b>	<b>2.44</b>
<b>2.4</b>	<b>RF Frequency.....</b>	<b>2.45</b>
2.4.1	Frequency Offset.....	2.46
<b>2.5</b>	<b>RF Level.....</b>	<b>2.47</b>
2.5.1	Level Offset .....	2.49
2.5.2	Interrupt-free Level Setting.....	2.50
2.5.3	Switching On/Off Internal Level Control .....	2.50
2.5.4	User Correction (UCOR).....	2.52
2.5.5	EMF .....	2.53
2.5.6	[RF ON / OFF]-Key.....	2.54
2.5.7	Reset Overload Protection .....	2.54
<b>2.6</b>	<b>Modulation - General.....</b>	<b>2.55</b>
2.6.1	Modulation Sources.....	2.55
2.6.2	LF Generator .....	2.57
2.6.3	Simultaneous Modulation .....	2.57
2.6.4	[MOD ON/OFF] Key .....	2.58
<b>2.7</b>	<b>Analog Modulations .....</b>	<b>2.59</b>
2.7.1	Amplitude Modulation.....	2.59
2.7.2	Broadband AM (BB-AM).....	2.60
2.7.3	Frequency Modulation .....	2.61
	2.7.3.1 FM Deviation Limits .....	2.62

2.7.3.2	Preemphasis .....	2.62
2.7.4	Phase Modulation.....	2.63
2.7.4.1	PM Deviation Limits .....	2.64
2.7.5	Pulse Modulation.....	2.65
<b>2.8</b>	<b>Vector Modulation .....</b>	<b>2.66</b>
2.8.1	I/Q Impairment .....	2.69
<b>2.9</b>	<b>Fading Simulation .....</b>	<b>2.70</b>
2.9.1	Output Power with Fading .....	2.71
2.9.2	Two-Channel Fading .....	2.71
2.9.3	Correlation between Paths .....	2.72
2.9.4	Menu FADING SIM .....	2.72
2.9.4.1	Menu STANDARD FADING .....	2.73
2.9.4.2	Menu FINE DELAY .....	2.78
2.9.4.3	Menu MOVING DELAY.....	2.81
2.9.4.4	Menu BIRTH-DEATH.....	2.83
2.9.5	Test procedure .....	2.85
<b>2.10</b>	<b>Digital Modulation .....</b>	<b>2.86</b>
2.10.1	Digital Modulation Methods and Coding.....	2.87
2.10.1.1	PSK and QAM Modulation .....	2.87
2.10.1.2	Modulation $\pi/4$ DQPSK.....	2.88
2.10.1.3	FSK Modulation .....	2.89
2.10.1.4	Coding.....	2.89
2.10.1.5	Setting Conflicts .....	2.91
2.10.2	Internal Modulation Data and Control Signals .....	2.92
2.10.3	Internal PRBS Data and Pattern .....	2.94
2.10.4	Digital Data and Clock output Signals .....	2.95
2.10.4.1	Serial Interfaces DATA, BIT CLOCK and SYMBOL CLOCK.....	2.95
2.10.4.2	Parallel Interfaces DATA and SYMBOL CLOCK .....	2.95
2.10.5	External Modulation Data and Control Signals.....	2.95
2.10.5.1	External Serial Modulation Data .....	2.96
2.10.5.2	External Parallel Modulation Data.....	2.97
2.10.5.3	Asynchronous Interface for External Modulation Data .....	2.98
2.10.5.4	External Control Signals .....	2.98
2.10.6	Envelope Control.....	2.99
2.10.7	Clock Signals.....	2.100
2.10.8	RF Level For Digital Modulation .....	2.100
2.10.9	Digital Modulation Menu .....	2.101
<b>2.11</b>	<b>Digital Standard PHS.....</b>	<b>2.115</b>
2.11.1	Sync and Trigger Signals .....	2.116
2.11.2	PN Generators as Internal Data Source .....	2.117
2.11.3	Lists as Internal Data Source .....	2.118
2.11.4	External Modulation Data .....	2.118
2.11.5	Menu DIGITAL STANDARD - PHS.....	2.119
<b>2.12</b>	<b>Digital Standard IS-95 CDMA.....</b>	<b>2.130</b>
2.12.1	Sync and Trigger Signals .....	2.133
2.12.2	PRBS Data Source in Forward Link.....	2.134
2.12.3	PN Generators as Internal Data Source for Reverse Link .....	2.135

2.12.4	Menu IS-95 CDMA Standard - Forward Link Signal.....	2.136
2.12.5	Menu IS-95 CDMA Standard - Reverse Link Signal without Channel Coding ....	2.146
2.12.6	Menu IS-95 CDMA Standard - Reverse Link Signal with Channel Coding .....	2.148
<b>2.13</b>	<b>Digital Standard W-CDMA (NTT DoCoMo/ARIB 0.0) .....</b>	<b>2.150</b>
2.13.1	Sync and Trigger Signals .....	2.152
2.13.2	PN Generators as Internal Data Source .....	2.153
2.13.3	Lists as an Internal Data Source .....	2.154
2.13.4	Menu W-CDMA Standard - Downlink and Uplink Signals without IQ Multiplex ...	2.154
2.13.5	Menu W-CDMA Standard - Uplink Signals with IQ Multiplex .....	2.165
<b>2.14</b>	<b>Digital Standard 3GPP W-CDMA (FDD) .....</b>	<b>2.169</b>
2.14.1	Description of Mobile Radio Transmission Method 3GPP W-CDMA.....	2.169
2.14.1.1	System Components .....	2.171
2.14.2	Generation of 3GPP W-CDMA Signals.....	2.177
2.14.2.1	Menu WCDMA/3GPP .....	2.179
2.14.2.2	WCDMA/3GPP Menu - Para. Predef. Submenu .....	2.189
2.14.2.3	WCDMA/3GPP Menu - Display of CCDF .....	2.191
2.14.2.4	WCDMA/3GPP Menu – Displaying Constellation Diagrams .....	2.192
2.14.2.5	WCDMA/3GPP Menu - BS Configuration Submenu .....	2.193
2.14.2.6	WCDMA/3GPP Menu - MS Configuration Submenu.....	2.199
2.14.2.7	WCDMA/3GPP – Multi Channel Edit Menu.....	2.208
2.14.2.8	WCDMA/3GPP – Display of Channel Graph Menu .....	2.210
2.14.2.9	WCDMA/3GPP Menu – Display of Code Domain and Code Domain Conflicts .....	2.211
2.14.2.10	Effect of CLIPPING LEVEL Parameter on Signal.....	2.213
2.14.2.11	Synchronization and Trigger Signals .....	2.215
2.14.2.12	Preset/Default Values .....	2.216
2.14.3	Background Information for the Generation of 3GPP W-CDMA Signals.....	2.219
2.14.3.1	3GPP W-CDMA Signals in Time Domain.....	2.219
2.14.3.2	3GPP W-CDMA Signals in the Frequency Range.....	2.225
2.14.3.3	Effect of Data Source on the 3GPP W-CDMA Signal.....	2.225
2.14.3.3.1	Two DPCHs with Uncorrelated Data .....	2.226
2.14.3.3.2	Two DPCHs with Same Data .....	2.226
2.14.3.3.3	16 DPCHs with Uncorrelated Data.....	2.227
2.14.3.3.4	16 DPCHs with same Data.....	2.228
2.14.3.3.5	Use of Timing Offset .....	2.229
2.14.3.4	Effects on Crest Factor .....	2.230
2.14.3.5	Orthogonality of Channels .....	2.230
2.14.3.5.1	Ideal Scenario.....	2.230
2.14.3.5.2	Real Scenario.....	2.230
2.14.3.5.3	Effect of SCH.....	2.231
2.14.3.5.4	Effect of S-CCPCH and the Other Downlink Channels.....	2.231
2.14.3.5.5	Effect of PRACH and PCPCH .....	2.231
2.14.3.5.6	Effect of Scrambling Code .....	2.232
2.14.3.5.7	Effect of Symbol Rates and Channelization Code Numbers.....	2.232
2.14.3.6	Simulation of Special Scenarios .....	2.234
2.14.3.6.1	Standard Base Station.....	2.234
2.14.3.6.2	Base Station with More Than 128 DPCHs .....	2.234
2.14.3.6.3	Base Stations with Spreading Codes Used Several Times.....	2.235
2.14.3.6.4	Several Base Stations .....	2.235

<b>2.15</b>	<b>Enhanced Functions For Digital Standard 3GPP W-CDMA (FDD)</b> .....	<b>2.236</b>
2.15.1	Test Setup .....	2.236
2.15.2	Branching to Menus SMIQB48 of Digital Standard 3GPP WCDMA .....	2.237
2.15.3	Enhanced Channels BS1/MS1 .....	2.238
2.15.3.1	Downlink .....	2.240
2.15.3.1.1	P-CCPCH/BCH with System Frame Number .....	2.241
2.15.3.1.2	Channel Coding .....	2.243
2.15.3.1.3	Bit Error Insertion .....	2.244
2.15.3.1.4	External Power Control .....	2.245
2.15.1.1.5	Further Setting of Enhanced Channels Menu .....	2.248
2.15.1.2	Uplink .....	2.253
2.15.1.3	Display of External Power Control Mode of Four Enhanced Channels .....	2.256
2.15.4	OCNS Channels .....	2.257
2.15.4.1	OCNS Menu .....	2.257
2.15.1.2	Test of Maximum Input Level with SMIQ .....	2.259
2.15.1.3	Favourable Sequence Length for OCNS Measurement .....	2.260
2.15.5	Additional MS Based On MS4 .....	2.260
<b>2.16</b>	<b>Digital Standard NADC</b> .....	<b>2.262</b>
2.16.1	Sync and Trigger Signals .....	2.263
2.16.2	PN Generators as Internal Data Source .....	2.264
2.16.3	Lists as Internal Data Source .....	2.265
2.16.4	External Modulation Data .....	2.265
2.16.5	Menu DIGITAL STANDARD - NADC .....	2.266
<b>2.17</b>	<b>Digital Standard PDC</b> .....	<b>2.279</b>
2.17.1	Sync and Trigger Signals .....	2.280
2.17.2	PN Generators as Internal Data Source .....	2.281
2.17.3	Lists as Internal Data Source .....	2.282
2.17.4	External Modulation Data .....	2.282
2.17.5	Menu DIGITAL STANDARD - PDC .....	2.283
<b>2.18</b>	<b>Digital Standard GSM/EDGE</b> .....	<b>2.301</b>
2.18.1	Sync and Trigger Signals .....	2.302
2.18.2	PN Generators as Internal Data Source .....	2.303
2.18.3	Lists as Internal Data Source .....	2.304
2.18.4	External Modulation Data .....	2.304
2.18.5	Menu DIGITAL STANDARD - GSM/EDGE .....	2.305
<b>2.19</b>	<b>Digital Standard DECT</b> .....	<b>2.318</b>
2.19.1	Sync and Trigger Signals .....	2.319
2.19.2	PN Generators as Internal Data Source .....	2.320
2.19.3	Lists as Internal Data Source .....	2.321
2.19.4	External Modulation Data .....	2.321
2.19.5	Menu DIGITAL STANDARD - DECT .....	2.322
<b>2.20</b>	<b>Digital Standard GPS</b> .....	<b>2.334</b>
2.20.1	Description of Global Positioning System (GPS) .....	2.334
2.20.2	GPS Menu .....	2.335
2.20.3	Instructions for Generating GPS Signals .....	2.339

<b>2.21</b>	<b>Arbitrary Waveform Generator ARB .....</b>	<b>2.341</b>
2.21.1	Function.....	2.341
2.19.1.1	Use of WinIQSIM.....	2.344
2.21.2	ARB MOD Menu.....	2.345
2.21.2.1	ARB MOD - TRIGGER Menu .....	2.347
2.21.2.2	ARB MOD - SELECT WAVEFORM Menu .....	2.349
2.21.2.3	ARB MOD - DELETE WAVEFORM Menu .....	2.352
2.21.2.4	ARB MOD - SET SMIQ ACCORDING TO WAVEFORM Menu .....	2.352
2.21.2.5	ARB MOD - CLOCK... Menu.....	2.354
2.21.2.6	ARB MOD - IQ OUTPUT... Menu .....	2.355
<b>2.22</b>	<b>External Modulation Source AMIQ.....</b>	<b>2.356</b>
<b>2.23</b>	<b>Bit Error Rate Test.....</b>	<b>2.368</b>
2.23.1	Bit Error Rate Measurement with PN Sequences (BER) .....	2.369
2.23.1.1	Operating Menu .....	2.369
2.23.1.2	Signal Path and Waveform .....	2.373
2.23.1.3	Test Method .....	2.374
	PRBS Polynomials.....	2.375
	Measurement Result, Accuracy, Measurement Time.....	2.376
	Possible Problems with BER Measurement and Related Solutions .....	2.377
2.23.2	Block Error Rate Measurement (BLER) .....	2.378
2.23.2.1	Operating Menu .....	2.378
2.23.2.2	CRC Polynomial.....	2.380
2.23.2.3	Measurement Result, Accuracy, Measurement Time.....	2.380
2.23.2.4	Possible BLER Measurement Problems and Solutions.....	2.382
<b>2.24</b>	<b>Noise Generator and Distortion Simulator.....</b>	<b>2.383</b>
2.24.1	Setting NOISE/DIST Menu.....	2.384
2.24.2	Loading New Distortion Characteristics .....	2.387
2.24.3	Level Correction of the Distortion Simulator.....	2.388
2.24.4	Calculation of the Distortion Characteristic from Polynomial Equations .....	2.390
<b>2.25</b>	<b>LF Output .....</b>	<b>2.391</b>
<b>2.26</b>	<b>Sweep .....</b>	<b>2.392</b>
2.26.1	Setting the Sweep Range (START, STOP, CENTER and SPAN).....	2.392
2.26.2	Selecting the Sweep Run (SPACING LIN, LOG) .....	2.393
2.26.3	Operating Modes (MODE) .....	2.393
2.26.4	Trigger Input.....	2.394
2.26.5	Sweep Outputs.....	2.394
2.26.6	RF Sweep.....	2.396
2.26.7	LEVEL Sweep .....	2.398
2.26.8	LF Sweep .....	2.399
<b>2.27</b>	<b>LIST Mode .....</b>	<b>2.401</b>
2.27.1	Operating Modes (MODE) .....	2.401
2.27.2	Inputs/Outputs.....	2.402
<b>2.28</b>	<b>Memory Sequence.....</b>	<b>2.406</b>

---

<b>2.29 Utilities</b> .....	<b>2.410</b>
2.29.1 IEC-Bus Address (SYSTEM-GPIB).....	2.410
2.29.2 Parameter of the RS232 Interface (SYSTEM-RS232).....	2.411
2.29.3 Parameter of the SER DATA Input (SYSTEM-SERDATA).....	2.412
2.29.4 Suppressing Indications and Deleting Memories (SYSTEM-SECURITY) .....	2.413
2.29.5 Indication of the IEC-Bus Language (LANGUAGE) .....	2.414
2.29.6 Reference Frequency Internal/External (REF OSC).....	2.414
2.29.7 Phase of the Output Signal (PHASE).....	2.415
2.29.8 Password Input With Functions Protected (PROTECT) .....	2.416
2.29.9 Calibration (CALIB) .....	2.417
2.29.10 Indications of Module Variants (DIAG-CONFIG).....	2.424
2.29.11 Voltage Indication of Test Points (DIAG-TPOINT).....	2.425
2.29.12 Measurement of CARRIER/NOISE RATIO (DIAG-C/N MEAS).....	2.426
2.29.13 Indications of Service Data (DIAG-PARAM) .....	2.427
2.29.14 Test (TEST).....	2.427
2.29.15 Assigning Modulations to the [MOD ON/OFF] Key (MOD-KEY).....	2.428
2.29.16 Setting Auxiliary Inputs/Outputs (AUX-I/O) .....	2.429
2.29.17 Switching On/Off Beeper (BEEPER).....	2.430
2.29.18 Installation of Software Option .....	2.431
<b>2.30 The Help System</b> .....	<b>2.432</b>
<b>2.31 Status</b> .....	<b>2.432</b>
<b>2.32 Error Messages</b> .....	<b>2.433</b>

<b>3</b>	<b>Remote Control.....</b>	<b>3.1</b>
<b>3.1</b>	<b>Brief Instructions.....</b>	<b>3.1</b>
3.1.1	IEC-Bus.....	3.1
3.1.2	RS-232 Interface.....	3.2
<b>3.2</b>	<b>Switchover to Remote Control.....</b>	<b>3.2</b>
3.2.1	Remote Control via IEC Bus.....	3.3
3.2.1.1	Setting the Device Address.....	3.3
3.2.1.2	Indications during Remote Control .....	3.3
3.2.1.3	Return to Manual Operation.....	3.3
3.2.2	Remote Control via RS-232-Interface.....	3.4
3.2.2.1	Setting the Transmission Parameters .....	3.4
3.2.2.2	Indications during Remote Control .....	3.4
3.2.2.3	Return to Manual Operating.....	3.4
<b>3.3</b>	<b>Messages .....</b>	<b>3.4</b>
3.3.1	Interface Message .....	3.4
3.3.2	Device Messages (Commands and Device Responses) .....	3.5
<b>3.4</b>	<b>Structure and Syntax of the Device Messages.....</b>	<b>3.5</b>
3.4.1	SCPI Introduction.....	3.5
3.4.2	Structure of a Command .....	3.6
3.4.3	Structure of a Command Line.....	3.8
3.4.4	Responses to Queries .....	3.8
3.4.5	Parameter.....	3.9
3.4.6	Overview of Syntax Elements.....	3.11
<b>3.5</b>	<b>Description of Commands.....</b>	<b>3.12</b>
3.5.1	Notation.....	3.12
3.5.2	Common Commands.....	3.14
3.5.3	ABORt System.....	3.17
3.5.4	ARB System.....	3.18
3.5.4.1	ARB Waveform Format .....	3.23
3.5.4.2	Creating a Waveform „Manually“ .....	3.25
3.5.4.3	Converting a Waveform with the Application Software AMIQ-K2.....	3.29
3.5.4.4	AMIQ Compatible Commands for Transmission and Administration of Waveforms .....	3.29
3.5.5	BERT System .....	3.30
3.5.6	BLER System.....	3.34
3.5.7	CALibration System .....	3.37
3.5.8	DIAGnostic System.....	3.40
3.5.9	DISPLAY System.....	3.43
3.5.10	FORMat System .....	3.44
3.5.11	MEMory System.....	3.45
3.5.12	OUTPut System.....	3.46
3.5.13	OUTPut2 System.....	3.48
3.5.14	SOURce System.....	3.49
3.5.14.1	SOURce:AM Subsystem.....	3.50
3.5.14.2	SOURce:CORRection Subsystem.....	3.51
3.5.14.3	SOURce:DECT Subsystem .....	3.53

3.5.14.4	SOURce:DIST Subsystem.....	3.61
3.5.14.5	SOURce:DM Subsystem .....	3.65
	Vector Modulation .....	3.65
	Digital Modulation .....	3.67
3.5.14.6	SOURce:FM Subsystem.....	3.78
3.5.14.7	SOURce:FREQuency Subsystem .....	3.80
3.5.14.8	SOURce:FSIM-Subsystem .....	3.82
3.5.14.9	SOURce:GPS Subsystem .....	3.93
3.5.14.10	SOURce:GSM Subsystem (Digital Standard GSM/EDGE) .....	3.96
3.5.14.11	SOURce:IS95 Subsystem (Digital Standard IS-95 CDMA) .....	3.102
3.5.14.12	SOURce:LIST Subsystem .....	3.110
3.5.14.13	SOURce:MARKer Subsystem .....	3.112
3.5.14.14	SOURce:MODulation Subsystem .....	3.114
3.5.14.15	SOURce:NADC Subsystem.....	3.115
3.5.14.16	SOURce:NOISe Subsystem .....	3.123
3.5.14.17	SOURce:PDC Subsystem .....	3.124
3.5.14.18	SOURce:PHASe Subsystem .....	3.133
3.5.14.19	SOURce:PHS Subsystem.....	3.134
3.5.14.20	SOURce:PM Subsystem.....	3.142
3.5.14.21	SOURce:POWer Subsystem.....	3.144
3.5.14.22	SOURce:PULM Subsystem .....	3.147
3.5.14.23	SOURce:ROSCillator Subsystem .....	3.148
3.5.14.24	SOURce:SWEep Subsystem.....	3.149
3.5.14.25	SOURce:WCDMa Subsystem (NTT DoCoMo/ARIB 0.0) .....	3.152
3.5.14.26	SOURce:W3GPP-Subsystem .....	3.159
3.5.14.27	SOURce:W3GPP:ENHanced/OCNS/ADDitional Subsystems .....	3.180
3.5.15	SOURce2 System.....	3.194
3.5.15.1	SOURce2:FREQuency Subsystem .....	3.194
3.5.15.2	SOURce2:MARKer Subsystem .....	3.196
3.5.15.3	SOURce2:SWEep Subsystem.....	3.197
3.5.16	STATus System.....	3.199
3.5.17	SYSTem System .....	3.201
3.5.18	TEST System.....	3.207
3.5.19	TRIGger System .....	3.210
3.5.20	UNIT System .....	3.215
<b>3.6</b>	<b>Instrument Model and Command Processing .....</b>	<b>3.215</b>
3.6.1	Input Unit.....	3.215
3.6.2	Command Recognition .....	3.216
3.6.3	Data Set and Instrument Hardware .....	3.216
3.6.4	Status Reporting System .....	3.216
3.6.5	Output Unit.....	3.217
3.6.6	Command Sequence and Command Synchronization.....	3.217
<b>3.7</b>	<b>Status Reporting System.....</b>	<b>3.218</b>
3.7.1	Structure of an SCPI Status Register .....	3.218
3.7.2	Overview of the Status Registers .....	3.220
3.7.3	Description of the Status Registers .....	3.221
3.7.3.1	Status Byte (STB) and Service Request Enable Register (SRE) .....	3.221
3.7.3.2	IST Flag and Parallel Poll Enable Register (PPE) .....	3.222
3.7.3.3	Event Status Register (ESR) and Event Status Enable Register (ESE).....	3.222
3.7.3.4	STATus:OPERation Register .....	3.223
3.7.3.5	STATus:QUESTionable Register.....	3.224



---

3.7.4	Application of the Status Reporting Systems.....	3.225
3.7.4.1	Service Request, Making Use of the Hierarchy Structure .....	3.225
3.7.4.2	Serial Poll.....	3.225
3.7.4.3	Parallel Poll .....	3.226
3.7.4.4	Query by Means of Commands .....	3.226
3.7.4.5	Error Queue Query .....	3.226
3.7.5	Resetting Values of the Status Reporting Systems .....	3.227
<b>3.8</b>	<b>Fast Restore Mode .....</b>	<b>3.228</b>
3.8.1	Commands .....	3.228
3.8.2	Call-Up and Termination of Operating Mode .....	3.229
3.8.3	Effects on Device Settings.....	3.229
3.8.4	Alternative Use with Other IEC/IEEE-Bus Commands .....	3.230
3.8.5	Synchronization Signal.....	3.230
<b>4</b>	<b>Maintenance and Troubleshooting .....</b>	<b>4.2</b>
<b>4.1</b>	<b>Maintenance.....</b>	<b>4.2</b>
4.1.1	Cleaning the Outside.....	4.2
4.1.2	Storage.....	4.2
<b>4.2</b>	<b>Functional Test .....</b>	<b>4.2</b>

<b>5</b>	<b>Checking the Rated Characteristics .....</b>	<b>5.2</b>
<b>5.1</b>	<b>Test Equipment and Test Assemblies.....</b>	<b>5.2</b>
5.1.1	Measuring Equipment and Accessories.....	5.2
5.1.2	Test Assemblies.....	5.3
5.1.2.1	Standard Test Assembly for Analog Modulations.....	5.3
5.1.2.2	Test Assembly for Analog Modulations with Audio Analyzer.....	5.5
5.1.2.3	Test Assembly for Broadband FM.....	5.5
5.1.2.4	Test Assembly for Pulse Modulation.....	5.6
5.1.2.5	Test Assembly for Vector Modulation.....	5.6
5.1.2.6	Test Assembly for SSB Phase Noise.....	5.7
5.1.2.7	Test Assembly for Output Impedance (VSWR).....	5.7
5.1.2.8	Test Assembly with Spectrum Analyzer for Fading Simulation.....	5.8
5.1.2.9	Test Assembly with Sampling Oscilloscope for Fading Simulation.....	5.8
5.1.2.10	Test Assembly for Amplitude Settling.....	5.8
<b>5.2</b>	<b>Preparation, Recommended Test Frequencies and Levels .....</b>	<b>5.9</b>
<b>5.3</b>	<b>Test Procedures .....</b>	<b>5.10</b>
5.3.1	Display and Keyboard.....	5.10
5.3.2	Frequency.....	5.10
5.3.2.1	Frequency Setting.....	5.10
5.3.1.2	Settling Time.....	5.12
5.3.1.3	Setting Time LIST MODE.....	5.14
5.3.3	Reference Frequency.....	5.15
5.3.1.1	Output of Internal Reference.....	5.15
5.3.1.2	Input for External Reference.....	5.15
5.3.4	Level.....	5.15
5.3.4.1	Level Uncertainty.....	5.15
5.31.1.2	Output Impedance.....	5.17
5.3.1.3	Settling Time.....	5.18
5.31.1.4	Non-Interrupting Level Setting (ATTENUATOR MODE FIXED).....	5.20
5.3.1.5	Overvoltage Protection (if provided).....	5.21
5.3.5	Spectral Purity.....	5.21
5.3.5.1	Harmonics.....	5.21
5.3.1.2	Subharmonics.....	5.22
5.3.1.3	Nonharmonics.....	5.22
5.3.1.4	Broadband Noise.....	5.25
5.3.1.5	SSB Phase Noise.....	5.26
5.3.1.6	Residual FM.....	5.27
5.3.1.7	Residual AM.....	5.27
5.3.6	Sweep.....	5.27
5.3.7	Internal Modulation Generator.....	5.28
5.3.8	Vector Modulation.....	5.29
5.3.8.1	Input Impedance (VSWR).....	5.29
5.3.1.2	Maximum Level.....	5.29
5.3.1.3	Error Vector.....	5.30
5.3.1.4	Modulation Frequency Response.....	5.30
5.3.1.5	Residual Carrier and Leakage.....	5.31
5.3.1.6	I/Q Imbalance.....	5.32
5.3.1.7	Level Control POW RAMP.....	5.33
5.3.9	Amplitude Modulation.....	5.35
5.3.9.1	Modulation Depth Setting.....	5.35

5.3.9.2	AM Distortion .....	5.35
5.3.9.3	AM Frequency Response .....	5.35
5.3.9.4	Residual PhiM with AM .....	5.36
5.3.9.5	Level Monitoring at Input EXT1.....	5.36
5.3.10	Broadband Amplitude Modulation .....	5.37
5.3.11	Pulse Modulation.....	5.37
5.3.11.1	ON/OFF Ratio.....	5.37
5.3.11.2	Dynamic Characteristics .....	5.38
5.3.12	Frequency Modulation (Option SM-B5).....	5.38
5.3.12.1	FM Deviation Setting.....	5.38
5.3.12.2	FM Distortion.....	5.39
5.3.12.3	FM Frequency Response.....	5.40
5.3.12.4	FM Preemphasis (optional).....	5.41
5.3.12.5	Residual AM with FM .....	5.41
5.3.12.6	Carrier Frequency Error with FM .....	5.41
5.3.12.7	Level Monitoring at Input EXT2.....	5.42
5.3.13	Phase Modulation (Option SM-B5).....	5.42
5.3.13.1	Deviation Setting.....	5.42
5.3.13.2	PhiM Distortion.....	5.42
5.3.13.3	PhiM Frequency Response.....	5.43
5.3.14	Digital Modulation (Option SMIQB20) .....	5.43
5.3.14.1	Level Error and Residual Carrier with Digital Modulation .....	5.43
5.3.14.2	Analog Outputs with Digital Modulation .....	5.44
5.3.14.3	Modulation Depth with ASK .....	5.44
5.3.14.4	Deviation Error with FSK.....	5.44
5.3.14.5	Deviation Error with GFSK.....	5.45
5.3.14.6	Phase Error with GMSK.....	5.45
5.3.14.7	Error Vector with PSK .....	5.45
5.3.14.8	Error Vector with QAM .....	5.45
5.3.15	Data Generator and Memory Extension (Option SMIQB11/SMIQB12) .....	5.46
5.3.15.1	Battery Test.....	5.46
5.3.15.2	Function Test .....	5.46
5.3.15.3	Interface SERDATA .....	5.48
5.3.15.4	Memory Test (including SMIQB12).....	5.49
5.3.16	Digital Standards (Options) .....	5.51
5.3.16.1	Adjacent-Channel Power Measurement with Higher Resolution .....	5.51
5.1.16.1.1	Broadband Systems .....	5.51
5.1.16.1.2	Narrowband Systems .....	5.52
5.3.16.2	GSM/EDGE.....	5.52
5.3.16.3	DECT .....	5.53
5.3.16.4	NADC.....	5.55
5.3.16.5	TETRA .....	5.55
5.3.16.6	PDC .....	5.56
5.3.16.7	PHS.....	5.57
5.3.17	IS-95 CDMA (Option SMIQB42).....	5.58
5.3.18	W-CDMA - NTT DoCoMo/ARIB 0.0 (Option SMIQB43) .....	5.59
5.3.19	3GPP W-CDMA for SMIQ with firmware version up to 5.20 (Options SMIQB20 and SMIQB45) .....	5.60
5.1.19.1	3GPP W-CDMA with 1 Code Channel.....	5.60
5.1.19.2	3GPP W-CDMA with 8 Code Channels.....	5.62
5.3.20	3GPP W-CDMA for SMIQ with Firmware Versions 5.30 or Higher (Options SMIQB20 and SMIQB45) .....	5.64
5.3.20.1	3GPP W-CDMA with 1 Code Channel.....	5.64

5.3.20.2	3GPP W-CDMA with 8 Code Channels .....	5.67
5.3.20.3	3GPP W-CDMA Test Model 1, 64 DPCH .....	5.68
5.3.21	3GPP W-CDMA Enhanced Channels (SMIQB48) .....	5.69
5.3.21.1	External Power Control .....	5.69
5.3.22	Bit Error Rate Test (Option SMIQB21) .....	5.70
5.3.23	Fading Simulation (Option SMIQB14/SMIQB15) .....	5.72
5.3.23.1	Frequency Response .....	5.72
5.3.23.2	Additional Modulation Frequency Response .....	5.73
5.3.23.3	Carrier Leakage for Fading .....	5.73
5.3.23.4	Path Attenuation .....	5.73
5.3.23.5	Path Delay (optional) .....	5.76
5.3.23.6	Doppler Shift (optional) .....	5.77
5.3.24	Noise Generation and Distortion Simulation (Option SMIQB17) .....	5.78
5.3.24.1	RF Bandwidth .....	5.78
5.3.24.2	Additional Modulation Frequency Response .....	5.80
5.3.24.3	Residual Carrier .....	5.80
5.3.24.4	Frequency Response through to I-FADED, Q-FADED Outputs .....	5.81
5.3.24.5	Signal/Noise Ratio (Carrier/Noise Ratio) .....	5.82
5.3.24.6	Signal/Noise Ratio (Carrier/Noise Ratio) Worldspace .....	5.84
5.3.24.7	Error Vector .....	5.84
5.3.24.8	Noise Frequency Response .....	5.85
5.3.25	Arbitrary Waveform Generator (ARB, Option SMIQB60) .....	5.86
5.3.25.1	Frequency Response .....	5.86
5.3.25.2	DC Voltage Offset .....	5.87
5.3.25.3	Spurious-Free Dynamic Range (SFDR) .....	5.87
5.3.25.4	Level Difference of Channels .....	5.89
5.3.26	Additional Measurements for SMIQ03S .....	5.90
<b>5.4</b>	<b>Performance Test Report .....</b>	<b>5.92</b>
<b>A</b>	<b>Annex A .....</b>	<b>A.2</b>
<b>A.1</b>	<b>IEC/IEEE Bus Interface .....</b>	<b>A.2</b>
A.1.1	Characteristics of the Interface .....	A.2
A.1.2	Bus Lines .....	A.2
A.1.3	Interface Functions .....	A.3
A.1.4	Interface Messages .....	A.4
<b>A.2</b>	<b>RS-232-C Interface .....</b>	<b>A.5</b>
A.2.1	Interface characteristics .....	A.5
A.2.2	Signal lines .....	A.5
A.2.2.1	Transmission parameters .....	A.6
A.2.3	Interface functions .....	A.6
A.2.3.1	Handshake .....	A.7
<b>A.3</b>	<b>Asynchronous Interface SERDATA .....</b>	<b>A.8</b>
<b>B</b>	<b>Annex B .....</b>	<b>B.2</b>
<b>B.1</b>	<b>List of Error Messages .....</b>	<b>B.2</b>
B.1.1	SCPI-Specific Error Messages .....	B.2
B.1.2	SMIQ-Specific Error Messages .....	B.6

---

<b>C Annex C</b> .....	<b>C.1</b>
<b>C.1 List of Commands (with SCPI Conformity Information)</b> .....	<b>C.1</b>
<b>D Annex D</b> .....	<b>D.1</b>
<b>D.1 Programming Examples</b> .....	<b>D.1</b>
1. Including IEC-Bus Library for QuickBasic .....	D.1
2. Initialization and Default Status .....	D.1
2.1. Initiate Controller .....	D.1
2.2. Initiate Instrument.....	D.1
3. Transmission of Instrument Setting Commands.....	D.2
4. Switchover to Manual Control .....	D.2
5. Reading out Instrument Settings .....	D.2
6. List Management.....	D.3
7. Command synchronization.....	D.3
8. Service Request.....	D.4

**10 Index**

## Tables

Table 2-1	Input sockets for the different types of modulation.....	2.55
Table 2-2	Status messages in the case of a deviation from the rated value at the external modulation inputs EXT1 and EXT2.....	2.56
Table 2-3	Parameter setting ranges.....	2.69
Table 2-4	Phase shifts for $\pi/4$ DQPSK without coding.....	2.87
Table 2-5	Phase shifts for $\pi/4$ DQPSK with coding NADC, PDC, PHS, TETRA or APCO25.....	2.87
Table 2-6	Phase shifts for $\pi/4$ DQPSK with coding TFTS.....	2.87
Table 2-7	Frequency deviations for FSK methods.....	2.88
Table 2-8	Possible combination of modulation method and coding.....	2.88
Table 2-9	Coding algorithms.....	2.89
Table 2-10	Examples of settings conflicts	2.90
Table 2-11	PRBS generators of modulation coder.....	2.93
Table 2-12	Logic function of signals BURST GATE and LEVEL ATT.....	2.98
Table 2-13	PRBS generators for PHS	2.116
Table 2-14	CDMA: channel numbers and their frequencies.....	2.131
Table 2-15	Preferred CDMA-frequency channels according to J-STD-008.....	2.131
Table 2-16	PN generators for IS-95 reverse link.....	2.134
Table 2-17	PN generators for W-CDMA	2.152
Table 2-18	Parameters of W-CDMA system	2.169
Table 2-19	Generator polynomials of uplink long scrambling code generators.....	2.171
Table 2-20	Generator polynomials of uplink short scrambling code generators.....	2.172
Table 2-21	Mapping of the quaternary output sequence into the binary IQ level.....	2.172
Table 2-22	Hierarchical structure of 3GPP W-CDMA frames.....	2.174
Table 2-23	Structure of the DPDCH channel table depending on the overall symbol rate.....	2.206
Table 2-24	Change of crest factor in the case of clipping.....	2.213
Table 2-25	Default values for base station parameters.....	2.216
Table 2-26	Default values for mobile station parameters.....	2.217
Table 2-27	References to measurement channels.....	2.241
Table 2-28	OCNS channels	2.256
Table 2-29	PRBS generators for NADC	2.261
Table 2-30	PRBS generators for PDC	2.278
Table 2-31	PRBS generators for GSM	2.300
Table 2-32	PRBS generators for DECT	2.317
Table 2-33	LIST mode; Example of a list	2.393
Table 2-35	MEMORY SEQUENCE; Example of a list.....	2.398
Table 3-1	Common Commands.....	3.14
Table 3-2	List of possible responses to *OPT?.....	3.15
Table 3-3	Synchronization with *OPC, *OPC? and *WAI.....	3.213
Table 3-4	Meaning of the bits used in the status byte.....	3.217
Table 3-5	Meaning of the bits used in the event status register.....	3.218
Table 3-6	Meaning of the bits used in the STATus:OPERation register.....	3.219
Table 3-7	Meaning of the bits used in the STATus:QUEStionable register.....	3.220
Table 3-8	Resetting instrument functions.....	3.223
Table 5-1	Measuring equipment and accessories.....	5.1
Table 5-2	Range limits, main test frequencies with/without vector modulation.....	5.7
Table A-1	Interface function.....	A.2
Table A-2	Universal Commands.....	A.3
Table A-3	Addressed Commands.....	A.3
Table A-4	Interface functions (RS-232-C).....	A.5

Figures

Fig. 1-1	SMIQ, view from the top .....	1.5
Fig. 1-2	Module FSIM.....	1.9
Fig. 1-3	Module NDSIM.....	1.13
Fig. 1-4	Module MCOD .....	1.14
Fig. 2-1	Front panel view.....	2.2
Fig. 2-2	Rear panel view .....	2.12
Fig. 2-3	Design of the display.....	2.22
Fig. 2-4	MODULATION-AM menu .....	2.23
Fig. 2-5	Display after AM setting .....	2.29
Fig. 2-6	Display after pattern setting .....	2.31
Fig. 2-7	OPERATION page of the MEM SEQ menu.....	2.32
Fig. 2-8	SELECT-LIST-selection window.....	2.33
Fig. 2-9	DELETE-LIST selection window .....	2.34
Fig. 2-10	Edit function EDIT/VIEW .....	2.35
Fig. 2-11	Block function FILL: Input window .....	2.36
Fig. 2-12	Edit function INSERT: Input window .....	2.38
Fig. 2-13	Edit function DELETE: Input window .....	2.39
Fig. 2-14	Starting point of the pattern setting .....	2.40
Fig. 2-15, a to c	Pattern setting - Edition of a list .....	2.42
Fig. 2-16	Menu FREQUENCY (preset setting) .....	2.45
Fig. 2-17	Example of a circuit with frequency offset .....	2.46
Fig. 2-18	Menu LEVEL (preset setting) POWER RESOLUTION is set to 0.01 dB.....	2.47
Fig. 2-19	Example of a circuit with level offset.....	2.49
Fig. 2-20	Menu LEVEL - ALC (preset setting) .....	2.51
Fig. 2-21	Menu LEVEL - UCOR - OPERATION side.....	2.52
Fig. 2-22	Menu UCOR - LEVEL-EDIT side.....	2.53
Fig. 2-23	Menu LEVEL-EMF .....	2.53
Fig. 2-24	Example: Status message "EXT1-LOW" in case of voltage at EXT1 too low .....	2.56
Fig. 2-25	Example: Settings of the LF generator in the AM menu.....	2.57
Fig. 2-26	Menu ANALOG MOD-AM (preset setting).....	2.59
Fig. 2-27	Menu ANALOG MOD - BB-AM (preset setting).....	2.60
Fig. 2-28	Menu ANALOG MOD-FM (preset setting), fitted with option SM-B5, FM/PM-modulator .....	2.61
Fig. 2-29	Dependency of the FM maximal deviation on the RF frequency set .....	2.62
Fig. 2-30	Menu ANALOG MOD - PM (preset setting), fitted with option SM-B5, FM/PM- modulator .....	2.63
Fig. 2-31	Dependency of the PM maximal deviation on the RF frequency set .....	2.64
Fig. 2-32	Menu MODULATION-PULSE (preset setting), fitted with option SM-B3, pulse modulator, and option SM-B4, pulse generator .....	2.65
Fig. 2-33	Example: vector modulation .....	2.66
Fig. 2-34	VECTOR MOD menu (preset settings), equipped with option SMIQB47 and IQMOD var. 8 or higher .....	2.67
Fig. 2-35	Effect of I/Q impairment.....	2.69
Fig. 2-36	Fading simulator in the SMIQ .....	2.70
Fig. 2-37	Two-channel fading .....	2.71
Fig. 2-38	Menu FADING SIM with submenus.....	2.72
Fig. 2-39	Menu STANDARD FADING (two Fading Simulators installed) .....	2.73
Fig. 2-40	Doppler Frequency shift with moving receiver .....	2.76
Fig. 2-41	Menu FINE DELAY .....	2.78
Fig. 2-42	Two paths with menu MOVING DELAY .....	2.80
Fig. 2-43	Menu MOVING DELAY.....	2.80
Fig. 2-44	Example of hop sequence with BIRTH-DEATH fading.....	2.82
Fig. 2-45	Menu BIRTH-DEATH.....	2.82

Fig. 2-46	Pulse on Oscilloscope .....	2.84
Fig. 2-47	Modulation coder in SMIQ .....	2.85
Fig. 2-48	Digital input signals of modulation coder .....	2.85
Fig. 2-49	Functional blocks Coding and Mapping.....	2.86
Fig. 2-50	Constellation diagrams of BPSK, QPSK, 8PSK and 16QAM .....	2.86
Fig. 2-51	DATA LIST for modulation data.....	2.91
Fig. 2-52	CONTROL LIST for control signals .....	2.92
Fig. 2-53	9-bit PRBS generator.....	2.93
Fig. 2-54	External serial data and bit clock Data change should take place only on the negative clock edge. ....	2.95
Fig. 2-55	External serial data and symbol clock, 3 bit/symbol SYMBOL CLOCK = High marks the LSB. A status change of DATA and SYMBOL CLOCK should be performed synchronously.....	2.95
Fig. 2-56	External serial data, internal clock signals.....	2.95
Fig. 2-57	External parallel data and symbol clock Data change should take place only on the negative clock edge. ....	2.96
Fig. 2-58	External parallel data and symbol clock SYMBOL CLOCK = High marks the LSB. A status change of DATA and SYMBOL CLOCK should be performed synchronously.....	2.96
Fig. 2-59	Envelope control in SMIQ with modulation coder .....	2.98
Fig. 2-60	Signal waveforms during envelope control .....	2.99
Fig. 2-61	DIGITAL MOD menu, SMIQ equipped with option Modulation Coder SMIQB20 and option Data Generator SMIQB11 .....	2.100
Fig. 2-62	DIGITAL MOD-SOURCE menu, SMIQ equipped with option Modulation Coder SMIQB20 and option Data Generator SMIQB11 .....	2.100
Fig. 2-63	DIGITAL MOD - MODULATION... menu, SMIQ equipped with option Modulation Coder SMIQB20 and option Data Generator SMIQB11 .....	2.103
Fig. 2-64	DIGITAL MOD -FILTER... menu, SMIQ equipped with option Modulation Coder SMIQB20 and option Data Generator SMIQB11 .....	2.105
Fig. 2-65	DIGITAL MOD - TRIGGER menu, SMIQ equipped with option Modulation Coder SMIQB20 and option Data Generator SMIQB11 .....	2.108
Fig. 2-66	DIGITAL MOD - CLOCK, SMIQ equipped with option Modulation Coder SMIQB20 and option Data Generator SMIQB11 .....	2.109
Fig. 2-67	DIGITAL MOD - POWER RAMP CONTROL menu, SMIQ equipped with option Modulation Coder SMIQB20 and option Data Generator SMIQB11 .....	2.111
Fig. 2-68	DIGITAL MOD - EXT INPUTS menu, SMIQ equipped with option Modulation Coder SMIQB20 and option Data Generator SMIQB11 .....	2.112
Fig. 2-69	Menu DIGITAL STD - PHS, SMIQ equipped with Modulation Coder SMIQB20 and Data Generator SMIQB11 .....	2.118
Fig. 2-70	Menu DIGITAL STD - PHS - MODULATION..., SMIQ equipped with Modulation Coder SMIQB20 and Data Generator SMIQB11 .....	2.118
Fig. 2-71	Menu DIGITAL STD - PHS_TRIGGER..., SMIQ equipped with Modulation Coder SMIQB20 and Data Generator SMIQB11 .....	2.120
Fig. 2-72	Menu DIGITAL STD - PHS - CLOCK..., SMIQ equipped with Modulation Coder SMIQB20 and Data Generator SMIQB11 .....	2.122
Fig. 2-73	Menu DIGITAL STD - PHS - POWER RAMP CONTROL... , SMIQ equipped with Modulation Coder SMIQB20 and Data Generator SMIQB11 .....	2.123
Fig. 2-74	Menu DIGITAL STD - PHS - SAVE/RCL FRAME, SMIQ equipped with Modulation Coder SMIQB20 and Data Generator SMIQB11 .....	2.124
Fig. 2-75	Menu DIGITAL STD - PHS - SELECT SLOT, SMIQ equipped with Modulation Coder SMIQB20 and Data Generator SMIQB11 .....	2.125
Fig. 2-76	Forward link signal generation.....	2.129
Fig. 2-77	Reverse link signal generation without channel coding .....	2.130
Fig. 2-78	Traffic channel 9600 in "Reverse Link Coded" mode .....	2.130
Fig. 2-79	Frame structure of traffic channel 9600 in "Reverse Link Coded" mode.....	2.131
Fig. 2-80	CDMA sync signals.....	2.132



Fig. 2-81	Menu DIGITAL STD - IS-95 - MODE - FWD_LINK_18, equipped with options modulation coder SMIQB20, data generator SMIQB11 and SMIQB42 .....	2.135
Fig. 2-82	Menu DIGITAL STD - IS-95 - MODULATION..., equipped with options modulation coder SMIQB20, data generator SMIQB11 and SMIQB42 .....	2.137
Fig. 2-83	Menu DIGITAL STD - IS-95 - TRIGGER..., equipped with options modulation coder SMIQB20, data generator SMIQB11 and SMIQB42.....	2.139
Fig. 2-84	Menu DIGITAL STD - IS-95 - CLOCK..., equipped with options modulation coder SMIQB20, data generator SMIQB11 and SMIQB42.....	2.141
Fig. 2-85	Menu DIGITAL STD - IS-95 - SAVE/RCL MAPPING..., equipped with options modulation coder SMIQB20, data generator SMIQB11 and SMIQB42 .....	2.143
Fig. 2-86	Menu DIGITAL STD - IS-95 - MODE - REV_LINK .....	2.145
Fig. 2-87	Menu DIGITAL STD - IS-95 - MODE - REV_LINK_CODED .....	2.147
Fig. 2-88	Downlink DPCH signal generation for a code channel .....	2.149
Fig. 2-89	Uplink signal generation with IQ multiplex and several code channels .....	2.150
Fig. 2-90	Menu DIGITAL STD - WCDMA - MODE - 8CHAN, LINK DIRECTION/MULTIPLEX - DOWN, equipped with options modulation coder SMIQB20, data generator SMIQB11 and SMIQB43.....	2.153
Fig. 2-91	Menu DIGITAL STD - WCDMA - MODULATION..., equipped with options modulation coder SMIQB20, data generator SMIQB11 and SMIQB43 .....	2.156
Fig. 2-92	Menu DIGITAL STD - WCDMA - TRIGGER..., equipped with options modulation coder SMIQB20, data generator SMIQB11 and SMIQB43 .....	2.158
Fig. 2-93	Menu DIGITAL STD - WCDMA - MULTICODE..., equipped with options modulation coder SMIQB20, data generator SMIQB11 and SMIQB43 .....	2.160
Fig. 2-94	Menu DIGITAL STD - WCDMA - SPREAD CODE; equipped with options modulation coder SMIQB20, data generator SMIQB11 and SMIQB43 .....	2.161
Fig. 2-95	Menu DIGITAL STD - WCDMA - DATA; equipped with options modulation coder SMIQB20, data generator SMIQB11 and SMIQB43.....	2.162
Fig. 2-96	Menu DIGITAL STD - WCDMA - MODE - 8CHAN, -LINK DIRECTION/MULTIPLEX - UP_IQ_MULT, equipped with options modulation coder SMIQB20, data generator SMIQB11 and SMIQB43.....	2.164
Fig. 2-98	Structure of the downlink scrambling code generator .....	2.171
Fig. 2-99	Structure of the uplink short scrambling code generator .....	2.172
Fig. 2-100	Constellation diagram of a channel with 0 dB power .....	2.173
Fig. 2-101	Constellation diagram of a channel with -6 dB power .....	2.175
Fig. 2-102	Constellation diagram of a 3GPP W-CDMA signal with two DPCH channels .....	2.176
Fig. 2-103	Overview of DIGITAL STD – 3GPP WCDMA/3GPP menu structure .....	2.177
Fig. 2-104	DIGITAL STD - WCDMA/3GPP - Downlink menu.....	2.178
Fig. 2-105	DIGITAL STD - WCDMA/3GPP - FILTER... menu.....	2.180
Fig. 2-106	DIGITAL STD - WCDMA/3GPP - Downlink - COPY BS(MS) menu.....	2.182
Fig. 2-107	DIGITAL STD – WCDMA/3GPP – TRIGGER... menu .....	2.183
Fig. 2-108	DIGITAL STD – WCDMA/3GPP – SELECT BS(MS) menu .....	2.185
Fig. 2-109	DIGITAL STD - WCDMA/3GPP - PARA. PREDEF. menu (only downlink) .....	2.186
Fig. 2-110	DIGITAL STD – WCDMA/3GPP – CCDF menu with a trace .....	2.187
Fig. 2-111	Reading off the crest factor from LEVEL displays .....	2.187
Fig. 2-112	DIGITAL STD – WCDMA/3GPP – CCDF menu with three traces .....	2.187
Fig. 2-113	DIGITAL STD - WCDMA/3GPP – CONSTELLATION menu .....	2.188
Fig. 2-114	DIGITAL STD - WCDMA/3GPP - BS CONFIGURATION menu .....	2.189
Fig. 2-115	Dynamic change of channel power (continuous).....	2.191
Fig. 2-116	DIGITAL STD – WCDMA/3GPP – BS CONFIGURATION / channel table menu ..	2.192
Fig. 2-117	DIGITAL STD – WCDMA/3GPP – MS CONFIGURATION menu.....	2.194
Fig. 2-118	DIGITAL STD – WCDMA/3GPP – MS CONFIGURATION: PRACH only Mode menu.....	2.197
Fig. 2-119	DIGITAL STD – WCDMA/3GPP – MS CONFIGURATION: PCPCH only Mode menu.....	2.198

Fig. 2-120	DIGITAL STD – WCDMA/3GPP – MS CONFIGURATION: DPCCH + DPDCH Mode menu.....	2.200
Fig. 2-121	Dynamic change of channel power (continuous).....	2.201
Fig. 2-122	DIGITAL STD – WCDMA/3GPP – BS CONFIGURATION / MULTI CHANNEL EDIT menu.....	2.203
Fig. 2-123	DIGITAL STD – WCDMA/3GPP – BS CONFIGURATION /CHANNEL GRAPH menu .....	2.205
Fig. 2-124	Code tree of channelization codes.....	2.206
Fig. 2-125	WCDMA/3GPP – BS CONFIGURATION / CODE DOMAIN menu (without conflict).....	2.206
Fig. 2-126	WCDMA/3GPP – BS CONFIGURATION / CODE DOMAIN menu (with conflict) ..	2.207
Fig. 2-127	WCDMA/3GPP – BS CONFIGURATION / CODE DOMAIN CONFLICT menu.....	2.207
Fig. 2-128	WCDMA/3GPP – BS CONFIGURATION / CODE DOMAIN menu (after conflict resolution) .....	2.208
Fig. 2-129	Constellation at clipping level 100% (not clipped).....	2.209
Fig. 2-130	Constellation at clipping level 50% .....	2.209
Fig. 2-131	Signal consisting of P-CCPCH, P-SCH and S-SCH in time domain.....	2.214
Fig. 2-132	Signal consisting of P-CCPCH, P-SCH and S-SCH in time domain (zoomed) .....	2.214
Fig. 2-133	Constellation diagram of a signal consisting of P-CCPCH, P-SCH and S-SCH.....	2.215
Fig. 2-134	Envelope of P-CCPCH.....	2.215
Fig. 2-135	Envelope of P-SCH or S-SCH .....	2.216
Fig. 2-136	Envelope of AICH (Subchannel) .....	2.216
Fig. 2-137	Envelope of AICH (four subchannels) .....	2.216
Fig. 2-138	Envelope of DL-DPCCH .....	2.216
Fig. 2-139	Envelope of DPCH 60 ksps without TFCI.....	2.216
Fig. 2-140	Constellation of a DPDCH/DPCCH channel.....	2.217
Fig. 2-141	Constellation of an uplink signal consisting of a DPDCH and a DPCCH.....	2.217
Fig. 2-142	Constellation of a PRACH.....	2.218
Fig. 2-143	Envelope of a PRACH .....	2.218
Fig. 2-144	Envelope of a PCPCH .....	2.218
Fig. 2-145	Magnitude spectrum of a 3GPP W-CDMA signal.....	2.219
Fig. 2-146	Magnitude spectrum (section) of a 3GPP W-CDMA signal with several channels .....	2.219
Fig. 2-147	Constellation of a signal with two DPCHs (uncorrelated data) .....	2.220
Fig. 2-148	Signal with two DPCHs (same data) in time domain .....	2.220
Fig. 2-149	Constellation of a signal with two DPCHs (uncorrelated data) .....	2.221
Fig. 2-150	Constellation with 16 uncorrelated channels (16 time slots).....	2.221
Fig. 2-151	Constellation with 16 uncorrelated channels (1 time slot) .....	2.222
Fig. 2-152	Constellation diagram of 16 DPCHs with same data.....	2.222
Fig. 2-153	Constellation diagram of 16 DPCHs with timing offset .....	2.223
Fig. 2-154	CDPA of a signal with compensated SCH.....	2.225
Fig. 2-155	Effect of SCH on CDP analysis (without compensation) .....	2.225
Fig. 2-156	Effect of different scrambling codes on the power distribution .....	2.226
Fig. 2-157	Cancellation possible in case of several channels with identical spreading sequences .....	2.226
Fig. 2-158	Incorrect detection at various symbol rates .....	2.227
Fig. 2-159	Non-restorable DPCH channel .....	2.227
Fig. 2-160	Complete setup for testing a W-CDMA receiver with SMIQ .....	2.230
Fig. 2-161	Menu DIGITAL STD – WCDMA/3GPP – Section Assistant/Enhanced Functions (downlink).....	2.231
Fig. 2-162	Menu DIGITAL STD – WCDMA/3GPP – Section Assistant/Enhanced Functions (uplink) .....	2.231
Fig. 2-163	Menu DIGITAL STD-WCDMA/3GPP-ENHANCED CHANNEL (downlink) .....	2.233
Fig. 2-164	Setup for testing Closed Loop Power Control.....	2.236
Fig. 2-165	Change of channel power of 4 enhanced channels.....	2.237
Fig. 2-166	DIGITAL STD - WCDMA/3GPP - ENHANCED CHANNELS STATE (uplink) menu.....	2.243
Fig. 2-167	Display of external power control mode.....	2.245

Fig. 2-168	DIGITAL STD - WCDMA/3GPP - OCNS CHANNELS menu .....	2.246
Fig. 2-169	DIGITAL STD - WCDMA/3GPP ADDITIONAL MS STATE menu.....	2.249
Fig. 2-170	Menu DIGITAL STD - NADC, SMIQ equipped with Modulation Coder SMIQB20 and Data Generator SMIQB11 .....	2.255
Fig. 2-171	Menu DIGITAL STD - NADC - MODULATION..., SMIQ equipped with Modulation Coder SMIQB20 and Data Generator SMIQB11 .....	2.255
Fig. 2-172	Menu DIGITAL STD - NADC_TRIGGER..., SMIQ equipped with Modulation Coder SMIQB20 and Data Generator SMIQB11 .....	2.257
Fig. 2-173	Menu DIGITAL STD - NADC - CLOCK..., SMIQ equipped with Modulation Coder SMIQB20 and Data Generator SMIQB11 .....	2.258
Fig. 2-174	Menu DIGITAL STD - NADC - POWER RAMP CONTROL... , SMIQ equipped with Modulation Coder SMIQB20 and Data Generator SMIQB11 .....	2.259
Fig. 2-175	Menu DIGITAL STD - NADC - SAVE/RCL FRAME, SMIQ equipped with Modulation Coder SMIQB20 and Data Generator SMIQB11 .....	2.261
Fig. 2-176	Menu DIGITAL STD - NADC - SELECT SLOT, LINK DIRECTION = DOWNLINK, SMIQ equipped with Modulation Coder SMIQB20 and Data Generator SMIQB11 .....	2.262
Fig. 2-177	Menu DIGITAL STD - NADC - SELECT SLOT, LINK DIRECTION = UPLINK, SMIQ equipped with Modulation Coder SMIQB20 and Data Generator SMIQB11 .....	2.265
Fig. 2-178	Menu DIGITAL STD - NADC - SELECT SLOT, SMIQ equipped with Modulation Coder SMIQB20 and Data Generator SMIQB11 .....	2.266
Fig. 2-179	Menu DIGITAL STD - PDC, SMIQ equipped with Modulation Coder SMIQB20 and Data Generator SMIQB11 .....	2.272
Fig. 2-180	Menu DIGITAL STD - PDC - MODULATION..., SMIQ equipped with Modulation Coder SMIQB20 and Data Generator SMIQB11 .....	2.272
Fig. 2-181	Menu DIGITAL STD - PDC_TRIGGER..., SMIQ equipped with Modulation Coder SMIQB20 and Data Generator SMIQB11 .....	2.274
Fig. 2-182	Menu DIGITAL STD - PDC - CLOCK..., SMIQ equipped with Modulation Coder SMIQB20 and Data Generator SMIQB11 .....	2.275
Fig. 2-183	Menu DIGITAL STD - PDC - POWER RAMP CONTROL... , SMIQ equipped with Modulation Coder SMIQB20 and Data Generator SMIQB11 .....	2.276
Fig. 2-184	Menu DIGITAL STD - PDC - SAVE/RCL FRAME, SMIQ equipped with Modulation Coder SMIQB20 and Data Generator SMIQB11 .....	2.278
Fig. 2-185	Menu DIGITAL STD - PDC - SELECT SLOT, LINK DIRECTION DOWNLINK, SMIQ equipped with Modulation Coder SMIQB20 and Data Generator SMIQB11 .....	2.279
Fig. 2-186	Menu DIGITAL STD - PDC - SELECT SLOT, LINK DIRECTION = DOWNLINK, SMIQ equipped with Modulation Coder SMIQB20 and Data Generator SMIQB11 .....	2.283
Fig. 2-187	Menu DIGITAL STD - PDC - SELECT SLOT, LINK DIRECTION = DOWNLINK, SMIQ equipped with Modulation Coder SMIQB20 and Data Generator SMIQB11 .....	2.285
Fig. 2-188	Menu DIGITAL STD - PDC - SELECT SLOT, LINK DIRECTION = UPLINK, SMIQ equipped with Modulation Coder SMIQB20 and Data Generator SMIQB11 .....	2.287
Fig. 2-189	Menu DIGITAL STD - GSM/EDGE, SMIQ equipped with Modulation Coder SMIQB20 and Data Generator SMIQB11 .....	2.294
Fig. 2-190	Menu DIGITAL STD - GSM/EDGE - MODULATION..., SMIQ equipped with Modulation Coder SMIQB20 and Data Generator SMIQB11 .....	2.294
Fig. 2-191	Menu DIGITAL STD - GSM/EDGE_TRIGGER..., SMIQ equipped with Modulation Coder SMIQB20 and Data Generator SMIQB11 .....	2.296
Fig. 2-192	Menu DIGITAL STD - GSM/EDGE - CLOCK..., SMIQ equipped with Modulation Coder SMIQB20 and Data Generator SMIQB11 .....	2.297
Fig. 2-193	Menu DIGITAL STD - GSM/EDGE - POWER RAMP CONTROL... , SMIQ equipped with Modulation Coder SMIQB20 and Data Generator SMIQB11 .....	2.298
Fig. 2-194	Menu DIGITAL STD - GSM/EDGE - SAVE/RCL FRAME, SMIQ equipped with Modulation Coder SMIQB20 and Data Generator SMIQB11 .....	2.299
Fig. 2-195	Menu DIGITAL STD - GSM/EDGE - SELECT SLOT - NORM, SMIQ equipped with Modulation Coder SMIQB20 and Data Generator SMIQB11 .....	2.300
Fig. 2-196	Menu DIGITAL STD - GSM/EDGE - SELECT SLOT - DUMMY, SMIQ equipped with Modulation Coder SMIQB20 and Data Generator SMIQB11 .....	2.302

Fig. 2-197	Menu DIGITAL STD - GSM/EDGE - SELECT SLOT – ALL_DATA, SMIQ equipped with Modulation Coder SMIQB20 and Data Generator SMIQB11 .....	2.304
Fig. 2-198	Menu DIGITAL STD - GSM/EDGE - SELECT SLOT – EDGE, SMIQ equipped with Modulation Coder SMIQB20 and Data Generator SMIQB11 .....	2.305
Fig. 2-199	Menu DIGITAL STD - DECT, SMIQ equipped with Modulation Coder SMIQB20 and Data Generator SMIQB11 .....	2.311
Fig. 2-200	Menu DIGITAL STD - DECT - MODULATION... ..	2.311
Fig. 2-201	Menu DIGITAL STD - DECT_TRIGGER..., SMIQ equipped with Modulation Coder SMIQB20 and Data Generator SMIQB11 .....	2.313
Fig. 2-202	Menu DIGITAL STD - DECT - CLOCK..., SMIQ equipped with Modulation Coder SMIQB20 and Data Generator SMIQB11 .....	2.315
Fig. 2-203	Menu DIGITAL STD - DECT - POWER RAMP CONTROL..., SMIQ equipped with Modulation Coder SMIQB20 and Data Generator SMIQB11 .....	2.316
Fig. 2-204	Menu DIGITAL STD - DECT - SAVE/RCL FRAME, SMIQ equipped with Modulation Coder SMIQB20 and Data Generator SMIQB11 .....	2.317
Fig. 2-205	Menu DIGITAL STD - DECT - SELECT SLOT, SMIQ equipped with Modulation Coder SMIQB20 and Data Generator SMIQB11 .....	2.319
Fig. 2-206	Signal flow of ARB generator .....	2.323
Fig. 2-207	Block diagram SMIQB60 .....	2.324
Fig. 2-208	Signal flow SMIQB60 .....	2.325
Fig. 2-209	Trigger signals SMIQB60 .....	2.326
Fig. 2-210	ARB MOD menu .....	2.327
Fig. 2-211	ARB MOD - TRIGGER... menu .....	2.329
Fig. 2-212	ARB MOD - SELECT WAVEFORM... menu .....	2.331
Fig. 2-213	ARB MOD - WAVEFORM INFO menu .....	2.331
Fig. 2-214	ARB MOD - DELETE WAVEFORM... menu .....	2.334
Fig. 2-215	ARB MOD - SET SMIQ ACCORDING TO WAVEFORM menu .....	2.334
Fig. 2-216	ARB MOD - CLOCK... menu .....	2.336
Fig. 2-217	ARB MOD - IQ OUTPUT... menu .....	2.337
Fig. 2-218	Vector modulation with an external AMIQ .....	2.338
Fig. 2-219	Menu AMIQ CTRL (presetting depends on AMIQ) .....	2.340
Fig. 2-220	Menu AMIQ CTRL -SETUP... ..	2.340
Fig. 2-221	Menu AMIQ CTRL -SAVE/RECALL SETTINGS... ..	2.342
Fig. 2-222	Menu AMIQ - SELECT WAVEFORM/EXECUTE BATCH.....	2.343
Fig. 2-223	Menu AMIQ CTRL -LEVEL.....	2.345
Fig. 2-224	Menu AMIQ CTRL - MARKER.....	2.347
Fig. 2-225	Menu AMIQ CTRL – BIT ERROR RATE TEST.....	2.348
Fig. 2-226	BER Measurement .....	2.350
Fig. 2-227	Operating menu for BER measurement .....	2.351
Fig. 2-228	PRBS polynomials .....	2.357
Fig. 2-229	Block diagram of noise generator and distortion simulator.....	2.360
Fig. 2-230	Noise generator and distortion simulator in SMIQ .....	2.360
Fig. 2-231	Menu NOISE/DIST (presetting) .....	2.361
Fig. 2-232	Menu NOISE/DIST - POLYNOMIAL.....	2.362
Fig. 2-233	AM/AM conversion.....	2.364
Fig. 2-234	AM/PM conversion.....	2.364
Fig. 2-235	Menu LF OUTPUT (preset setting).....	2.368
Fig. 2-236	Signal example sweep: MODE = AUTO, BLANK TIME = NORMAL .....	2.372
Fig. 2-237	Signal example sweep: MODE = SINGLE, BLANK TIME = LONG .....	2.372
Fig. 2-238	Menu SWEEP - FREQ.....	2.373
Fig. 2-239	Menu SWEEP - LEVEL .....	2.375
Fig. 2-240	Menu SWEEP - LF GEN.....	2.376
Fig. 2-241	Signal example LIST mode: MODE = EXT-STEP.....	2.380
Fig. 2-242	Menu LIST - OPERATION page.....	2.380
Fig. 2-243	Menu List - EDIT page.....	2.382

Fig. 2-244	Menu MEM SEQ -OPERATION-page (preset setting) .....	2.385
Fig. 2-245	Menu MEM SEQ - EDIT page .....	2.386
Fig. 2-246	Menu UTILITIES -SYSTEM -GPIB .....	2.387
Fig. 2-247	Menu UTILITIES - SYSTEM - RS232.....	2.388
Fig. 2-248	Menu UTILITIES - SYSTEM - SERDATA.....	2.389
Fig. 2-249	Menu UTILITIES - SYSTEM-SECURITY.....	2.390
Fig. 2-250	Menu UTILITIES - REF OSC (preset setting).....	2.391
Fig. 2-251	Menu UTILITIES - PHASE (preset setting).....	2.392
Fig. 2-252	Menu UTILITIES - PROTECT (preset setting) .....	2.393
Fig. 2-253	Menu UTILITIES - CALIB - ALL.....	2.394
Fig. 2-254	Menu UTILITIES - CALIB - VCO SUM .....	2.395
Fig. 2-255	Menu UTILITIES - CALIB - VECTOR MOD menu.....	2.396
Fig. 2-256	Menu UTILITIES - CALIB - LEV PRESET .....	2.397
Fig. 2-257	Menu UTILITIES - CALIB - ALC TABLE.....	2.398
Fig. 2-258	Menu UTILITIES - CALIB - LEV ATT.....	2.399
Fig. 2-259	Menu UTILITIES - CALIB – LFGEN .....	2.400
Fig. 2-260	Menu UTILITIES - DIAG - CONFIG.....	2.401
Fig. 2-261	Menu UTILITIES - DIAG - TPOINT .....	2.402
Fig. 2-262	Menu UTILITIES - DIAG - C/N MEAS .....	2.403
Fig. 2-263	Menu UTILITIES - DIAG - PARAM .....	2.404
Fig. 2-264	Menu UTILITIES - MOD KEY (preset setting) .....	2.405
Fig. 2-265	Menu UTILITIES - AUX I/O.....	2.406
Fig. 2-266	Menu UTILITIES - BEEPER .....	2.407
Fig. 2-267	Menu UTILITIES - INSTALL, fitted with options .....	2.408
Fig. 2-268	Menu STATUS page.....	2.409
Fig. 2-269	ERROR page.....	2.410
Fig. 3-1	Tree structure of the SCPI command systems using the SOURce system by way of example .....	3.6
Fig. 3-2	Instrument model in the case of remote control by means of the IEC bus.....	3.205
Fig. 3-3	The status -register model.....	3.208
Fig. 3-4	Overview of the status register .....	3.210
Fig. 4-1	UTILITIES-TEST menu .....	4.2
Fig. A-1	Contact Assignment of the IEC-bus socket.....	A.1
Fig. A-2	Pin assignment of RS-232-C connector .....	A.4
Fig. A-3	Wiring of data, control and signalling lines for hardware handshake .....	A.6

## 3 Remote Control

The instrument is equipped with an IEC-bus interface according to standard IEC 625.1/IEEE 488.2 and a RS-232 interface. The connectors are located at the rear of the instrument and permit to connect a controller for remote control. The instrument supports the SCPI version 1994.0 (Standard Commands for Programmable Instruments). The SCPI standard is based on standard IEEE 488.2 and aims at the standardization of device-specific commands, error handling and the status registers.

This section assumes basic knowledge of IEC-bus programming and operation of the controller. A description of the interface commands is to be obtained from the relevant manuals.

The requirements of the SCPI standard placed on command syntax, error handling and configuration of the status registers are explained in detail in the respective sections. Tables provide a fast overview of the commands implemented in the instrument and the bit assignment in the status registers. The tables are supplemented by a comprehensive description of every command and the status registers. Detailed program examples of the main functions are to be found in annex D. The program examples for IEC-bus programming are all written in QuickBASIC.

**Note:** *In contrast to manual control, which is intended for maximum possible operating convenience, the priority of remote control is the predictability of the device status. This means that when incompatible settings (e.g. activation of PM and FM at the same time) are attempted, the command is ignored and the device status remains unchanged, i.e. is not adapted to other settings. Therefore, IEC/IEEE-bus control programs should always define an initial device status (e.g. with command \*RST) and then implement the required settings.*

### 3.1 Brief Instructions

The short and simple operating sequence given below permits fast putting into operation of the instrument and setting of its basic functions.

#### 3.1.1 IEC-Bus

It is assumed that the IEC-bus address, which is factory-set to 28 has not yet been changed.

1. Connect instrument and controller using IEC-bus cable.
2. Write and start the following program on the controller:

CALL IBFIND("DEV1", generator%)	Open port to the instrument
CALL IBPAD(generator%, 28)	Inform controller about instrument address
CALL IBWRT(generator%, "*RST;*CLS")	Reset instrument
CALL IBWRT(generator%, "FREQ 50MHz")	Set frequency to 50 MHz
CALL IBWRT(generator%, "POW -7.3dBm")	Set output level -7.3m dBm
CALL IBWRT(generator%, "OUTP:STAT ON")	Switch on RF output
CALL IBWRT(generator%, "AM:SOUR INT")	Set AM modulation source LFGEN
CALL IBWRT(generator%, "AM:INT:FREQ 15kHz")	Set modulation frequency to 15 kHz
CALL IBWRT(generator%, "AM 30PCT")	Set AM modulation depth 30%
CALL IBWRT(generator%, "AM:STAT ON")	Switch on AM

An amplitude-modulated signal is now applied at the output of the instrument.

3. To return to manual control, press the LOCAL key at the front panel.

### 3.1.2 RS-232 Interface

It is assumed that the configuration of the RS-232 interface at the unit has not yet been changed.

1. Connect unit and controller using the 0-modem cable.
2. Enter the following command at the controller to configure the controller interface:  
mode com1: 9600, n, 8, 1

3. Create the following ASCII file:

*RST;*CLS	Switch instrument to remote control (Return key)
FREQ 50MHz	Reset instrument
POW -7.3dBm	Set frequency 50 MHz
OUTP:STAT ON	Set output level -7.3 dBm
AM:SOUR INT	Switch on RF output
AM:INT:FREQ 15kHz	Set AM modulation source LFGEN
AM 30PCT	Set modulation frequency 15 kHz
AM:STAT ON	Set AM modulation depth 30%
	Switch on AM
	(Return key)

4. Transfer ASCII file to unit via RS-232 interface. Enter the following command at the controller:

copy <filename> com1:

An amplitude-modulated signal is now applied at the output of the instrument.

5. To return to manual control, press the [LOCAL] key at the front panel.

## 3.2 Switchover to Remote Control

On power-on, the instrument is always in the manual operating state ("LOCAL" state) and can be operated via the front panel.

The instrument is switched to remote control ("REMOTE" state)

IEC-bus as soon as it receives an addressed command from a controller.

RS-232 as soon as it receives either a carriage return <CR> (=0Dh) or a line feed <LF> (0Ah) from a controller.

During remote control, operation via the front panel is disabled. The instrument remains in the remote state until it is reset to the manual state via the front panel or via IEC bus (see Sections 3.2.1.3 and 3.2.2.3). Switching from manual operation to remote control and vice versa does not affect the remaining instrument settings.

### 3.2.1 Remote Control via IEC Bus

#### 3.2.1.1 Setting the Device Address

The IEC-bus address of the instrument is factory-set to 28. It can be changed manually in the UTILITIES-SYSTEM-GPIB-ADDRESS menu or via IEC bus. Addresses 0 to 30 are permissible.

##### Manually:

- Call UTILITIES-SYSTEM-GPIB-ADDRESS menu
- Enter desired address
- Terminate input using the [1x/ENTER] key

##### Via IEC bus:

CALL IBFIND("DEV1", generator%)	Open port to the instrument
CALL IBPAD(generator%, 28)	Inform controller about old address
CALL IBWRT(generator%, "SYST:COMM:GPIB:ADDR 20")	Set instrument to new address
CALL IBPAD(generator%, 20)	Inform controller about new address

#### 3.2.1.2 Indications during Remote Control

The state of the remote control is evident by the words "IEC REMOTE" or "LOCAL" on the STATUS page. The STATUS page is always displayed in the REMOTE state. LOCKED indicates that the key [LOCAL] is disabled, i.e. switchover to manual operation is only possible via IEC/IEEE bus. With UNLOCKED indicated, switchover to manual control is possible via the key [LOCAL] (see also section 3.2.1.3).

#### 3.2.1.3 Return to Manual Operation

Return to manual operation is possible via the front panel or the IEC bus.

**Manually:** ➤ Press the [LOCAL] key.

##### Notes:

- Before switchover, command processing must be completed as otherwise switchover to remote control is effected immediately.
- The [LOCAL] key can be disabled by the universal command LLO (see annex A) in order to prevent unintentional switchover. In this case, switchover to manual mode is only possible via the IEC bus.
- The [LOCAL] key can be enabled again by deactivating the REN control line of the IEC bus (see annex A).

##### Via IEC bus:

...	
CALL IBLOC(generator%)	Set instrument to manual operation.
...	



## 3.2.2 Remote Control via RS-232-Interface

### 3.2.2.1 Setting the Transmission Parameters

To enable an error-free and correct data transmission, the parameters of the unit and the controller should have the same setting. To prevent any problems during binary data transmission, the RS-232 interface is set for 8 data bits, no parity and 1 stop bit. This data format corresponds to the current IEEE P1174 standard. Parameters baud rate and handshake can be manually changed in menu UTILITIES-SYSTEM-RS-232.

- Call UTILITIES-SYSTEM-RS232 menu
- Select desired baudrate and handshake
- Terminate input using the [1x/ENTER] key

### 3.2.2.2 Indications during Remote Control

The state of the remote control is evident by the words "RS-232 REMOTE" or "LOCAL" on the STATUS page. The STATUS page is always displayed in the REMOTE state.

### 3.2.2.3 Return to Manual Operating

Return to manual operation is possible via the front panel.

- Press the [LOCAL] key.

**Note:** Before switchover, command processing must be completed as otherwise switchover to remote control is effected immediately.

## 3.3 Messages

The messages transferred via the data lines of the IEC bus (see annex A) can be divided into two groups:

- **interface messages** and
- **device messages**.

### 3.3.1 Interface Message

Interface messages are transferred on the data lines of the IEC bus, the ATN control line being active. They are used for communication between controller and instrument and can only be sent by a controller which has the IEC-bus control. Interface commands can be subdivided into

- **universal commands** and
- **addressed commands**.

Universal commands act on all devices connected to the IEC bus without previous addressing, addressed commands only act on devices previously addressed as listeners. The interface messages relevant to the instrument are listed in annex A.

Some control characters are defined for the control of the RS-232-interface (see annex A)

### 3.3.2 Device Messages (Commands and Device Responses)

Device messages are transferred on the data lines of the IEC bus, the "ATN" control line not being active. ASCII code is used. The device messages are largely identical for the two interfaces (IEC bus and RS232) .

A distinction is made according to the direction in which they are sent on the IEC bus:

- **Commands** are messages the controller sends to the instrument. They operate the device functions and request information.  
The commands are subdivided according to two criteria:
  1. According to the effect they have on the instrument:
    - Setting commands** cause instrument settings such as reset of the instrument or setting the output level to 1 volt.
    - Queries** cause data to be provided for output on the IEC-bus, e.g. for identification of the device or polling the active input.
  2. According to their definition in standard IEEE 488.2:
    - Common Commands** are exactly defined as to their function and notation in standard IEEE 488.2. They refer to functions such as management of the standardized status registers, reset and selftest.
    - Device-specific commands** refer to functions depending on the features of the instrument such as frequency setting. A majority of these commands has also been standardized by the SCPI committee (cf. Section 3.4.1).
- **Device responses** are messages the instrument sends to the controller after a query. They can contain measurement results, instrument settings and information on the instrument status (cf. Section 3.4.4).

Structure and syntax of the device messages are described in Section 3.4. The commands are listed and explained in detail in Section 3.5.

## 3.4 Structure and Syntax of the Device Messages

### 3.4.1 SCPI Introduction

SCPI (Standard Commands for Programmable Instruments) describes a standard command set for programming instruments, irrespective of the type of instrument or manufacturer. The goal of the SCPI consortium is to standardize the device-specific commands to a large extent. For this purpose, a model was developed which defines the same functions inside a device or for different devices. Command systems were generated which are assigned to these functions. Thus it is possible to address the same functions with identical commands. The command systems are of a hierarchical structure. Fig. 3-1 illustrates this tree structure using a section of command system SOURce, which operates the signal sources of the devices. The other examples concerning syntax and structure of the commands are derived from this command system.

SCPI is based on standard IEEE 488.2, i.e. it uses the same syntactic basic elements as well as the common commands defined in this standard. Part of the syntax of the device responses is defined with greater restrictions than in standard IEEE 488.2 (see Section 3.4.4, Responses to Queries).

### 3.4.2 Structure of a Command

The commands consist of a so-called header and, in most cases, one or more parameters. Header and parameter are separated by a "white space" (ASCII code 0 to 9, 11 to 32 decimal, e.g. blank). The headers may consist of several key words. Queries are formed by directly appending a question mark to the header.

**Note:** The commands used in the following examples are not in every case implemented in the instrument.

#### Common Commands

Common commands consist of a header preceded by an asterisk "\*" and one or several parameters, if any.

Examples: \*RST           RESET, resets the device  
 \*ESE 253       EVENT STATUS ENABLE, sets the bits of the event status enable registers  
 \*ESR?          EVENT STATUS QUERY, queries the contents of the event status register.

#### Device-specific commands

Hierarchy:

Device-specific commands are of hierarchical structure (see Fig. 3-1). The different levels are represented by combined headers. Headers of the highest level (root level) have only one key word. This key word denotes a complete command system.

Example: SOURce       This key word denotes the command system SOURce.

For commands of lower levels, the complete path has to be specified, starting on the left with the highest level, the individual key words being separated by a colon ":".

Example: :SOURce:FM:EXTernal:COUpling AC

This command lies in the fourth level of the SOURce system. It sets the coupling of the external signal source to AC.

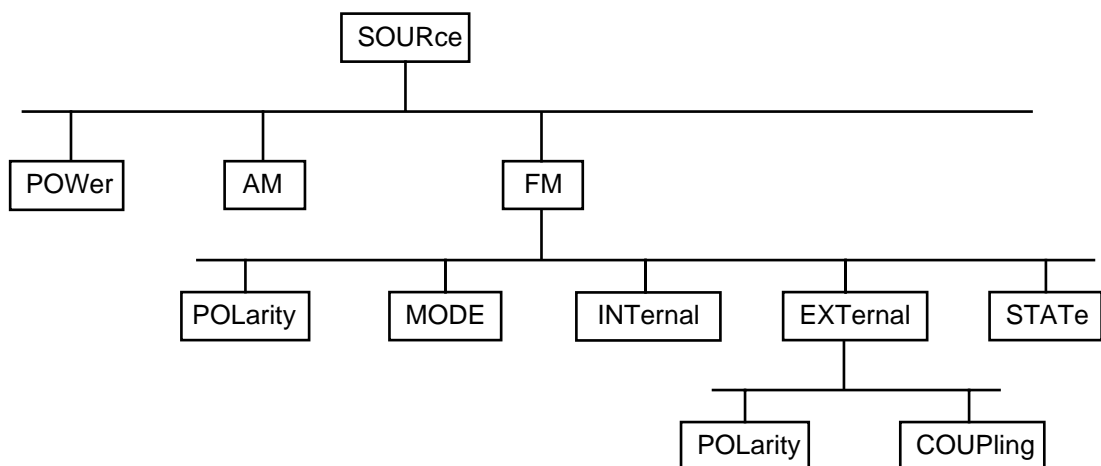

Fig. 3-1 Tree structure of the SCPI command systems using the SOURce system by way of example

Some key words occur in several levels within one command system. Their effect depends on the structure of the command, that is to say, at which position in the header of a command they are inserted.

Example: `SOURce:FM:POLarity NORMal`

This command contains key word POLarity in the third command level. It defines the polarity between modulator and modulation signal.

`SOURce:FM:EXTernal:POLarity NORMal`

This command contains key word POLarity in the fourth command level. It defines the polarity between modulation voltage and the resulting direction of the modulation only for the external signal source indicated.

Optional key words: Some command systems permit certain key words to be optionally inserted into the header or omitted. These key words are marked by square brackets in the description. The full command length must be recognized by the instrument for reasons of compatibility with the SCPI standard. Some commands are considerably shortened by these optional key words.

Example: `[SOURce]:POWer[:LEVel][:IMMediate]:OFFSet 1`

This command immediately sets the offset of the signal to 1 volt. The following command has the same effect:

`POWer:OFFSet 1`

**Note:** *An optional key word must not be omitted if its effect is specified in detail by a numeric suffix.*

Long and short form: The key words feature a long form and a short form. Either the short form or the long form can be entered, other abbreviations are not permissible.

Example: `STATus:QUESTionable:ENABle 1= STAT:QUES:ENAB 1`

**Note:** *The short form is marked by upper-case letters, the long form corresponds to the complete word. Upper-case and lower-case notation only serve the above purpose, the instrument itself does not make any difference between upper-case and lower-case letters.*

Parameter: The parameter must be separated from the header by a "white space". If several parameters are specified in a command, they are separated by a comma ",". A few queries permit the parameters MINimum, MAXimum and DEFault to be entered. For a description of the types of parameter, refer to Section 3.4.5.

Example: `SOURce:POWer:ATTenuation? MAXimum Response: 60`

This query requests the maximal value for the attenuation.

Numeric suffix: If a device features several functions or features of the same kind, e.g. inputs, the desired function can be selected by a suffix added to the command. Entries without suffix are interpreted like entries with the suffix 1.

Example: `SOURce:FM:EXTernal2:COUPling AC`

This command sets the coupling of the second external signal source.

### 3.4.3 Structure of a Command Line

A command line may consist of one or several commands. It is terminated by a <New Line>, a <New Line> with EOI or an EOI together with the last data byte. Quick BASIC automatically produces an EOI together with the last data byte.

Several commands in a command line are separated by a semicolon ";". If the next command belongs to a different command system, the semicolon is followed by a colon.

Example:

```
CALL IBWRT(generator%, "SOURCE:POWER:CENTER MINIMUM;:OUTPUT:ATTENUATION 10")
```

This command line contains two commands. The first command is part of the SOURCE system and is used to specify the center frequency of the output signal. The second command is part of the OUTPUT system and sets the attenuation of the output signal.

If the successive commands belong to the same system, having one or several levels in common, the command line can be abbreviated. To this end, the second command after the semicolon starts with the level that lies below the common levels (see also Fig. 3-1). The colon following the semicolon must be omitted in this case.

Example:

```
CALL IBWRT(generator%, "SOURCE:FM:MODE LOCKED;:SOURCE:FM:INTERNAL:FREQUENCY 1kHz")
```

This command line is represented in its full length and contains two commands separated from each other by the semicolon. Both commands are part of the SOURCE command system, subsystem FM, i.e. they have two common levels.

When abbreviating the command line, the second command begins with the level below SOURCE:FM. The colon after the semicolon is omitted.

The abbreviated form of the command line reads as follows:

```
CALL IBWRT(generator%, "SOURCE:FM:MODE LOCKED;INTERNAL:FREQUENCY 1kHz")
```

However, a new command line always begins with the complete path.

Example: `CALL IBWRT(generator%, "SOURCE:FM:MODE LOCKED")`  
`CALL IBWRT(generator%, "SOURCE:FM:INTERNAL:FREQUENCY 1kHz")`

### 3.4.4 Responses to Queries

A query is defined for each setting command unless explicitly specified otherwise. It is formed by adding a question mark to the associated setting command. According to SCPI, the responses to queries are partly subject to stricter rules than in standard IEEE 488.2.

1. The requested parameter is transmitted without header.

Example: `SOURCE:EXTERNAL:COUPLING?` Response: AC

2. Maximum values, minimum values and all further quantities, which are requested via a special text parameter are returned as numerical values.

Example: `FREQUENCY? MAX` Response: 10E3

3. Numerical values are output without a unit. Physical quantities are referred to the basic units or to the units set using the Unit command.

Example: `FREQUENCY?` Response: 1E6 for 1 MHz

4. Truth values <Boolean values> are returned as 0 (for OFF) and 1 (for ON).

Example: `OUTPUT:STATE?` Response: 1

5. Text (character data) is returned in a short form (see also Section 3.4.5).

Example: `SOURCE:FM:SOURCE?` Response: INT

### 3.4.5 Parameter

Most commands require a parameter to be specified. The parameters must be separated from the header by a "white space". Permissible parameters are numerical values, Boolean parameters, text, character strings and block data. The type of parameter required for the respective command and the permissible range of values are specified in the command description (see Section 3.5).

**Numerical values** Numerical values can be entered in any form, i.e. with sign, decimal point and exponent. Values exceeding the resolution of the instrument are rounded up or down. The allowed range is  $-9.9E37$  to  $+9.9E37$ . The exponent is introduced by an "E" or "e". Entry of the exponent alone is not permissible. In the case of physical quantities, the unit can be entered. Permissible unit prefixes are G (giga), MA (mega), MOHM and MHZ are also permissible), K (kilo), M (milli), U (micro) and N (nano). If the unit is missing, the basic unit is used.

Example: `SOURce:FREQuency 1.5 kHz = SOURce:FREQuency 1.5E3`

**Special numerical values** The texts MINimum, MAXimum, DEFault, UP and DOWN are interpreted as special numerical values.

In the case of a query, the numerical value is provided.

Example: Setting command: `SOURce:VOLTage MAXimum`  
 Query: `SOURce:VOLTage?` Response: 15

MIN/MAX MINimum and MAXimum denote the minimum and maximum value.

DEF DEFault denotes a preset value which has been stored in the EPROM. This value conforms to the default setting, as it is called by the \*RST command.

UP/DOWN UP, DOWN increases or reduces the numerical value by one step. The step width can be specified via an allocated step command (see annex C, List of Commands) for each parameter which can be set via UP, DOWN.

INF/NINF INFINITY, Negative INFINITY (NINF) represent the numerical values  $-9.9E37$  or  $9.9E37$ , respectively. INF and NINF are only sent as device responses.

NAN Not a Number (NAN) represents the value  $9.91E37$ . NAN is only sent as device response. This value is not defined. Possible causes are the division of zero by zero, the subtraction of infinite from infinite and the representation of missing values.

**Boolean Parameters** Boolean parameters represent two states. The ON state (logically true) is represented by ON or a numerical value unequal to 0. The OFF state (logically untrue) is represented by OFF or the numerical value 0. 0 or 1 is provided in a query.

Example: Setting command: `SOURce:FM:STATE ON`  
 Query: `SOURce:FM:STATE?` Response: 1

**Text** Text parameters observe the syntactic rules for key words, i.e. they can be entered using a short or long form. Like any parameter, they have to be separated from the header by a white space. In the case of a query, the short form of the text is provided.

Example: Setting command: `OUTPut:FILTer:TYPE EXTernal`  
 Query: `OUTPut:FILTer:TYPE?` Response: EXT

**Strings** Strings must always be entered in quotation marks (' or ").

Example: `SYSTem:LANGUage "SCPI"` or  
`SYSTem:LANGUage 'SCPI'`

**Block data**

Block data are a transmission format which is suitable for the transmission of large amounts of data. A command using a block data parameter has the following structure:

Example: `HEADer:HEADer #45168xxxxxxxx`

ASCII character # introduces the data block. The next number indicates how many of the following digits describe the length of the data block. In the example the 4 following digits indicate the length to be 5168 bytes. The data bytes follow. During the transmission of these data bytes all End or other control signs are ignored until all bytes are transmitted. Data elements comprising more than one byte are transmitted with the byte being the first which was specified by SCPI command "FORMat:BORDer". Here, the command `:SYSTem:COMMunicate:GPIB:LTERminator EOI` should be used to set the delimiter mode to 'circuit message EOI only' so that an accidental LF within the data sequence is not first identified as a delimiter and thus momentarily interrupts the data transmission. The command `...LTER STANDard` resets the delimiter mode.

The format of the binary files within the block depends on the IEC-bus command

The commands

```
:SOURce:LIST:FREQuency
:SOURce:LIST:POWer
:SOURce:CORRection:CSET:DATA:FREQuency
:SOURce:CORRection:CSET:DATA:POWer
:SOURce:DATA:AM
:SOURce:DATA:AMBase
:SOURce:DATA:PM
:SOURce:DATA:PMBase
:SYSTem:MSEQuence:DWELL
:SYSTem:MSEQuence:RCL
```

use the IEEE-754 format for double precision floating point numbers. Each number is represented by 8 bytes.

**Example:**

`a# = 125.345678E6`

`b# = 127.876543E6`

```
CALL IBWRT(generator%, "SOURCE:CORRECTION:CSET:DATA:FREQ
#216" + MKD$(a#) + MKD$(b#))
```

- '#' in the command string introduces the binary block,
- '2' indicates that 2 digits specifying the length will follow next,
- '16' is the length of the binary block (in bytes), here: 2 double precision floating pooint number with 8 bytes each.
- The actual binary data follow now. As the function IBWRT requires a text string, MKD\$ is used for the type conversion.

The following ASCII format has the same effect:

```
CALL IBWRT(generator%, "SOURCE:CORRECTION:CSET:DATA:FREQ
125.345678E6, 127.876543E6")
```

### 3.4.6 Overview of Syntax Elements

The following survey offers an overview of the syntax elements.

:

The colon separates the key words of a command.  
In a command line the separating semicolon marks the uppermost command level.

;

The semicolon separates two commands of a command line.  
It does not alter the path.

,

The comma separates several parameters of a command.

?

The question mark forms a query.

\*

The asterisk marks a common command.

"

Double or single quotation marks introduce a string and terminate it.

'

#

The double dagger # introduces block data.

A "white space" (ASCII-Code 0 to 9, 11 to 32 decimal, e.g. blank) separates header and parameter.



## 3.5 Description of Commands

### 3.5.1 Notation

In the following sections, all commands implemented in the instrument are first listed in tables and then described in detail, separated according to the command system. The notation corresponds to the one of the SCPI standards to a large extent. The SCPI conformity information can be taken from the list of commands in annex C.

#### Table of Commands

Command:	In the command column, the table provides an overview of the commands and their hierarchical arrangement (see indentations).
Parameter:	In the parameter column the requested parameters are indicated together with their specified range.
Unit:	The unit column indicates the basic unit of the physical parameters.
Remark:	In the remark column an indication is made on <ul style="list-style-type: none"> <li>- whether the command does not have a query form,</li> <li>- whether the command has only one query form ,</li> <li>- whether this command is implemented only with a certain option of the instrument.</li> </ul>

#### Indentations

The different levels of the SCPI command hierarchy are represented in the table by means of indentations to the right. The lower the level is, the farther the indentation to the right is. Please observe that the complete notation of the command always includes the higher levels as well.

Example: `:SOURCE:FM:MODE` is represented in the table as follows:

<code>:SOURCE</code>	first level
<code>:FM</code>	second level
<code>:MODE</code>	third level

In the individual description, the complete notation of the command is given. An example for each command is written out at the end of the individual description.

#### Upper/lower case notation

Upper/lower case letters serve to mark the long or short form of the key words of a command in the description (see Section 3.4.2). The instrument itself does not distinguish between upper and lower case letters.

**Special characters** | A selection of key words with an identical effect exists for several commands. These key words are indicated in the same line, they are separated by a vertical stroke. Only one of these key words has to be indicated in the header of the command. The effect of the command is independent of which of the key words is indicated.

Example: :SOURce  
:FREQuency  
:CW|:FIXed

The two following commands of identical meaning can be formed. They set the frequency of the constantly frequent signal to 1 kHz:

SOURce:FREQuency:CW 1E3 = SOURce:FREQuency:FIXed 1E3

A vertical stroke in indicating the parameters marks alternative possibilities in the sense of "or". The effect of the command is different, depending on which parameter is entered.

Example: Selection of the parameters for the command

SOURce:COUPling AC | DC

If parameter AC is selected, only the AC content is fed through, in the case of DC, the DC as well as the AC content.

[ ] Key words in square brackets can be omitted when composing the header (cf. Section 3.4.2, Optional Keywords). The full command length must be accepted by the instrument for reasons of compatibility with the SCPI standards.

Parameters in square brackets can optionally be incorporated in the command or omitted as well.

{ } Parameters in braces can optionally be incorporated in the command either not at all, once or several times.

### 3.5.2 Common Commands

The common commands are taken from the IEEE 488.2 (IEC 625-2) standard. Some commands have the same effect on different devices. The headers of these commands consist of an asterisk "\*" followed by three letters. Many common commands refer to the status reporting system which is described in detail in Section 3.7.

Table 3-1 Common Commands

Command	Parameter	Unit	Remark
*CLS			No query
*ESE	0 to 255		
*ESR?			Only query
&GTL			
*IDN?			Only query
*IST?			Only query
*OPC			
*OPC?			Only query
*OPT?			Only query
*PRE	0 to 255		
*PSC	0   1		
*RCL	0 to 50		No query
*RST			No query
*SAV	1 to 50		No query
*SRE	0 to 255		
*STB?			Only query
*TRG			No query
*TST?			Only query
*WAI			No query

#### \*CLS

**CLEAR STATUS** sets the status byte (STB), the standard event register (ESR) and the EVENT-part of the QUESTIONable and the OPERATION register to zero. The command does not alter the mask and transition parts of the registers. It clears the output buffer

#### \*ESE 0 to 255

**EVENT STATUS ENABLE** sets the event status enable register to the value indicated. Query \*ESE? returns the contents of the event status enable register in decimal form.

#### \*ESR?

**STANDARD EVENT STATUS QUERY** returns the contents of the event status register in decimal form (0 to 255) and subsequently sets the register to zero.

**&GTL**

**GO TO LOCAL:** The IEC bus (IEEE488) includes line message REN (remote enable). If the device is controlled via a serial interface (RS-232), a remote/local switchover is not possible with this line. This new command in line with IEEE1174 has been therefore introduced so that the device can be switched to local mode via remote control (in the same way as with the front-panel LOCAL key). The device automatically goes to the remote status as soon as the first remote command has been received. The command is also of importance when the device is to be controlled alternately via the IEC/IEEE bus and the serial interface. The device should go to local before it can recognize a command from the other interface.

**\*IDN?**

**IDENTIFICATION QUERY** queries the instrument identification.

The device response is for example: "Rohde&Schwarz, SMIQ03B,00000001, 1.03"

03B = variant identification

00000001= serial number

1.03 = firmware version number

**\*IST?**

**INDIVIDUAL STATUS QUERY** returns the contents of the IST flag in decimal form (0 | 1). The IST flag is the status bit which is sent during a parallel poll (cf. Section 3.6.3.2).

**\*OPC**

**OPERATION COMPLETE** sets bit 0 in the event status register when all preceding commands have been executed. This bit can be used to initiate a service request (cf. Section 3.6).

**\*OPC?**

**OPERATION COMPLETE QUERY** returns 1, if all preceding commands have been executed. It is necessary to consider a sufficiently long time-out for the IEEE/IEC-bus.

**\*OPT?**

**OPTION IDENTIFICATION QUERY** queries the options included in the instrument and returns a list of the options installed. The options are separated from each other by means of commas.

Table 3-2 List of possible responses to \*OPT?

Response	Option
SM-B1	Reference oscillator OCXO
SM-B5	FM/PM modulator
SMIQB10	Modulation coder
SMIQB11	Data generator
SMIQB12	Memory extension for SMIQB11
SMIQB12	Second memory extension
SMIQB14	Fading simulator
SMIQB15	Second fading simulator
SMIQB16	Broadband FM
SMIQB17	Noise generator/distortion simulator
SMIQB20	Modulation coder
SMIQB21	Bit error rate test
SMIQB43	Digital Standard W-CDMA
SMIQB45	Digital Standard 3GPP W-CDMA
SMIQB47	LOW ACP Filter
SMIQB48	Enhanced Channels for 3GPP W-CDMA
SMIQB49	Dynamic Fading

Example for a device response:

SM-B1, SM-B5, SMIQB10, SMIQB11, SMIQB12, SMIQB12, SMIQB14, SMIQB15, 0

**\*PRE** 0 to 255

**PARALLEL POLL REGISTER ENABLE** sets the parallel poll enable register to the value indicated. Query \*PRE? returns the contents of the parallel poll enable register in decimal form.

**\*PSC** 0 | 1

**POWER ON STATUS CLEAR** determines whether the contents of the ENABLE registers is maintained or reset in switching on.

\*PSC = 0 causes the contents of the status registers to be maintained. Thus a service request can be triggered in switching on in the case of a corresponding configuration of status registers ESE and SRE.

\*PSC ≠ 0 resets the registers.

Query \*PSC? reads out the contents of the power-on-status-clear flag. The response can be 0 or 1.

**\*RCL** 0 to 50

**RECALL** calls the instrument state which was stored under the number supplied using command \*SAV. 50 instrument states can be stored.

**\*RST**

**RESET** sets the instrument to a defined default status. The command essentially corresponds to pressing the [PRESET] key. The state of the RF-output is an exception: The RF-output is deactivated after \*RST, however, it is activated after the [PRESET] key has been pressed. The default setting is indicated in the description of the commands.

**\*SAV** 1 to 50

**SAVE** stores the current instrument state under the number indicated (cf. \*RCL as well).

**\*SRE** 0 to 255

**SERVICE REQUEST ENABLE** sets the service request enable register to the value indicated. Bit 6 (MSS mask bit) remains 0. This command determines under which conditions a service request is triggered. Query \*SRE? reads the contents of the service request enable register in decimal form. Bit 6 is always 0.

**\*STB?**

**READ STATUS BYTE QUERY** reads out the contents of the status byte in decimal form.

**\*TRG**

**TRIGGER** triggers all actions waiting for a trigger event. Special trigger events can be started by command system "TRIGger" (see section "TRIGger System").

**\*TST?**

**SELF TEST QUERY** triggers all selftests of the instrument indicated in Chapter 4, Section "Functional Test" and outputs an error code in decimal form.

**\*WAI**

**WAIT-to-CONTINUE** only permits the servicing of the subsequent commands after all preceding commands have been executed and all signals have settled (cf. Section 3.6 and "\*OPC" as well).

### 3.5.3 ABORt System

The ABORt system contains the commands to abort actions triggered. After an action has been aborted, it can be triggered again at once. All commands trigger an event, thus they have no \*RST value.

Further commands for the trigger system of the SMIQ can be found in the TRIGger system.

Command	Parameter	Default Unit	Remark
:ABORt [:SWEep] :LIST :MSEquence			No query No query No query

#### :ABORt[:SWEep]

The command aborts a sweep.

Example: :ABOR:SWE

#### :ABORt:LIST

The command aborts a list execution.

Example: :ABOR:LIST

#### :ABORt:MSEquence

The command aborts a Memory Sequence.

Example: :ABOR:MSEQ

### 3.5.4 ARB System

Refer to chapter "ARB Waveform Format" following the information on the IEC/IEEE bus commands where explanation of waveform formats and tags is provided.

Command	Parameter	Default unit	Remarks
<b>:ARB</b>			
<b>:STATe</b>	ON   OFF		
<b>:SEQuence</b>	AUTO   RETRigger   AAUTo   ARETrigger		
<b>:WAVeform</b>			
<b>:SElect</b>	'name'		
<b>:DELete</b>	'name'		No query
<b>:DATA</b>	'name', <blockdata>		Not readable
<b>:CATalog?</b>	⇒ name[,name]...		Query only
<b>:LENGth?</b>	⇒ n		Query only
<b>:TAG? '&lt;tagname&gt;'</b>	⇒ <string>		Query only
<b>:FREE?</b>	⇒ n		Query only
<b>:POINts?</b>	⇒ n		Query only
<b>:TRIGger</b>			
<b>:SOURce</b>	INTernal   EXTernal		
<b>:DELay</b>	0 to 65 535	(clocks)	
<b>:INHibit</b>	0 to 67.1E6	(clocks)	
<b>:OUTPut&lt;i&gt;</b>	with <i> = [1]   2		
<b>:POLarity</b>	POSitive   NEGative		
<b>:DELay</b>	0 to 524 255	(clocks)	
<b>:MODE</b>	USER   'mode_string'		
<b>CATalog?</b>	⇒ name[,name]...		Query only
<b>:ONTime</b>	0 to 524 255	(clocks)	
<b>:OFFTime</b>	0 to 524 255	(clocks)	
<b>:ASET</b>			
<b>:STATe</b>	ON   OFF		
<b>:DM</b>			
<b>:IQFilter</b>	ON   OFF		
<b>:IQSWap</b>	ON   OFF		
<b>:BERT</b>			
<b>:TYPE</b>	ON   OFF		
<b>:TRIGger</b>			
<b>:MODE</b>	ON   OFF		
<b>:CLOCK</b>	1 kHz to 40.0 MHz	Hz	
<b>:SOURce</b>	INTernal   EXTernal		
<b>:DELay</b>	0.0 to 0.99	(clocks)	
<b>:IQ</b>			
<b>:LEVel</b>	-3 to 6	dB	
<b>:MODE</b>	MANuell   AUTO		
<b>:SKEW</b>	-1000...1000	ps	

**:ARB:STATe ON | OFF**

This command switches on (ON) or off (OFF) the arbitrary waveform generator.

Example:    :ARB:STAT ON

\*RST value is OFF

**:ARB:SEquence** AUTO | RETRigger | AAUTo | ARETrigger

This command configures the sequence control of the ARB mode.

AUTO The waveform is repeated in cycles.

RETRigger Cyclic repetition; new start upon trigger.

AAUTo Armed Auto; starts after a trigger event, further triggers are ignored.

ARETrigger Armed Retrigger; starts after a trigger event, each new trigger initiates a new start.

Example: :ARB:SEQ RETR \*RST value is AUTO

**:ARB:WAVeform:SElect** '<name>'

This command is used to select a waveform to be the active waveform.

Example: :ARB:WAV:SEL 'name'

**:ARB:WAVeform:DElete** '<name>'

This command is used to select a waveform to be deleted. This command triggers an event and, therefore, has no \*RST value.

Example: :ARB:WAV:DEL 'name'

**:ARB:WAVeform:DATA** '<name>', <binary block data>

This command is used to load waveform data into the SMIQ and store them under a name. Refer to chapter "ARB Waveform Format" for more detailed information on this command.

Example: :ARB:WAV:DATA 'name'

**:ARB:WAVeform:CATalog?**

This command calls the list of all waveforms.

Example: :ARB:WAV:CAT?

**:ARB:WAVeform:CATalog:LENGth?**

This command requests for the number of waveforms in the list.

Example: :ARB:WAV:CAT:LENG?

**:ARB:WAVeform:TAG?** '<tagname>'

This command requests for the content of a tag. Refer to the following chapter "ARB Waveform Format" for more detailed information on tags.

Example: :ARB:WAV:TAG 'tagname'



**:ARB:WAVeform:FREE?**

This command requests for free memory space for further waveforms.

Example: :ARB:WAV:FREE?

**:ARB:WAVeform:POINTs?**

This command returns the number of samples contained in a waveform.

Example: :ARB:WAV:POIN?

**:ARB:TRIGger:SOURce INTernal | EXTernal**

This command allows for configuration of the trigger source.

INT Triggering via IEC/IEEE bus or using the Execute comment of manual control.

EXT Triggering via the external trigger input.

Example: :ARB:TRIG:SOUR EXT \*RST value INT

**:ARB:TRIGger:DELay 0 to 65 535**

This command is used to enter the trigger delay (as number of samples).

Example: :ARB:TRIG:DEL 234 \*RST value is 0

**:ARB:TRIGger:INHibit 0 to 67.1E6**

This command sets the time of trigger inhibition (as number of samples).

Example: :ARB:TRIG:INH 345 \*RST value is 0

**:ARB:TRIGger:OUTPut[1]|2:POLarity POSitive | NEGative**

This command is used to define the signal polarity at the trigger output. I

POSitive positive voltage with active state

NEGative voltage 0 or low, positive with active state

Example: :ARB:TRIG:OUTP2:POL POS \*RST value is NEG

**:ARB:TRIGger:OUTPut[1]|2:DELay 0 to 524 255**

This command defines the signal delay at the trigger output indicated as number of samples.

Example: :ARB:TRIG:OUTP2:DEL 765 \*RST value is 0

**:ARB:TRIGger:OUTPut[1]|2:MODE USER | 'mode\_string'**

This command allows for selection of a mode for generation of the trigger output signals. The counters for ON TIME and OFF TIME are set.

Example: :ARB:TRIG:OUTP2:MODE USER \*RST value is USER

**:ARB:TRIGger:OUTPut[1]|2:MODE:CATalog?**

This command initiates the output of a list of all available modes.

Example: :ARB:TRIG:OUTP2:MODE:CAT?

**:ARB:TRIGger:OUTPut[1]2:ONTime** 0 to 524 255

This command sets the length of the active state of output trigger signals (indicated as number of samples). Setting is only possible, if :ARB:TRIG:OUTP:MODE is set to USER.

Example: :ARB:TRIG:OUTP2:ONT 765 \*RST value is 0

**:ARB:TRIGger:OUTPut[1]2:OFFTime** 0 to 524 255

This command sets the length of the non-active state of output trigger signals (indicated as number of samples). Setting is only possible, if :ARB:TRIG:OUTP:MODE is set to USER.

Example: :ARB:TRIG:OUTP2:OFFT 765 \*RST value is 0

**:ARB:ASET:STATe** ON | OFF

This command is used to switch on (ON) or off (OFF) the automatic setting of the SMIQ parameters by the waveform to be loaded.

Example: :ARB:ASET:STAT ON \*RST value is OFF

**:ARB:ASET:DM:IQFilter** ON | OFF

This command is used to set the parameter IQ FILTER in the VECTOR MOD menu (ON) or it remains unaffected (OFF). Commands :DM:IQ:FILT:STAT and :DM:IQ:FILT:FREQ.

Example: :ARB:ASET:DM:IQF ON \*RST value is OFF

**:ARB:ASET:DM:IQSWap** ON | OFF

This command is used to set the parameter IQ SWAP in the VECTOR MOD menu (ON) or it remains unaffected (OFF). Command :DM:IQSW:STAT.

Example: :ARB:ASET:DM:IQSW ON \*RST value is OFF

**:ARB:ASET:BERT:TYPE** ON | OFF

This command is used to set the type of PRBS in the BERT menu (ON) or it remains unaffected (OFF). Command :BERT:SET:TYPE.

Example :ARB:ASET:BERT:TYPE ON \*RST value is OFF

**:ARB:ASET:TRIGger:MODE** ON | OFF

This command is used to set the parameters TRIGGER OUT1 MODE and TRIGGER OUT2 MODE in the ARB MOD TRIGGER...menu. Command :ARB:TRIG:OUTP:MODE.

Example: :ARB:ASET:TRIG:MODE ON \*RST value is OFF

**:ARB:CLOCK** 1kHz to 40.0 MHz

This command specifies the entry value for the sample clock.

Example: :ARB:CLOC 4.096MHz \*RST value is 0

**:ARB:CLOCK:SOURce** INTernal | EXTernal

This command is used to select the source for the sample clock.

INTernal The internal clock generator is used.

EXTernal The clock is applied externally at the socket.

Example: :ARB:CLOC:SOUR EXT

\*RST value is INT

**:ARB:CLOCK:DELay** 0.0 to 0.99

This command is used to set the delay of the modulation signal against the clock signal.

Example: :ARB:CLOC:DEL 0.55

\*RST value is 0

**:ARB:IQ:LEVel** -3 dB to +6 dB

This command sets the IQ level referred to maximum input level.

Example: :ARB:IQ:LEV 1

\*RST value is 0

**:ARB:IQ:LEVel:MODE** MANUell | AUTO

This command is used to select the operating mode for setting the IQ level.

MANual Level setting with subsequent entry.

AUTO Automatic level setting to 0.5 V.

Example: :ARB:IQ:LEV:MODE MAN

\*RST value is AUTO

**:ARB:IQ:SKEW** -1000...1000 ps

The command determines the delay between I and Q channel.

Example: :ARB:IQ:SKEW -250ps

\*RST value is 0

### 3.5.4.1 ARB Waveform Format

**Waveform format** The waveform format is used for transmission via the IEC/IEEE bus and the serial interface, it is packed in a binary block command.

**Tags** A tag-oriented format is used. Tags are self-contained information units. They have the general format

**{Name: Data} or {Name-length: Data}**

The colon separates the name and data sections. For the sake of clarity the colon is always followed by a blank.

**Name** identifies the day. It is always specified in upper-case characters.

**Data** are tag-specific but in most cases plain text in ASCII format.

**Length** indicates the number of bytes of the WAVEFORM tag and consists of:

number of digits of the <b>Start</b> -value	(1 to 7)
+ length of ",#" (2 bytes)	
+ number of I/Q pairs * 4	(2 bytes for each I and Q-value).

**Several tags in one waveform** Tags may be interleaved. Normally the order of the tags within a waveform is irrelevant, but there may be exceptions. All tags can but need not be contained in a waveform. Exceptions are described with the individual tags.

Unknown tags are not evaluated by the SMIQ but are stored unchanged and without an error message and can be read again.

The following tags are defined:

**{TYPE: magic, xxxxxxxx}**

**(indispensable)**

The TYPE tag identifies this waveform as a valid SMIQ waveform. The tag must be the first tag in the waveform. xxxxxxxx is an ASCII-coded checksum over the data range of the WAVEFORM tag in this waveform. It is calculated by the following algorithm where 'start' is a pointer to the first byte after the double dagger '#' sign in the WAVEFORM tag and 'length' denotes the number of bytes between 'start' and the final brace (excluding the latter; 'length' must be a multiple of 4):

```
UINT32 checksum(void *start, UINT32 length)
{
    UINT32 i, result = 0xA50F74FF;

    for(i=0; i < length/4; i++)
        result = result ^ ((UINT32 *)start)[i];

    return(result);
}
```

The checksum is used for recognizing transmission errors. If the TYPE tag contains 0 or a non-numerical value for the checksum, it is ignored by the SMIQ.

'magic' identifies the type of the waveform and has the following value:

**WV** The waveform is a complete, self-contained waveform. When already available on the target medium, the previous version is overwritten.

**Note:** *Because of the flexible, tag-based form of the waveforms, a version number is not required.*

**{CLOCK: frequency}** (indispensable)

This tag specifies the clock frequency with which the waveform should be output. A query of ARB:CLOCK? after loading the waveform returns the values set by means of the {CLOCK: . . .} tag.

**{COMMENT: string}** (Important for TYPE = WV\_ADD)

The tag contains a plain-text ASCII string of any length. The string is not evaluated in the SMIQ, it serves for the output of keywords on the PC and for describing the waveform. The string may contain all printable ASCII characters except the closing brace.

**{COPYRIGHT: string}** (optional)

This tag contains the name under which WinIQSIM (or other programs for waveform generation) are registered. The string may contain all printable ASCII characters except the closing brace.

**{DATE: yyyy-mm-dd;hh:mm:ss}** (optional)

This tag contains date and time at which the waveform was generated. The year should be specified with four digits. The SMIQ does not evaluate this tag.

**{WAVEFORM-length: 0, #xxxxxxxxxxxx...}** (indispensable)

This tag contains the actual waveform data.

The quantity *length* indicates the number of bytes of the WAVEFORM tag and consists of:

- + length of ",#" (2 bytes)
- + number of I/Q pairs \* 4 (2 bytes for each I and Q-value).

**Example:**

{WAVEFORM-403:0, # I Q I Q I Q I Q ..... I Q }

403 Bytes

xxxxxx... are binary(!) data, that alternately contain I and Q samples, the first sample being a I sample. Each sample consists of two bytes, the least-significant one (LSByte) is the first.

The two bytes of a sample cover the value range 0x300 to 0xFD00 (0x768 to 64768). This value is transferred to the D/A converter unchanged.

Different output levels are applied to the output connectors of the SMIQ:

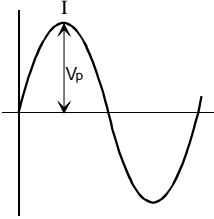
	Binary value of the sample	Asymmetric outputs
	identical with the value of the waveform D/A converter	amplitude $V_p$ at $50 \Omega$ between inner and outer conductor of I and Q output  Valid as Q output also!
OUTP:I Q FIX	0x300 (768) 0x8000 (32768) 0xFD00 (64768)	0 V 0.25 V 0.5 V
OUTP:I Q VAR	0x300 (768)	0 V
OUTP:I Q INV Same level as the waveform for VAR, phase shifted by 180°	0x8000 (32768) 0xFD00 (64768)	0.5 V 1 V

### 3.5.4.2 Creating a Waveform „Manually“

We will use to example of a sine function in the I channel and a cosine function in the Q channel, each with 20 points, to explain how a waveform file SICO.WV is generated.

The sine and cosine values are calculated by a short program written in the programming language C (see the following example for creating a C-program). They are stored in the file SICO.TXT as follows:

**Contents of SICO.TXT:**

Sine (I)      Cosine (Q)

0.000000	1.000000
0.309017	0.951057
0.587785	0.809017
0.809017	0.587785
0.951057	0.309017
1.000000	-0.000000
0.951056	-0.309017
0.809017	-0.587785
0.587785	-0.809017
0.309017	-0.951056
-0.000000	-1.000000
-0.309017	-0.951057
-0.587785	-0.809017
-0.809017	-0.587785
-0.951056	-0.309017
-1.000000	0.000000
-0.951056	0.309017
-0.809017	0.587785
-0.587785	0.809017
-0.309017	0.951057

The decimal values in SICO.TXT should be normalized such that they are in the between  $-1.0$  and  $+1.0$ . The waveform file SICO.WV will be based on the contents of this file.

To be read by the SMIQ these waveform data must be coded binary and packed into an appropriate WAVEFORM information unit.

The SMIQ recognizes a great variety of information units called tags. A tag consists of a name and a data set and is enclosed in curved brackets. The tag is a kind of label carrying the information what the SMIQ should do with the data set (see also section „ARB Waveform Format“ and step 3 of the following instructions).

The following steps outline how to create the waveform file SICO.WV:

**Step 1**

The values from the file SICO.TXT must be converted into binary format consisting of integer numbers without a sign a with 16-bit width. The numeric range between -1.0 and +1.0 corresponds to the modulation range of the waveform D/A converter of 64000.

+1.0 →	64768	}	
0.0 →	32768	}	64000
-1.0 →	768	}	

A further C-program is suitable for creating the binary data set from the ASCII values stored in SICO.TXT file (see following example for creating a C-program). This program stores the binary data set to a file called SICO.WV.

The contents of the file SICO.WV reads as follows:

```
IQIQIQIQIQIQI ... IQ
```

**Explanation:** *There is no readable representation for binary values in this document. This is why we use the sequence IQIQIQ to characterize the binary code in the present example.*

**Step 2**

The file SICO.WV contains now the binary data set corresponding to the 20 I/Q pairs. Before this binary data set can be further processed in step 3, the TYPE tag {TYPE: WV, xxxxxxxx} must be placed in front.

**The TYPE tag must be the first entry in a WAVEFORM.** The TYPE tag identifies the waveform as a valid SMIQ waveform.

**WV** denotes that the waveform is closed upon itself.

**xxxxxxx** is the checksum of the waveform. To simplify our example **0** is used, i.e., the SMIQ does not evaluate a checksum.

To enter the TYPE tag in the SICO.WV file an ASCII editor which is able to handle binary data as well, e.g. the Microsoft Windows editor **NOTEPAD** or **multi edit** from AMERICAN CYBERNETICS, must be used.

Now the contents of the SICO.WV file read:

```
{TYPE: WV, 0}
IQIQIQIQIQIQIQIQIQIQI ... IQ
```

**Step 3**

The binary data must now be packed into a WAVEFORM tag with the following structure:

```
{ WAVEFORM-Length:  $\bar{\alpha}\bar{0}$  Start, # I Q I Q I Q I Q I Q I Q I Q I Q I Q I Q ... I Q }
```

The WAVEFORM tag consists of the following characters and data:

{	Opens each tag.
<b>WAVEFORM</b>	Name of the tag for waveform.
-	Separates the name from the length indication.
<b>Length</b>	Length of the data set <b>Length</b> indicates the number of bytes of the data set and consists of: number of digits of the <b>Start</b> -value (1 to 7, in our example 1) + length of ",#" (2 bytes) + number of I/Q pairs * 4 (2 bytes for each I- and Q-value).
$\bar{\alpha}\bar{0}$	In our example containing a sine and a cosine with 20 pairs for each wave and with the start address 0 in the SMIQ's output memory, the resulting length is <b>83</b> .
:	Separates the name and length from the remainder of the data set. The blank $\bar{\alpha}\bar{0}$ can be omitted.
<b>Start</b>	Address in the output memory of the SMIQ used to store the following samples. In our example and most applications, this will be '0'.
,#	Indicates the beginning of the binary data.
<b>I Q I Q I Q</b>	Binary data set. The binary data contain the I and Q values in alternate order, the first value is an I value. Each value consists of 2 Bytes, starting with the least significant bit.
}	Terminates each tag.

The editor mentioned above which can handle binary data is now used to place the string "{ WAVEFORM-83:  $\bar{\alpha}\bar{0}$  ,#" in front and '}' at the end of the data set.

The contents of the waveform file SICO.WV for 20 I/Q pairs and start address 0 in the SMIQ's RAM is now ready for operation and reads.

```

{ TYPE: WV, 0 }           ┌────────── 20 I/Q pairs = 80 bytes ─────────┐
{ WAVEFORM-83:  $\bar{\alpha}\bar{0}$  ,# I Q I Q I Q I Q ... I Q }
└────────────────────────── 83 bytes ───────────────────────────┘
```

The tags TYPE and WAVEFORM are mandatory for each waveform. All other tags described in section „ARB Waveform Format“ are optional and can be inserted after the TYPE tag in arbitrary order, e.g.

```

{ TYPE: WV, 0 }
{ COMMENT: I/Q=sine/cosine, 20 points, clock 10 MHz }
{ CLOCK: 10e6 }
{ FILTER: 2,5MHz }
{ WAVEFORM-83:  $\bar{\alpha}\bar{0}$  ,# I Q I Q I Q I Q I Q ... I Q }
```



**C-program for creating the file SICO.TXT containing 20 sine and cosine pairs:**

```
#include <stdlib.h>
#include <stdio.h>
#include <math.h>

void main (void)
{
#define SAMPLES 20
int i;
float grad,rad;
FILE *logging_fp;

logging_fp = fopen("SICO.TXT", "w");

for (i = 0; i < SAMPLES; i++)
{
grad = (360.0 / (float)(SAMPLES)) * (float)i;
rad = grad * (3.141592654/180.0);
fprintf (logging_fp,"%f %f\n",sin(rad),cos(rad));
}
fclose(logging_fp);
}
```

Contents of the file  
SICO.TXT:

Sinus (I)	Cosinus (Q)
0.000000	1.000000
0.309017	0.951057
0.587785	0.809017
0.809017	0.587785
0.951057	0.309017
1.000000	-0.000000
0.951056	-0.309017
0.809017	-0.587785
0.587785	-0.809017
0.309017	-0.951056
-0.000000	-1.000000
-0.309017	-0.951057
-0.587785	-0.809017
-0.809017	-0.587785
-0.951056	-0.309017
-1.000000	0.000000
-0.951056	0.309017
-0.809017	0.587785
-0.587785	0.809017
-0.309017	0.951057

**Extract from a C-program generating a binary data set from the I/Q pairs in the file SICO.TXT and storing the result to file SICO.WV:**

```
:
FILE *fp_sour_i,*fp_sour_q,*fp_dest;
unsigned int i_uint, q_uint;
:
fp_sour = fopen("SICO.TXT", "rt" );
fp_dest = fopen("SICO.WV", "wb" );
:
while (1)
{
//Read I/Q pair from ASCII file
if (fscanf (fp_sour,"%f %f",&i_float, &q_float) == EOF)
break;

//Convert I/Q pair to unsigned integer
i_uint = (unsigned int)(32768.0 + (i_float*32000.0)+0.5);
i_uint &= 0xFFFC; //Mask marker bits
q_uint = (unsigned int)(32768.0 + (q_float*32000.0)+0.5);
q_uint &= 0xFFFC; //Mask marker bits

//Write converted I/Q pair to waveform file
fwrite (&i_uint,1,2,fp_dest);
fwrite (&q_uint,1,2,fp_dest);
}
:
```

### 3.5.4.3 Converting a Waveform with the Application Software AMIQ-K2

The application software AMIQ-K2 from R&S is distributed free of charge and allows to convert a large variety of I/Q data sets to SMIQ waveform. Moreover, AMIQ-K2 can be used to remote-control some important SMIQ functions, to load and to store waveforms.

This application software is available in the internet (<http://www.rsd.de>) under the path:

```
Products →
  Test and Measurement →
    Signal Generation →
      IQ modulation generator AMIQ →
or
  IQ simulation software WinIQSIM →
```

or from each R&S representative.

The control sequence

```
Select Source File(s)
Type   Mathcad (mixed)
Source File  SICO.TXT
Transmit
Destination
WV formatted SICO.WV
```

allows to quickly generate a waveform that is ready to operate from the file SICO.TXT containing the I/Q pairs in alternate order.

### 3.5.4.4 AMIQ Compatible Commands for Transmission and Administration of Waveforms

See AMIQ Operating Manual for a detailed description of the commands.

AMIQ command	Parameter	SMIQ command and Parameter
<b>:MMEMory</b>		<b>:ARB</b>
<b>:DATA</b>	'listname', <blockdata>	<b>:WAVEform:</b>
<b>:DATA?</b>	'listname', 'tagname' ⇒ tag	<b>DATA</b> 'listname', <blockdata>
<b>:DELeTe</b>	'listname'	<b>:DATA?</b> 'listname', 'tagname' ⇒ tag
<b>:CATalog?</b>	⇒ name[,name]...	<b>:DELeTe</b> 'listname'
<b>:LENGth?</b>	⇒ n	<b>:CATalog?</b> ⇒ name[,name]...
<b>:LOAD</b>	RAM, 'listname'	<b>LENGth?</b> ⇒ n
<b>:MEMory</b>		<b>:SELeCt</b> 'listname'
<b>:DATA?</b>	RAM, 'tagname' ⇒ tag	<b>:TAG?</b> 'tagname' ⇒ tag
<b>:NAME?</b>	⇒ listname	<b>:SELeCt?</b>

3.5.5 BERT System

Command	Parameter	Default Unit	Remark
<b>:BERT</b>			
<b>:STATe</b>	ON   OFF		
<b>:SEQuence</b>	AUTO   SINGle		
<b>:SETup</b>			
<b>:MCOunt</b>	1 to 4294967294		
<b>:MERRor</b>	1 to 4294967294		
<b>:TYPE</b>	PRBS9   PRBS11   PRBS15   PRBS16   PRBS20   PRBS21   PRBS23		
<b>:DATA</b>			
<b>[:POLarity]</b>	NORMal   INVerted		
<b>:CLOCK</b>			
<b>[:POLarity]</b>	RISing   FALLing		
<b>:REStart</b>	INTernal   EXTernal		
<b>:DENable</b>	OFF   LOW   HIGH		
<b>:MASK</b>	OFF   LOW   HIGH		Alias
<b>:IGNore</b>	OFF   ONE   ZERO		
<b>:UNIT</b>	SCientific   ENGIneering   PCT   PPM		
<b>:START</b>	(without)		
<b>:STOP</b>	(without)		
<b>:RESULT?</b>			Query only

**:BERT:STATe ON | OFF**

This command switches the bit error rate test on or off. The command `:BERT:START` sets the status internally to ON, while the command `:BERT:STOP` sets it to OFF.

Example: `:BERT:STAT ON` \*RST value is OFF

**:BERT:SEQuence AUTO | SINGle**

This command switches between continuous (AUTO) and single measurement (SINGle). A single measurement is terminated once the set number of data bits or error bits is reached. The continuous measurement is a sequence of automatically started single measurements.

By means of the command `:BERT:START`, the status is internally set to AUTO.

Example: `:BERT:SEQ SING` \*RST value is AUTO

**:BERT:SETup:MCOunt 1 to 4294967294**

This command sets the total number of data bits to be measured (data excluded by :BERT:SETup:DEnable do not count). When the internal data counter reaches or – in integrated BER test – exceeds this number, the single BER measurement is terminated. If this is followed by the query :BERT:RES?, the SMIQ signals with the fourth result that a BER measurement has been completed. This fourth result then has the value 1.

Valid value range: 1 to 4294967295 ( $2^{32}-1$ )

Example: :BERT:SET:MCO 1e6

\*RST value is 10.000.000

**:BERT:SETup:MERRor 1 to 4294967294.**

This command sets the number of error bits to be measured. When the internal bit error counter reaches or – in integrating BER test – exceeds this number, the SMIQ responds to a :BERT:RES? query by signalling with the fourth result = 1 that a single BER measurement has been terminated.

Valid value range: 1 to 4294967295 ( $2^{32}-1$ )

Example: :BERT:SET:MERR 100

\*RST value is 100

**:BERT:SETup:TYPE PRBS9 | PRBS11 | PRBS15 | PRBS16 | PRBS20 | PRBS21 | PRBS23**

With this command, various sequence lengths can be set for the pseudo-random bit sequence. The data generated by the PRBS generator are used as a reference.

Example: :BERT:SET:TYPE PRBS15

\*RST value is PRBS9

**:BERT:SETup:DATA[:POLarity] NORMal | INVerted**

This command defines the polarity of the external data signal.

NORMal: High level stands for a logic 1, low level for a logic 0.

INVerted: Low level stands for a logic 1, high level for a logic 0.

Example: :BERT:SET:DATA INV

\*RST value is NORM

**:BERT:SETup:CLOCK[:POLarity] RISing | FALLing**

This command defines which edge of the externally fed clock signal is active.

Example: :BERT:SET:CLOC FALL

\*RST value is RIS

**:BERT:SETup:REStart INTernal | EXTernal**

INTernal The reset signal for the BER test is generated internally by the program. This setting is suited for random sequences fitting cyclically into the SMIQ memory and therefore allowing an uninterrupted repetition of the random sequence.

EXTernal If the random sequence cannot be continued without interruption at memory wrap-around, the BER test has to be stopped in time and then restarted at the beginning of the data sequence. The measurement is stopped and started via a 0-1-0 edge at the restart input. Partial BER results (data and error bits) are added up until the predefined total number of data or error bits is reached or exceeded. These partial results are not affected by a restart.

Example: :BERT:SET:RES EXT

\*RST value is INT

**:BERT:SETup:DEnable OFF | LOW | HIGH**

The SMIQ has an input (data enable) allowing the temporary suspension of the BER test for processing data bursts or data interrupted by other data. This command configures this input.

- OFF Any signal applied to the input is ignored; all data are used for the BER measurement.
- HIGH If a high level signal is applied to the input, its data bits are counted and the bit errors detected and counted. If a low level signal is applied, the measurement is interrupted.
- LOW If a low level signal is applied to the input, its data bits are counted and the bit error detected and counted. If a high level signal is applied, the measurement is interrupted.

Example: `:BERT:SET:DEN HIGH` \*RST value is OFF

**:BERT:SETup:MASK OFF | LOW | HIGH**

This command is equivalent (alias) to the command `:BERT:SETup:DEnable` described above.

Example: `:BERT:SET:MASK HIGH` \*RST value is OFF

**:BERT:SETup:IGNore OFF | ONE | ZERO**

This command determines what to do with faulty data (frame errors) that were set to 0 or 1.

- OFF Pattern Ignore is not active.
- ONE Bit sequences consisting of 30 or more subsequent "1" data are not used (i.e. ignored) for the BER test.
- ZERO Bit sequences consisting of 30 or more subsequent "0" data are not used (i.e. ignored) for the BER measurement.

Example: `:BERT:SET:IGN ONE` \*RST value is OFF

**:BERT:UNIT SCLentific | ENGEineering | PCT | PPM**

This command sets the unit for displaying the error rate. It is only for display on SMIQ; it has no effect on results queried by `:BERT:RES?`.

Example: `:BERT:SET PCT` \*RST value is ENG

**:BERT:STARt**

This command starts a bit error rate test. The command `:BERT:STAT` is set to ON and `BERT:SEQ` to AUTO.

Example: `:BERT:STAR`

**:BERT:STOP**

The command stops an ongoing bit error rate test. If no measurement is in progress, this command has no effect. `:BERT:STAT` is set to OFF.

Example: `:BERT:STOP`

**:BERT:RESult?**

This query refers to the result of the most recent BER measurement. The response consists of seven results separated by commas. In the first measurement following the start, intermediate results for the number of data bits, error bits and error rate are also queried. In the following measurements (only for :BERT:SEQ AUTO), only the final results of each single measurement are queried.

Example: :BERT:RES?

Response: "10000,5,5E-4,1,1,1,1"

Result: 1,2,3,4,5,6,7

<b>Result 1</b>	Number of data bits in current query.
<b>Result 2</b>	Number of error bits in current query.
<b>Result 3</b>	Error rate. If no termination criterion has been reached since the beginning of the BER test, the current quotient of "Number of error bits" and "Number of data bits" is entered. As soon as at least one final result has been reached in continuous measurement, the most recent final result is entered. This means that the displayed error rate changes less rapidly.
<b>Result 4</b>	1 A BER measurement has been terminated, i.e. the number of data bits or error bits predefined by commands :BERT:SET MCOunt <n> or :BERT:SET MERRor <n> is reached, or the measurement was stopped by the command :BERT:STOP. 0 The BER measurement has not been terminated.
<b>Result 5</b>	1 Following the start of a BER measurement (by the command :BERT: START), an edge was detected on the clock line. 0 The clock line is not active.
<b>Result 6</b>	1 Following the start of a BER measurement (by the command :BERT: START), a data change edge was detected on the data line. This data change only refers to clocked data. If there is no clock, no data change is detected. 0 The data line is not active.
<b>Result 7</b>	1 The BER measurement is synchronized, i.e. both clock and data line are active and the "Number of error bits" to "Number of data bits" ratio is better than 0.1, so the measurement result can be assumed to be realistic. 0 The BER measurement is not synchronized.

## 3.5.6 BLER System

Command	Parameter	Default Unit	Remark
<b>:BLER</b>			
<b>:STATe</b>	ON   OFF		
<b>:SEQuence</b>	AUTO   SINGLe		
<b>:SETup</b>			
<b>:MCOunt</b>	1 to 4294967294		
<b>:MERRor</b>	1 to 4294967294		
<b>:TYPE?</b>	→ CRC16		Query only
<b>:DATA</b>			
<b>[:POLarity]</b>	NORMal   INVerted		
<b>:CLOCK</b>			
<b>[:POLarity]</b>	RISing   FALLing		
<b>:DENable</b>	LOW   HIGH		
<b>:UNIT</b>	SCientific   ENGineering   PCT   PPM		
<b>:START</b>	(without)		
<b>:STOP</b>	(without)		
<b>:RESULT?</b>			Query only

**:BLER:STATe ON | OFF**

This command switches the block error rate measurement on or off. The `:BLER:START` command sets the status internally to ON, while the `:BLER:STOP` command sets it to OFF.

Example: `:BLER:STAT ON`

\*RST value is OFF

**:BLER:SEQuence AUTO | SINGLe**

This command switches between continuous (`AUTO`) and single measurement (`SINGLe`). A single measurement is terminated once the set number of data blocks or the number of errors is reached. The continuous measurement is a sequence of automatically started single measurements.

Command `:BLER:START` sets the status internally to `AUTO`.

Example: `:BLER:SEQ SING`

\*RST value is `AUTO`

**:BLER:SETup:MCOunt 1 to 4294967294**

This command sets the total number of data blocks to be measured. The single BLER measurement is terminated when the internal data counter has reached this number. If this is followed by the query `:BLER:RES?`, the SMIQ signals with the fourth result that a BLER measurement has been completed. This fourth result has the value 1.

Valid value range : 1 to 4294967295 ( $2^{32}-1$ )

Example: `:BLER:SET:MCO 1e6`

\*RST value is 10 000 000

**:BLER:SETup:MERRor 1 to 4294967294**

This command sets the number of errors to be measured. When the internal block error counter reaches this number, the SMIQ responds to a `:BLER:RES?` query by signalling with the fourth result = 1 that a single BLER measurement has been terminated.

Valid value range: 1 to 4294967295 ( $2^{32}-1$ )

Example: `:BLER:SET:MERR 100`

\*RST value is 100

#### **:BLER:SETup:TYPE?**

With this command the type of measurement can be queried. At present, only CRC16 is possible.

Example: `:BLER:SET:TYPE?`

\*RST value is CRC16

#### **:BLER:SETup:DATA[:POLarity] NORMal | INVerted**

This command defines the polarity of the external data signal.

NORMal: High level corresponds to logic 1, low level to logic 0.

INVerted: Low level corresponds to logic 1, high level to logic 0.

Example: `:BLER:SET:DATA INV`

\*RST value is NORM

#### **:BLER:SETup:CLOCK[:POLarity] RISing | FALLing**

This command defines which edge of the external clock signal is active.

Example: `:BLER:SET:CLOC FALL`

\*RST value is RIS

#### **:BLER:SETup:DENable LOW | HIGH**

The SMIQ is equipped with an input (Data Enable) that allows the data stream to be masked. This command configures this input.

HIGH The bits applied at high level of the Data Enable signal are interpreted as information bits. At low level they are interpreted as checksum bits.

LOW The bits applied at low level of the Data Enable signal are interpreted as information bits. At high level they are interpreted as checksum bits.

Example: `:BLER:SET:DEN HIGH`

\*RST value is LOW

#### **:BLER:UNIT SCientific | ENGineering | PCT | PPM**

This command sets the unit for error rate display. It is only valid for display on SMIQ and has no effect on the results queried by `:BLER:RES?`.

Example: `:BLER:SET PCT`

\*RST value is ENG

#### **:BLER:STARt**

This command starts a block error rate measurement. The `:BLER:STAT` command is set to ON, command `BLER:SEQ` to AUTO.

Example: `:BLER:STAR`

#### **:BLER:STOP**

The command stops an ongoing block error rate measurements. If no measurement is in progress, this command has no effect. The command `:BLER:STAT` is set to OFF.

Example: `:BLER:STOP`



**:BLER:RESult?**

This command queries the result of the most recent BLER measurement.

The response consists of seven values separated by commas. In the first measurement after the start, intermediate results are also queried for the number of data blocks, errors and error rate. In the subsequent measurements (only `:BLER:SEQ AUTO`), only the final results of the single measurements are queried.

Example: `:BLER:RES?`

Response: "10000,5,5E-4,1,1,1,1"

Value            1    , 2,   3    , 4, 5, 6, 7

<b>Value 1</b>	Number of data blocks in current query.
<b>Value 2</b>	Number of errors in current query.
<b>Value 3</b>	Error rate: If no termination criterion has been reached since the beginning of the BLER measurement, the current quotient of "Number of errors" and "Number of data blocks" is entered. As soon as at least one final result has been reached in a continuous measurement, the most recent final result is entered. This means that the displayed error rate changes less quickly.
<b>Value 4</b>	1 A BLER measurement has been terminated, i.e. the number of data blocks or errors predefined by the <code>:BLER:SET MCOunt &lt;n&gt;</code> or <code>:BLER:SET MERRor &lt;n&gt;</code> command is reached, or the BLER measurement was stopped by command <code>:BLER:STOP</code> . 0 The BLER measurement has not been terminated.
<b>Value 5</b>	1 After the start of a BLER measurement (command <code>:BLER: START</code> ), an edge was detected on the clock line. 0 The clock line is not active.
<b>Value 6</b>	1 After the start of a BLER measurement (command <code>:BLER:START</code> ), a data change edge was detected on the data line. This data change only affects the clocked data. If there is no clock, no data change is detected. 0 The data line is not active.
<b>Value 7</b>	1 The BLER measurement is synchronized, i.e. the clock and data line are active and the "Number of errors" to "Number of data blocks" ratio is better than 0.1, so that the measurement result can be assumed to be realistic. 0 The BLER measurement is not synchronized.

### 3.5.7 CALibration System

The CALibration system contains the commands to calibrate the SMIQ. On triggering the calibration by means of :MEASure, response "0" displays a faultless calibration, response "1" means that an error has occurred during calibration. As to the meaning of the data in the case of query :DATA?, cf. Chapter 2, Section "Calibration".

Command	Parameter	Default Unit	Remark
:CALibration			
:ALL			
:FSIM [MEASure]?			Query only
:LATTenuation [:MEASure]?			Query only
:LEVel :DATA? :STATe	ON   OFF		Query only
:LPReset [:MEASure]?			Query only
:DATA?			Query only
:NDSim [:MEASure]?			Query only
:ROSCillator [:DATA]	0 to 4095		
:VSUMmation [:MEASure]?			Query only
:OFFS?			Query only
:DAC?			Query only
:KOS?			Query only
:VMOdulation [:MEASure]?			Query only
:LFGenerator [:MEASure]?			Query only

#### :CALibration[:ALL]?

This command triggers all internal calibrations which do not require any external measuring equipment. The command triggers an event and thus has no \*RST value.

Example: :CAL:ALL?

#### :CALibration:FSIM[:MEASure]?

The command triggers a calibration measurement of the DC offset of the fading simulator. The command triggers an event and thus has no \*RST value.

Example: :CAL:FSIM?

#### :CALibration:LATTenuation[:MEASure]?

The command triggers a calibration measurement of the level attenuation of function envelope control. The command triggers an event and thus has no \*RST value.

Example: :CAL:LPR:MEAS?

Response: 0

**:CALibration:LEVel**

This node provides the commands for the management of the level correction table. The corresponding data are permanently stored in the instrument and cannot be changed. The instrument includes different level correction tables. The tables to be used are selected depending on the set frequency and modulation type. The `:STATe ON` command activates the level correction table corresponding to the instrument setup.

**:CALibration:LEVel:DATA?**

The command queries the level correction data. It returns all level correction data in the format fixed in the `:FORMat` system.

Example: `:CAL:LEV:DATA?`

**:CALibration:LEVel:STATe ON | OFF**

The command switches on or off internal level correction.

\*RST value is ON

Example: `:CAL:LEV:STAT OFF`

**:CALibration:LPReset**

The commands to measure the values for the level presetting table are under this node (Level PReset).

**:CALibration:LPReset[:MEASure]?**

The command triggers a calibration measurement. The command triggers an event and thus has no \*RST value.

Example: `:CAL:LPR:MEAS?`

Response: 0

**:CALibration:LPReset:DATA?**

The command queries the correction data. It returns all correction data in the format fixed in the `:FORMat` system.

Example: `:CAL:LPR:DATA?`

**:CALibration:NDSim[:MEASure]?**

This command triggers an offset calibration of module NDSIM.

Example: `:CAL:NDS?`

Answer: 0 if OK, 1 if faulty

**:CALibration:ROSCillator**

The commands to calibrate the reference oscillator are under this node.

**:CALibration:ROSCillator[:DATA] 0 to 4095**

The command enters the correction data. For an exact definition of the calibration value, cf. Section 2.

Example: `:CAL:ROSC:DATA 2048`

**:CALibration:VSUMmation**

The commands to determine the support values for the frequency setting are under this node.

**:CALibration:VSUMmation [:MEASure]?**

The command triggers a calibration measurement. The command triggers an event and thus has no \*RST value.

Example: :CAL:VSUM:MEAS?

Answer: 0

**:CALibration:VSUMmation:OFFS?****:CALibration:VSUMmation:DAC?****:CALibration:VSUMmation:KOS?**

The commands query the calibration data (see service manual). they return all correction data in the format fixed in the :FORMat system.

Example: :CAL:VSUM:OFFS?

**:CALibration:VMODulation[:MEASure]?**

This command triggers a calibration measurement for the vector modulation. Since it triggers an event it has no default setting value.

Example: :CAL:VMOD:MEAS?

Answer: 0

**:CALibration:LFGenerator[:MEASure]?**

This command triggers a calibration measurement for the LF generator. Since it triggers an event it has no default setting value.

Example: :CAL:LFG:MEAS?

Answer: 0



**:DIAGnostic:DLISt:CHECksum:CALculate**

This command calculates the checksum of the currently selected control list (see Digital Modulation DLISt).

Example: :DIAG:DLIS:CHEC:CALC

**:DIAGnostic:DLISt:CHECksum:DATA?**

This command displays the checksum calculated before in hexadecimal representation (see above).

Example: :DIAG:DLIS:CHEC:DATA? Response:1234567

**:DIAGnostic:INFO**

The commands which can be used to query all information which does not require hardware measurement are under this node.

**:DIAGnostic:INFO:CCOunt**

The commands which can be used to query all counters in the instrument are under this node (Cycle COunt).

**:DIAGnostic:INFO:CCOunt:ATTenuator 1 | 2 | 3 | 4 | 5 | 6?**

The command queries the number of switching processes of the different attenuator stages. The stages are designated with Z1 to Z6 within the instrument. In this command they are differentiated by a numeric suffix whose name corresponds to the number:

Suffix	Name	Function
1	Z1	40-dB stage
2	Z2	20-dB stage
3	Z3	5-dB stage
4	Z4	20-dB stage
5	Z5	10-dB stage
6	Z6	40-dB stage

Example: :DIAG:INFO:CCO:ATT1? Response: 1487

**:DIAGnostic:INFO:CCOunt:POWER?**

The command queries the number of switch-on processes.

Example: :DIAG:INFO:CCO:POW? Response: 258

**:DIAGnostic:INFO:MODules?**

The command queries the modules existing in the instrument with their model and state-of-modification numbers. The response supplied is a list in which the different entries are separated by commas. The length of the list is variable and depends on the equipment of the instrument. Each entry consists of three parts which are separated by means of blanks:

1. Name of module;
2. Variant of module in the form VarXX (XX = 2 digits)
3. Revision of module in the form RevXX (XX = 2 digits)

Example :DIAG:INFO:MOD? Response: FRO Var01 Rev00, DSYN Var03 Rev12, to...

**:DIAGnostic:INFO:OTIME?**

The command reads out the internal operating-hours counter. The response supplies the number of hours the instrument has been in operation up to now.

Example: :DIAG:INFO:OTIM? Response: 19

**:DIAGnostic:INFO:SDATE?**

The command queries the date of software creation. The response is returned in the form month, day, year.

Example: :DIAG:INFO:SDAT? Response: Dec 15 1998

**:DIAGnostic[:MEASure]**

The commands which trigger a measurement in the instrument and return the measured value are under this node.

**:DIAGnostic[:MEASure]:POINT?**

The command triggers a measurement at a measuring point and returns the voltage measured. The measuring point is specified by a numeric suffix (cf. service manual, stock no. 1125.5610.24).

Example: :DIAG:MEAS:POIN2? Response: 3.52

### 3.5.9 DISPLAY System

This system contains the commands to configure the screen. If system security is activated using command `SYSTEM:SECURITY ON`, the display cannot be switched on and off arbitrarily (cf. below)

Command	Parameter	Default Unit	Remark
<code>:DISPlay</code> <code>:ANNotation</code> <code>[:ALL]</code> <code>:AMPLitude</code> <code>:FREQuency</code>	ON   OFF ON   OFF ON   OFF		

#### `:DISPlay:ANNotation`

The commands determining whether frequency and amplitude are indicated under this node.

**Caution:** *With `SYSTEM:SECURITY ON`, the indications cannot be switched from OFF to ON. In this case `*RST` does not influence the ANNotation settings either. With `SYSTEM:SECURITY OFF`, the `*RST` value is ON for all ANNotation parameters.*

#### `:DISPlay:ANNotation[:ALL] ON | OFF`

The command switches the frequency and amplitude indication on or off.

Command `:DISPlay:ANNotation:ALL ON` can only be executed if `SYSTEM:SECURITY` is set to OFF.

Example: `:DISP:ANN:ALL ON` With `SECURITY OFF` - `*RST` value is ON

#### `:DISPlay:ANNotation:AMPLitude ON | OFF`

The command switches on or off the amplitude indication.

Command `:DISPlay:ANNotation:AMPLitude ON` can only be executed if `SYSTEM:SECURITY` is set to OFF.

Example: `:DISP:ANN:AMPL ON` With `SYSTEM:SECURITY OFF` - `*RST` value is ON

#### `:DISPlay:ANNotation:FREQuency ON | OFF`

The command switches on or off the frequency indication.

Command `:DISPlay:ANNotation:FREQuency ON` can only be executed if `SYSTEM:SECURITY` is set to OFF.

Example: `:DISP:ANN:FREQ ON` With `SYSTEM:SECURITY OFF` - `*RST` value is ON



### 3.5.10 FORMat System

This system contains the commands determining the format of the data the SMIQ returns to the controller. All queries returning a list of numeric data or block data are concerned. With each of these commands, this connection is pointed to in the description.

Command	Parameter	Default Unit	Remark
:FORMat [:DATA] :BORDER	ASCii   PACKed NORMal   SWAPPed		

#### :FORMat[:DATA] ASCii | PACKed

The command specifies the data format, that the SMIQ uses for returning the data. When data are transmitted from the controller to the SMIQ, the SMIQ recognizes the data format automatically. In this case, the value specified here has no significance.

**Note:** Settings using the FORMat:DATA command are only effective for commands with which this is stated in the command description.

ASCii Numeric data are transmitted in plain text, separated by commas.

PACKed Numerical data are transmitted as binary block data. The format of the binary data itself is command-specific. Its description can be found in Section 3.4.5.

Example: :FORM:DATA ASC \*RST value is ASCii

#### :FORMat:BORDER NORMal | SWAPPed

This command defines the order of bytes inside a binary block. This concerns only blocks which use the IEEE754 format internally (see section 3.4.5, paragraph "Block Data").

NORMal: The SMIQ expects (for setting commands) and sends (for queries) first the most significant byte of each IEEE-754 floating point number, last the least significant byte. For hosts based on a 80x86 processor this corresponds to the configuration of bytes in the main memory. Thus, no further conversion is required.

SWAPPed: The SMIQ expects (for setting commands) and sends (for queries) first the least significant byte of each IEEE754 floating point number, last the most significant byte.

Example: :FORMat:BORDER:NORMal \*RST value is NORMal

### 3.5.11 MEMory System

This system contains the commands for the memory management of the SMIQ.

Command	Parameter	Default Unit	Remark
:MEMory :NSTates?			Query only

#### :MEMory:NStates?

The command returns the number of \*SAV/\*RCL memories available. The SMIQ has 50 \*SAV/\*RCL memories in total.

Example: :MEM:NST?

Response: 50

### 3.5.12 OUTPut System

This system contains the commands specifying the characteristics of the RF output socket and the BLANK socket. The characteristics of the LF socket are specified in the OUTPut2 system.

Command	Parameter	Default Unit	Remark
<b>:OUTPut</b>			
<b>:AMODE</b>	AUTO   FIXEd   ELECtronic		
<b>:AFIXEd</b>			
<b>:RANGe</b>			
<b>:UPPer?</b>			Query only
<b>:LOWer?</b>			Query only
<b>:BLANK</b>			
<b>:POLarity</b>	NORMal   INVerted		
<b>:IMPedance?</b>			Query only
<b>:PROTection</b>			
<b>:CLEar</b>			
<b>:TRIPped?</b>			Query only
<b>[:STATe]</b>	ON   OFF		
<b>:PON</b>	OFF   UNCHanged		

**:OUTPut:AMODE** AUTO | FIXEd | ELECtronic

The command switches over the operating mode of the attenuator at the RF output (Attenuator MODE).

AUTO The attenuator is switched whenever possible.

FIXEd The attenuator is switched when certain fixed levels are exceeded/fallen below.

ELECtronic The level is additionally (without modifying the attenuator) changed via the IQ modulator.

Example: :OUTP:AMOD AUTO \*RST value is AUTO

**:OUTPut:AFIXEd:RANGe:UPPer?**

This command queries the maximum level which can be set without modifying the attenuator (Attenuator FIXEd).

Example: :OUTP:AFIX:RANG:UPP? Response: -27

**:OUTPut:AFIXEd:RANGe:LOWer?**

This command queries the minimum level which can be set without modifying the attenuator (Attenuator FIXEd).

Example: :OUTP:AFIX:RANG:UPP? Response: -50

**:OUTPut:BLANK:POLarity** NORMal | INVerted

The command sets the polarity of the BLANK signal.

NORMal The active BLANK state is indicated by the more positive or higher output voltage.

INVers The active BLANK state is indicated by the more negative or lower output voltage.

Example: :OUTP:BLAN:POL NORM RST value is NORM

**:OUTPut:IMPedance?**

The command queries the impedance of the RF output. This permits converting the output level between units V and W. The impedances cannot be changed. With the SMIQ, this is the fixed value of 50 Ohm for the RF output.

Example: :OUTP:IMP? Response: 50

**:OUTPut:PROTection**

The commands to configure the protective circuit are under this node. The RF output is protected by a protective circuit which deactivates the output if an overvoltage is supplied from outside. This does not change the value of `OUTPut:STATe`.

**:OUTPut:PROTection:CLEar**

The command resets the protective circuit after it has been triggered. The state of the output is determined by `OUTPut:STATe` again. The command triggers an event and hence has no default setting value.

Example: :OUTP:PROT:CLE

**:OUTPut:PROTection:TRIPped?**

The command queries the state of the protective circuit. The responses mean:

"0" The protective circuit has not responded

"1" The protective circuit has responded

Example: :OUTP:PROT:TRIP? Response: "1"

**:OUTPut[:STATe]** ON | OFF

The command switches on or off the RF output. The RF output can also be switched off by the response of the protective circuit. But this has no influence on this parameter.

**Note:** *In contrast to the PRESET key, command \*RST sets this value to OFF, the output is deactivated.*

Example: :OUTP:STAT ON \*RST value is OFF

**:OUTPut[:STATe]:PON** OFF | UNCHanged

This command selects the state the RF output is to assume after power-on of the unit. It only exists for the RF output. \*RST does not influence the set value.

OFF Output is switched off.

UNCHanged Same state as before switch- off

Example: :OUTP:PON OFF

**3.5.13 OUTPut2 System**

This system contains the commands specifying the characteristics of the LF output socket.

Command	Parameter	Default Unit	Remark
:OUTPut2 [:STATe] :VOLTage	ON   OFF 0 V to 4 V	V	

**:OUTPut2[:STATe] ON | OFF**

The command switches the LF output on or off.

\*RST value is OFF

Example: :OUTP2:STAT ON

**:OUTPut2:VOLTage 0V to 4V**

The command sets the voltage of the LF output.

\*RST value is 1 V

Example: :OUTP2:VOLT 3.0V

### 3.5.14 SOURce System

This system contains the commands to configure the RF signal source. Keyword SOURce is optional, i.e., it can be omitted. The LF signal source is configured in the SOURce2 system.

The following subsystems are realized in the instrument:

Subsystem	Settings
<b>[:SOURce]</b>	
<b>:AM</b>	Amplitude modulation
<b>:CORRection</b>	Correction of the output level
<b>:DECT</b>	Digital standard DECT
<b>:DIST</b>	Distortion simulation
<b>:DM</b>	I/Q and digital standard modulations
<b>:FM</b>	Frequency modulation
<b>:FREQuency</b>	Frequencies including sweep
<b>:FSIM</b>	Fading simulator
<b>:GSM/EDGE</b>	Digital standard GSM/EDGE
<b>:IS95</b>	Digital standard IS-95 CDMA
<b>:LIST</b>	LIST mode
<b>:MARKer</b>	Marker generation with sweeps
<b>:MODulation</b>	Switching on/off of all modulations
<b>:NADC</b>	Digital standard NADC
<b>:NOISe</b>	Noise generation
<b>:PDC</b>	Digital standard PDC
<b>:PHASe</b>	Phase between output signal and reference oscillator signal
<b>:PHS</b>	Digital standard PHS
<b>:PM</b>	Phase modulation
<b>:POWer</b>	Output level, level control and level correction
<b>:PULM</b>	Pulse modulation
<b>:ROSCillator</b>	Reference oscillator
<b>:SWEep</b>	Sweeps
<b>:WCDMa</b>	Digital standard W-CDMA
<b>:W3GPP</b>	Digital standard 3GPP W-CDMA

**3.5.14.1 SOURce:AM Subsystem**

This subsystem contains the commands to control the amplitude modulation. Part if the LF-generator settings is effected under SOURce2.

Command	Parameter	Default Unit	Remark
[:SOURce] :AM :BBANd [:STATe] [:DEPTH] :EXTernal :COUPling :INTernal1 2 :FREQUency :SOURce :STATe	ON   OFF 0 to 100 PCT AC   DC 0.1 Hz to 1 MHz EXT   INT   EXT, INT ON   OFF	PCT   Hz	

**[:SOURce]:AM:BBANd[:STATe] ON | OFF**

The command switches on or off the BB-AM (through the I-input of the IQ-modulator).  
Example: :SOUR:AM:BBAN:STAT ON \*RST value is OFF

**[:SOURce]:AM[:DEPTH] 0 to 100PCT**

The command sets the modulation depth in percent.  
Example: :SOUR:AM:DEPT 15PCT \*RST value is 30PCT

**[:SOURce]:AM:EXTernal:COUPling AC | DC**

The command selects the type of coupling for the external AM input.  
AC The d.c. voltage content is separated from the modulation signal.  
DC The modulation signal is not altered.  
Example: :SOUR:AM:EXT:COUP AC \*RST value is AC

**[:SOURce]:AM:INTernal**

The settings for the internal AM inputs (LF generator) are effected under this node. Here the same hardware is set for AM, PM, FM and SOURce2. This means that, for example, the following commands are coupled with each other and have the same effect:  
:SOUR:FM:INT:FREQ; :SOUR:PM:INT:FREQ; :SOUR2:FREQ: CW

**[:SOURce]:AM:INTernal1|2:FREQUency**

The command sets the modulation frequency. 0.1 Hz to 1MHz  
Example: :SOUR:AM:INT:FREQ 15kHz \*RST value is 1 kHz

**[:SOURce]:AM:SOURce EXT | INT|EXT, INT**

The command selects the modulation source. INT is the internal LF generator. The external and the internal modulation source can be indicated at the same time (see example).  
Example: :SOUR:AM:SOUR INT, EXT \*RST value is INT

**[:SOURce]:AM:STATe ON | OFF**

The command switches amplitude modulation on or off.  
Example: :SOUR:AM:STAT ON \*RST value is OFF

### 3.5.14.2 SOURce:CORRection Subsystem

The CORRection subsystem permits a correction of the output level. The correction is effected by adding user-defined table values to the output level as a function of the RF frequency. In the SMIQ, this subsystem serves to select, transmit and switch on USER-CORRECTION tables (see Chapter 2, Section "User Correction (UCOR)" as well).

Command	Parameter	Default Unit	Remark
<b>[[:SOURce]</b> <b>:CORRection</b> <b>[[:STATe]</b> <b>:CSET</b> <b>:CATalog?</b> <b>[[:SElect]</b> <b>:DATA</b> <b>:FREquency</b> <b>:POWer</b> <b>:DELete</b>	ON   OFF  ⇒ name {,name}... "Name of table"  300 kHz to RF <sub>max</sub> {,300 kHz to RF <sub>max</sub> } -40 dBto 6dB {,-40 dBto 6dB} "Name of table"	     Hz dB	  Query only  RF <sub>max</sub> depending on model  no query

#### **[[:SOURce]:CORRection[:STATe] ON | OFF**

The command switches the table selected using SOURce:CORRection:CSET on or off.

Example: :SOUR:CORR:STAT ON

\*RST value is OFF

#### **[[:SOURce]:CORRection:CSET**

The commands to select and edit the UCOR tables are under this node.

#### **[[:SOURce]:CORRection:CSET:CATalog?**

The command requests a list of UCOR tables. The individual lists are separated by means of commas. This command is a query and has no \*RST value.

Example: :SOUR:CORR:CAT?

Answer: "UCOR1", "UCOR2", "UCOR3"

#### **[[:SOURce]:CORRection:CSET[:SElect] "Name of table"**

The command selects a UCOR table. This command alone does not yet effect a correction. First the table selected must be activated (cf. :SOURce:CORRection:STATe). If there is no table of this name, a new table is created. The name may contain up to 7 letters. This command triggers an event and hence has no \*RST value.

Example: :SOUR:CORR:CSET:SEL "UCOR1"

#### **[[:SOURce]:CORRection:CSET:DATA**

The commands to edit the UCOR tables are under this node.

#### **[[:SOURce]:CORRection:CSET:DATA:FREquency** 300 kHz to RF<sub>max</sub> {,300 kHz to RF<sub>max</sub> } (RF<sub>max</sub> depending on model)

The command transmits the frequency data for the table selected using :SOURce:CORRection:CSET. \*RST does not influence data lists.

Example: :SOUR:CORR:CSET:DATA:FREQ 100MHz,102MHz,103MHz,to



**[:SOURce]:CORRection:CSET:DATA:POWer** -40dB to 6dB {,-40dB to 6dB}

The command transmits the level data for the table selected using :SOURce:CORRection:CSET. \*RST does not influence data lists.

Example: :SOUR:CORR:CSET:DATA:POWer 1dB, 0.8dB, 0.75dB, to

**[:SOURce]:CORRection:CSET:DELeTe** "Name of table"

The command deletes the table indicated from the instrument memory. This command triggers an event and hence has no \*RST value.

Example: :SOUR:CORR:CSET:DEL "UCOR2"

## 3.5.14.3 SOURce:DECT Subsystem

**Note** #B0 to #BF are characters which are entered in binary form manually. SCPI (and IEEE 488.2) also accept the entry of non-decimal characters in octal and hexadecimal such as #H|h <0 to 9, A|a to F|f>, #Q|q <0 to 7> and #B|b <0|1>. The characters are always output in Hex format after a query.

Command	Parameter	Default Unit	Remark
[:SOURce]			
:DECT			
:STATe	ON   OFF		
:STANdard			
:FORMat	GFSK   P4DQpsk		
:FSK			
:DEVIation	100Hz to 1.2MHz	HZ	range 0.1 to 1 × symbol rate
:SRATe	2k to 1.2M / 1k to 0.6M Hz (GFSK/P4DQ)	Hz	
:FILTer			
:TYPE	GAUSs   SCOSine   COSine   USER		
:SElect	'name'		
:PARAmeter	0.2 to 0.7		
:SEQuence	AUTO   RETRigger   AAUTO   ARETrigger		
:TRIGger			
:SOURce	EXTernal   INTernal		
:INHibit	0 to 67.1E6		
:DELay	0 to 65535		
:OUTPut[2]	SLOT   FRAMe		
:DELay	0 to 11519		
:PERiod	1 to 67.1E6		
:CLOCK			
:SOURce	INTernal   EXTernal		
:DELay	0 to 1.0		
:PRAMp			
:PRESet			
:TIME	0.25 to 16		no query
:DELay	-1.0 to +1.0		
:SHAPE	LINear   COSine		
:ROFFset	-9 to +9		
:FOFFset	-9 to +9		
:SLOT			
:ATTenuation	0 to 70 dB	DB	
:SIMulation			
:TADJustment	-4 to +4 (symbol)		
:JITTer	0 to 4 (symbol)		



**[[:SOURce]:DECT:FORMat GFSK | P4DQpsk**

The command selects the type of modulation.

Example: `:SOUR:DECT:FORM P4DQ`

\*RST value is GFSK

**[[:SOURce]:DECT:FSK:DEVIation 1kHz to 1.2 MHz**

The command sets the modulation depth (only for `DECT:FORMat GFSK`). The range of values depends on the symbol rate (`DECT:SRATe × 0.1` to 1).

Example: `:SOUR:DECT:FSK:DEV 300.6kHz`

\*RST value is 288kHz

**[[:SOURce]:DECT:SRATe 1 kHz to 1.2 MHz**

The command sets the symbol rate. Permissible values for `GFSK` are 2 kHz to 1.2 MHz and 1 kHz to 0.6 MHz for `P4DQpsk`.

Example: `:SOUR:DECT:SRAT 192.1 kHz`

\*RST value is 1152/576kHz (GFSK/P4DQ)

**[[:SOURce]:DECT:FILTer**

The commands for selecting a filter are under this node.

**[[:SOURce]:DECT:FILTer:TYPE GAUSs | SCOSine | COSine USER**

The command selects the type of filter; `SCOS` and `COS` can be set for `P4DQpsk`. For `DECT:FORMat GFSK`, the `GAUSs` type is set automatically. A filter list should be selected with `:DECT:FILT:SEL 'name'` for the filter type `USER`.

Example: `:SOUR:DECT:FILT:TYPE COS`

\*RST value is GAUS/SCOS (GFSK/P4DQ)

**[[:SOURce]:DECT:FILTer:SELEct 'name'**

The command selects a named filter list. The list is used only if a user-defined filter is selected with `:DECT:FILT:TYPE USER`. To generate lists, cf. command `[[:SOURce]:DM:FLISt:SEL`, to fill up lists, cf. command `[[:SOURce]:DM:FLISt:DATA`.

Example: `:SOUR:DECT:FILT:SEL 'test'`

\*RST value is NONE

**[[:SOURce]:DECT:FILTer:PARAmeter 0.2 to 0.7**

The command sets the filter parameter.

Example: `:SOUR:DECT:FILT:PAR 0.2`

\*RST value is 0.5

**[[:SOURce]:DECT:SEQuence AUTO | RETRigger | AAUTo | ARETrigger**

The command selects the trigger mode for the sequence.

AAUTo            ARMED AUTO

ARETrigger      ARMED RETRIG

Example: `:SOUR:DECT:SEQ AAUT`

\*RST value is AUTO

**[[:SOURce]:DECT:TRIGger:SOURce EXTernal | INTernal**

The command selects the trigger source. With `INT` selected, triggering is via IEC/IEEE bus or the Execute command in manual control.

Example: `:SOUR:DECT:TRIG:SOUR EXT`

\*RST value is INT

**[[:SOURce]:DECT:TRIGger:INHibit 0 to 67.1E6**

The command sets the retrigger inhibit duration (in number of symbols).

Example: `:SOUR:DECT:TRIG:INH 1000` \*RST value is 0

**[[:SOURce]:DECT:TRIGger:DELay 0 to 65535**

The command sets the trigger delay (in number of symbols).

Example: `:SOUR:DECT:TRIG:DEL 200` \*RST value is 0

**[[:SOURce]:DECT:TRIGger:OUTPut[1|2]:DELay 0 to 11519**

The command determines the delay of the signal at trigger output 1 or 2 in comparison with the start of the frames/slots in number of symbols.

Example: `:SOUR:DECT:TRIG:OUTP2:DEL 16` \*RST value is 0

**[[:SOURce]:DECT:TRIGger:OUTPut[2]:PERiod 1 to 67.1E6**

The command sets the repeat rate (in number of frames) of the signal at trigger output 2.

Example: `:SOUR:DECT:TRIG:OUTP2:PER 8` \*RST value is 1

**[[:SOURce]:DECT:CLOCK**

The commands for setting the data clock are under this node.

**[[:SOURce]:DECT:CLOCK:SOURce INTERNAL | EXTERNAL**

The command selects the source for the DM data clock.

INTERNAL The internal clock generator is used and output via the clock outputs of the serial and parallel interface.

EXTERNAL The clock is externally fed in via the serial interface and output via the parallel interface.

Example: `:SOUR:DECT:CLOC:SOUR INT` \*RST value is INT

**[[:SOURce]:DECT:CLOCK:DELay 0 to 1.0**

The command sets the delay of the symbol clock (as a fraction of the length of a symbol).

Example: `:SOUR:DECT:CLOC:DEL 0.75` \*RST value is 0

**[[:SOURce]:DECT:PRAMP**

The commands for the level control of the burst are under this node.

**[[:SOURce]:DECT:PRAMP:PRESet**

This command sets the standard-stipulated values for the following commands of level control. It is an event and hence has no query and no \*RST value.

Example: `:SOUR:DECT:PRAM:PRES`

**[[:SOURce]:DECT:PRAMP:TIME 0.25 to 16.0**

The command sets the cutoff steepness (in symbol clocks).

Example: `:SOUR:DECT:PRAM:TIME 2.5` \*RST value is 2

**[[:SOURCE]:DECT:PRAMP:DELay -1.0 to +1.0**

The command defines the shift of the envelope characteristic to the modulated signal. A positive value causes a delay of the envelope.

Example: `:SOUR:DECT:PRAM:DEL 0.2` \*RST value is 0

**[[:SOURCE]:DECT:PRAMP:SHAPE LINear | COSine**

The command selects the linear or cosine shape of the ramp-up and ramp-down (power burst).

Example: `:SOUR:DECT:PRAM:SHAP LIN` \*RST value is COS

**[[:SOURCE]:DECT:PRAMP:ROFFset -9 to +9**

The command determines the timing of the ('R'ising) edge of a power burst to the beginning of the slot.

Example: `:SOUR:DECT:PRAM:ROFF -3` \*RST value is 0

**[[:SOURCE]:DECT:PRAMP:FOFFset -9 to +9**

The command determines the timing of the ('F'alling) edge of a power burst to the data block.

Example: `:SOUR:DECT:PRAM:FOFF 4` \*RST value is 0

**[[:SOURCE]:DECT:SLOT:ATTenuation 0 to 70 dB**

The command determines the amount by which the power of the slots marked by `:DECT:SLOT:LEVEL ATT` is reduced in comparison with the normal output power (attribute to `:LEVEL FULL`).

Example: `:SOUR:DECT:SLOT:ATT 20 dB` \*RST value is 0

**[[:SOURCE]:DECT:SIMulation:TADJustment -4 to +4 (in symbols)**

This command simulates the timing adjust by extending every 35th frame by the set number of symbols (positive) or by reducing it (negative). 0 is off.

Example: `:SOUR:DECT:SIM:TADJ 3` \*RST value is 0

**[[:SOURCE]:DECT:SIMulation:JITTer 0 to 4 (in symbols)**

This command simulates the jitter by advancing even frames by the set number of symbols and by delaying uneven frames. 0 is off.

Example: `:SOUR:DECT:SIM:JITT 2` \*RST value is 0

**[[:SOURCE]:DECT:FLISt**

The commands for storing and reading complete frames including their bursts (slots) are under this node. Predefined and user-generated frames have to be distinguished.

**[[:SOURCE]:DECT:FLISt:PREDefined:CATalog?**

The command returns a list of all predefined frames.

Example: `:SOUR:DECT:FLIS:PRED:CAT?`

**[[:SOURCE]:DECT:FLISt:PREDefined:LOAD 'name'**

The command selects one of the predefined (fixed) frames (c.f. Chapter 2). This command triggers an event and hence has no \*RST value.

Example: `:SOUR:DECT:FLIS:PRED:LOAD 'test'`

**[:SOURce]:DECT:FLIS:CATalog?**

The command returns a list of all user-defined frames.

Example: `:SOUR:DECT:FLIS:CAT?`

**[:SOURce]:DECT:FLIS:LOAD 'name'**

The command loads a user-defined frame. This command triggers an event and hence has no \*RST value.

Example: `:SOUR:DECT:FLIS:LOAD 'test'`

**[:SOURce]:DECT:FLIS:STORE 'name'**

The command stores the current frame under a name. This command triggers an event and hence has no \*RST value and no query.

Example: `:SOUR:DECT:FLIS:STOR 'test'`

**[:SOURce]:DECT:FLIS:DELeTe 'name'**

The command deletes the indicated frame. This command triggers an event and hence has no \*RST value and no query.

Example: `:SOUR:DECT:FLIS:DEL 'test1'`

**[:SOURce]:DECT:DLIS:CATalog?**

The command returns an enumeration of all data lists.

These data lists are selected by means of `:DECT:SLOT:AFI:DLIS 'name'` and `...:BFI:DLIS 'name'` and used if `:DECT:SLOT:AFI DLIS` and `...:BFI DLIS` are set.

Example: `:SOUR:DECT:DLIS:CAT?`

**[:SOURce]:DECT:PREamble:TYPE NORMAl | PROLonged**

The command selects the 16-bit (NORMAl) or 32-bit (PROLonged) preamble.

Example: `:SOUR:DECT:PRE PROL PRO` \*RST value is NORM

**[:SOURce]:DECT:SLOT<i>**

The commands for setting the slot characteristics are under this node. Since a frame contains 24 slots, suffix 'i' is used to select the slot to be changed.  $i = [1] | 2 | \dots | 22 | 23$ . Slot 0 to 11 can be used for downlink and slot 12 to 23 for uplink. For double slot even numbers can be entered only since it occupies two full slots.

**[:SOURce]:DECT:SLOT<i>:TYPE FULL | DOUBle | ADATa**

The command selects the type of burst (slot) defined in the standard.

ADATa is All Data; the data source set with `SLOT<i>:BFIEld` is used.

Example: `:SOUR:DECT:SLOT2:TYPE ADAT` \*RST value is FULL

**[:SOURce]:DECT:SLOT<i>:LEVeL OFF | ATT | FULL**

The command determines the power stage of the slot.

OFF The slot is inactive

ATT The power is reduced by the amount defined by `:DECT:SLOT:ATT`

FULL Full power (predefined by level setting).

Example: `:SOUR:DECT:SLOT2:LEV ATT` \*RST value is FULL

**[[:SOURce]:DECT:SLOT<i>:PRESet**

The command sets all the following parameters of the slot to the values defined by the standard as a function of the type set above. This command triggers an event and hence has no \*RST value and no query.

Example: :SOUR:DECT:SLOT2:PRES

**[[:SOURce]:DECT:SLOT<i>:STSHift -9 to +9 (in bit)**

This command allows a timing shift of the indicated slot by the set number of bits to simulate a wrong timing (positive = delay; negative = advance).

Example: :SOUR:DECT:SLOT2:STSH -3 \*RST value is 0

**[[:SOURce]:DECT:SLOT<i>:RAMP:CW ON | OFF**

The command activates or deactivates the generation of unmodulated (CW) signal during the ramp time.

Example: :SOUR:DECT:SLOT2:PRAM:CW ON \*RST value is OFF

**[[:SOURce]:DECT:SLOT<i>:RAMP:DATA #B0 to #B111 to (12bit)**

The command sets the data used during the ramp time.

Example: :SOUR:DECT:SLOT2:PRAM:DATA #B111100001111  
\*RST value is 101010101010 / 010101010101 (downl./uplink)

**[[:SOURce]:DECT:SLOT<i>:PREamble:DATA #B0 to #B111 to (16bit)**

The command sets the data used for the 16-bit long preamble.

Example: :SOUR:DECT:SLOT2:PRE:DATA #B1111000011110000  
\*RST value is 1010101010101010 / 0101010101010101 (downlink/uplink)

**[[:SOURce]:DECT:SLOT<i>:PREamble:PROLonged:DATA #B0 to #B111 to (32bit)**

The command sets the data used for the 32-bit long preamble.

Example: :SOUR:DECT:SLOT2:PRE:PROL:DATA #B1111  
\*RST value 10101010101010101010101010101010 (downlink)  
\*RST value 01010101010101010101010101010101 (uplink)

**[[:SOURce]:DECT:SLOT<i>:SYNC #B0 to #B111 to (16bit)**

The command sets the data used for synchronization.

Example: :SOUR:DECT:SLOT2:SYNC #B0000111100001111  
RST value is 1110100110001010 / 0001011001110101 (downl./uplink)

**[[:SOURce]:DECT:SLOT<i>[:SOURce]:AFIeld PN9 | PN11 | PN15 | PN16 | PN20 | PN21 | PN23 | DLIS | SDATA**

The command defines the data source for the A field. It is either a PRBS generator (of different sequence length), a data list or the serial interface.

Example: :SOUR:DECT:SLOT3:AFI PN15 \*RST value is PN9

**[[:SOURce]:DECT:SLOT<i>[:SOURce]:AFIeld:DLIS 'name'**

The command selects a data list. This list is used only if lists have been set as data source using the command :DECT:SLOT:AFI DLIS. This command triggers an event and hence has no \*RST value.

Example: :DECT:SLOT:AFI:DLIS 'test'



**[[:SOURce]:DECT:SLOT<i>[:SOURce]:BField PN9 | PN11 | PN15 | PN16 | PN20 | PN21 | PN23 | DLIS | SDATa**

The command determines the data source for the B field. The data source set by means of this command is also used for SLOT:TYPE ADATa. It is either a PRBS generator (of different sequence length), a data list or the serial interface.

Example: :SOUR:DECT:SLOT3:BFI PN15 \*RST value is PN9

**[[:SOURce]:DECT:SLOT<i>[:SOURce]:BField:DLIS 'name'**

The command selects a data list. This list is used only if lists have been set as data source using the command :DECT:SLOT:BFI DLIS. This command triggers an event and hence has no \*RST value.

Example: :DECT:SLOT:BFI:DLIS 'test'

**[[:SOURce]:DECT:SLOT<i>[:SOURce]:ZField ON | OFF**

The command activates/deactivates the repetition of the content of the X field.

Example: :SOUR:DECT:SLOT2:ZFI ON \*RST value is ON

### 3.5.14.4 SOURce:DIST Subsystem

Subsystem DISTortion comprises all commands for setting the distortion simulator.  
The NDSim subsystem under CALibrate is available for the offset calibration.

Command	Parameter	Default Unit	Remark
<b>[[:SOURce]</b>			
<b>:DISTortion</b>			Not-SCPI
<b>[[:STATe]</b>	ON   OFF		
<b>:MODE</b>	POLYnomial   DATA		
<b>:DATA</b>			
<b>:CATalog?</b>	⇒ name {,name}...		Query only
<b>:SElect</b>	'name of characteristic'		
<b>:DElete</b>	'name of characteristic'		
<b>:ALL</b>			
<b>:AM</b>	-100 dB to 0 dB {, -100 dB to 0 dB }   block data	dB	
<b>:FREE?</b>			Query only
<b>:POINTs?</b>			Query only
<b>:AMBase</b>	-100 dB to 0 dB {, -100 dB to 0 dB }   block data	-	
<b>:POINTs?</b>			Query only
<b>:PM</b>	-180 degrees to +180 degrees {, -180 degrees to +180 degrees }   block data	dB	
<b>:FREE?</b>			Query only
<b>:POINTs?</b>			Query only
<b>:PMBase</b>	-100 dB to 0 dB {, -100 dB to 0 dB }   block data	-	
<b>:POINTs?</b>			Query only
<b>:LEVel</b>			
<b>:CORRection</b>	-20.0 to 6.00	dB	
<b>:POLYnomial</b>			Not-SCPI
<b>:AMAM</b>			
<b>:K&lt;i&gt;</b>	-10 dB to +10 dB	dB	
<b>:AMPM</b>			
<b>:K&lt;i&gt;</b>	-60 deg to +60 deg		
<b>:IFUNction</b>	ON   OFF		
<b>:LEVel</b>			
<b>:CORRection</b>	-20 dB to +6 dB	dB	
<b>:RECalculate</b>			

#### [[:SOURce]:DISTortion[:STATe] ON | OFF

This command switches the distortion function on or off.

Example: :SOUR:DIST ON

\*RST value is OFF

#### [[:SOURce]:DISTortion:MODE POLYnomial | DATA

Distortion data are calculated either by a list (:DIST:DATA... commands) or from the coefficients of a polynomial (:DIST:POLY... commands).

Example: :SOUR:DIST POLY

\*RST value is DATA

#### [[:SOURce]:DISTortion:DATA

The commands for the characteristics are under this node.

**[ :SOURce]:DISTortion:DATA:CATalog?**

This command outputs a list with the names of all characteristics stored in the unit separated by commas. The command is a query and hence has no \*RST value.

Example: :SOUR:DIST:DATA:CAT? Answer e.g.: TWTA, USER, ....

**[ :SOURce]:DISTortion:DATA:SElect '<name of characteristic>'**

This command selects the characteristic (data list) all other SOURCE:DIST:DATA: . . . commands refer to. If a new characteristic is to be generated, the name (max. 8 characters) can be entered here. A new characteristic is then created under this name. Up to 10 characteristics can be created. \*RST does not influence data lists.

Example: :SOUR:DIST:DATA:SEL "TWTA"

**[ :SOURce]:DISTortion:DATA:DElete '<name of characteristic>'**

This command deletes the indicated characteristic. \*RST does not influence data lists.

Example: :SOUR:DIST:DATA:DEL "TEST1"

**[ :SOURce]:DISTortion:DATA:DElete:ALL**

This command deletes all characteristics. \*RST does not influence data lists.

Example: :SOUR:DIST:DATA:DEL:ALL

**[ :SOURce]:DISTortion:DATA:AM -100 dB to 0 dB { , -100 dB to 0 dB } | block data**

This command fills the output values (y-axis) for the AM/AM conversion of the selected characteristic with data. The data can be transmitted as a list of any length separated by commas or as a binary block. If they are transmitted as block data, 8 (4) bytes are interpreted as floating-point value with double accuracy; settable with command FORMAT:DATA. \*RST does not influence data lists.

Example: :SOUR:DIST:DATA:AM -12.6,-7.8,-5.2,-4.4,-3.6,-3,-2.4,...

**[ :SOURce]:DISTortion:DATA:AM:FREE?**

This command outputs two values. One indicates the remaining storage capacity for new AM/AM characteristics and the other provides information about the space which is already occupied. All indications refer to the number of elements. The command is a query and hence has no \*RST value.

Example: :SOUR:DIST:DATA:AM:FREE? Answer e.g.: 30,0

**[ :SOURce]:DISTortion:DATA:AM:POINTs?**

The command provides the length of the output-value list (y-axis) of AM/AM conversion in elements. The command is a query and hence has no \*RST value.

Example: :SOUR:DIST:DATA:AM:POINTs? Answer e.g.: 0

**[ :SOURce]:DISTortion:DATA:AMBBase -100 dB to 0 dB { , -100 dB to 0 dB } | block data**

This command fills the input values (x-axis) for the AM/AM conversion of the selected characteristic with data. The data can be transmitted as a list of any length separated by commas or as a binary block. If they are transmitted as block data, 8 (4) bytes are interpreted as floating-point value with double accuracy; settable with FORM:DATA. \*RST does not influence data lists.

Example: :SOUR:DIST:DATA:AMB -23.5,-18.5,-15.5,-14.5,-13.5,...

**[[:SOURce]:DISTortion:DATA:AMBase:POINTs?**

This command provides the length of the input-value list (x-axis) of AM/AM conversion in elements. The command is a query and hence has no \*RST value.

Example: `:SOUR:DIST:DATA:AMB:POINTs?` Answer e.g.: 0

**[[:SOURce]:DISTortion:DATA:PM -180 degrees to +180 degrees {, -180 degrees to +180 degrees } | block data**

This command fills the output values (y-axis) for the AM/PM conversion of the selected characteristic with data. The data can be transmitted as a list of any length separated by commas or as a binary block. If they are transmitted as block data, 8 (4) bytes are interpreted as floating-point value with double accuracy; settable with command `FORMAT:DATA`. \*RST does not influence data lists.

Example: `:SOUR:DIST:DATA:PM 0,-1.2,-3.8,-9.5,-15.9,-23,-30.4,-43.4`

**[[:SOURce]:DISTortion:DATA:PM:FREE?**

This command outputs two values. One indicates the remaining storage capacity for new AM/PM characteristics and the other provides information about the space which is already occupied. All indications refer to the number of elements. The command is a query and hence has no \*RST value.

Example: `:SOUR:DIST:DATA:PM:FREE?` Answer e.g.: 30, 0

**[[:SOURce]:DISTortion:DATA:PM:POINTs?**

The command provides the length of the output-value list (y-axis) of AM/PM conversion in elements. The command is a query and hence has no \*RST value.

Example: `:SOUR:DIST:DATA:PM:POINTs?"` Answer e.g.: 0

**[[:SOURce]:DISTortion:DATA:PMBase -100 dB to 0 dB {, -100 dB to 0 dB } | block data**

This command fills the input values (x-axis) for the AM/PM conversion of the selected characteristic with data. The data can be transmitted as a list of any length separated by commas or as a binary block. If they are transmitted as block data, 8 bytes are interpreted as floating-point value; settable with command `FORMAT:DATA`. \*RST does not influence data lists.

Example: `:SOUR:DIST:DATA:PMB -23.5,-18.5,-15.5,-12.5,-9.5,-6.5,...`

**[[:SOURce]:DISTortion:DATA:PMBase:POINTs?**

The command provides the length of the input-value list (x-axis) of AM/PM conversion in elements. The command is a query and hence has no \*RST value.

Example: `:SOUR:DIST:DATA:PMB:POINTs?"` Answer e.g.: 0

**[[:SOURce]:DISTortion:DATA:LEVEL:CORRection -20 to +6.00 dB**

This command serves for setting the level correction for a particular characteristic.

Example: `:SOUR:DIST:DATA:LEV:CORR -3.12 dB` \*RST value is 0 dB

**[[:SOURce]:DISTortion:POLYnomial:AMAM:K<i> -10 dB to +10 dB**

The command sets the coefficients k2 to k5 for the AM-AM distortion.

Example: `:SOUR:DIST:POLY:AMAM:K3 3.4 dB` \*RST value is 0 dB

**[:SOURCE]:DISTortion:POLYnomial:AMPM:K<i> -60 deg to +60 deg**

The command sets the coefficients k2 to k5 for the AM-PM distortion.

Example:     : SOUR: DIST: POLY: AMPM: K4 12.8 deg                     \*RST value is 0 deg

**[:SOURCE]:DISTortion:POLYnomial:IFUNction ON | OFF**

The command switches on and off the inversion of the distortion characteristic to compensate an amplifier connected after the SMIQ.

Example:     : SOUR: DIST: POLY: IFUN ON                             \*RST value is OFF

**[:SOURCE]:DISTortion:POLYnomial:LEVel:CORRection -20 dB to +6 dB**

The command sets the level correction for the distortion characteristic from the polynomial coefficients.

Example:     : SOUR: DIST: DATA: LEV: CORR -3.12 DB                     \*RST value is 0 dB

**[:SOURCE]:DISTortion:RECalculate**

The distortion data transmitted to the unit via IEC/IEEE bus are loaded in the module and become active. This command triggers an action and therefore has no \*RST value.

Example:     : SOUR: DIST: REC

### 3.5.14.5 SOURce:DM Subsystem

In this subsystem, the types of digital standard modulation as well as vector modulation (I/Q modulation) are checked.

#### Vector Modulation

Command	Parameter	Default Unit	Remark
[:SOURce] :DM :IQ :STATe :CREStfactor :PRAMp :IMPairment [:STATe] :FILTer :STATe :FREQuency :TRANsition :LEAKage [:MAGNitude] :QUADrature :ANGLe :IQRatio [:MAGNitude] :IQSWap [:STATe]	ON   OFF 0 to 30 OFF   AEXternal ON   OFF ON   OFF 850 kHz   2.5 MHz   5 MHz, 7.5MHz NORMal   FAST 0 to 50.0 PCT -10.0 to 10.0 DEG -12.0 to 12.0 PCT ON   OFF	dB     Hz  PCT  DEG  PCT	Only with option SMIQB47

#### [:SOURce]:DM:IQ:STATe ON | OFF

This command switches vector modulation (I/Q modulation) on or off.

Example: :SOUR:DM:IQ:STAT ON

\*RST value: OFF

#### [:SOURce]:DM:IQ:CREStfactor 0 to 30 dB

This command sets the crest factor with vector modulation.

Example: :SOUR:DM:IQ:CRES 10

\*RST value: 0

#### [:SOURce]:DM:IQ:PRAMp OFF | AEXternal

This command switches the level control via the input socket (analog external).

Example: :SOUR:DM:IQ:PRAM AEXT

\*RST value: OFF

#### [:SOURce]:DM:IQ:IMPairment[:STATe] ON | OFF

This command activates (ON) or deactivates (OFF) the three tuning or correction values LEAKage, QUADrature and IQRatio for I/Q modulation.

Example: :SOUR:DM:IQ:IMP OFF

\*RST value: OFF

**[[:SOURce]:DM:IQ:FILTer**

The commands for the IQ filter settings are under this node.

**[[:SOURce]:DM:IQ:FILTer:STATe ON | OFF**

This command switches the IQ filter ON or OFF. It is only available with option SMIQB47 - LOW ACP Filter.

Example: `:SOUR:DM:IQ:FILT:STAT ON` \*RST value: OFF

**[[:SOURce]:DM:IQ:FILTer:FREQuency 850 kHz, 2.5 MHz, 5 MHz, 7.5 MHz**

This command selects an IQ filter with the limit frequencies 850 kHz, 2.5 MHz, or 5 MHz or **7.5 MHz**. It is only available with option SMIQB47 - LOW ACP Filter.

Example: `:SOUR:DM:IQ:FILT:FREQ 2.5MHZ` \*RST value is 2.5 MHz

**[[:SOURce]:DM:IQ:TRANSition NORMal | FAST**

The command switches over the setting time for the IQ filter. FAST should only be used if a fast switchover between CW and I/Q modulation is required.

Example: `:SOUR:DM:IQ:TRAN FAST` \*RST value is NORM

**[[:SOURce]:DM:LEAKage[:MAGNitude] 0 to 50.0 PCT**

This command adjusts the residual carrier amplitude for I/Q modulation.

Example: `:SOUR:DM:LEAK 3PCT` \*RST value: 0

**[[:SOURce]:DM:QUADrature:ANGLE -10.0 to 10.0 degree**

This command changes the quadrature offset for I/Q modulation.

Example: `:SOUR:DM:QUAD:ANGL -5DEG` \*RST value: 0

**[[:SOURce]:DM:IQRatio[:MAGNitude] -12.0 to 12.0 PCT**

This command adjusts the ratio of I and Q modulation (gain imbalance).

Example: `:SOUR:DM:IQR 4PCT` \*RST value: 0

**[[:SOURce]:DM:IQSWap[:STATe] ON | OFF**

This command interchanges the I and Q channels in position ON.

Example: `:SOUR:DM:IQSW OFF` \*RST value: OFF

## Digital Modulation

Command	Parameter	Default unit	Remark
[:SOURce]			
:DM			
:STATe	ON   OFF		
:SEQuence	AUTO   RETRigger   AAUTO   ARETrigger   SINGLE		
:SOURce	PRBS   PATtern   DLISt   SERial   PARallel   SDATa		
:PATtern	ZERO   ONE   ALTErnate		
:PRBS			
[:LENGth]	9   15   16   20   21   23		
:DLISt			
:DATA	0   1 {,0   1 } or block data		
:DATA?	[<start>[,<length>]]		query
:APPend	0 < 1 {,0   1 } or block data		no query
:CATAlog?			query only
:SElect	'name'		
:DELeTe	'name'		no query
:COPI	'name'		no query
:FREE?			query only
:POINts	<n>		
:CLISt			
:CONTRol			
[:STATe]	ON   OFF		
:DATA	<struc> {, <struc>}...		
:CATAlog?			query only
:SElect	'name'		
:DELeTe	'name'		no query
:COPI	'name'		no query
:FREE?			query only
:POINts?			query only
:MLISt			
:DATA	A,B,C,D,E,F, I1, Q1, I2, Q2...		
:CATAlog?			query only
:SElect	'name'		
:DELeTe	'name'		no query
:FREE?			query only
:POINts?			query only
:FLISt			
:DATA	A,B,C,D, I1, Q1, I2, Q2...		
:CATAlog?			query only
:SElect	'name'		
:DELeTe	'name'		no query
:FREE?			query only
:POINts?			query only
:STANdard	APCFm   APCQpsk   ASK   BLUetooth   CDPD   CT2   DECT   GSM   GSMEdge   IRIDium   FIS95   RIS95   NADC   PDC   PHS   TETRa   TFTS   PWT   QWCDma   ICOBpsk   ICOGmsk   ICOQpsk   WORLdspace   AT55		QWCDma only with option B47 WORLdspace with option B17



Command	Parameter	Default unit	Remark
[:SOURce]			
:DM			
:FORMat	GMSK   GFSK   BPSK   QPSK   QIS95   QICO   QWCDma   QINmarsat   OQPSk   OIS95   P4Qpsk   P4DQpsk   PSK8   PSKE8   QAM16 to 256   ASK   FSK2   FSK4   AFSK4   USER		QWCDma only with option SMIQB47
:MDElay?			Query only
:ASK			
:DEPTh	0 to 100	PCT	
:FSK			
:DEVIation	100 Hz to 2.5 MHz	Hz	
:SRATe	1 kHz to 7 MHz	Hz	
:FILTer			
:TYPE	SCOSine   COSine   GAUSs   LGAUss   BESS1   BESS2   IS95   EIS95   APCO   TETRa   WCDMa   RECTangle   SPHase   USER		
:PARAmeter	0.1 to 1.0		
:MODE	LACP   LEVM		
:CODing	OFF   GSM   NADC   PDC   PHS   TETRa   PWT   TFTS   DIFF   DGRay   DPHS   APCO25   INmarsat   VDL		
:CLOCK			
:SOURce	INTernal   EXTernal   COUpled		
:MODE	BIT   SYMBol		
:DELay	0 to 1.0		
:POLarity	NORMal   INVerted		
:LDISortion			
[:STATe]	ON   OFF		
:PRAMP			
[:STATe]	ON   OFF		
:SOURce	CLISt   AEXTernal   DEXTernal		
:TIME	0.25 to 32		
:DELay	-1.0 to 5.0		
:SHAPE	LINear   COSine		
:ATTenuation	0 to 70 dB		
:TRIGger		dB	
:SOURce	EXTernal   INTernal		
:INHibit	0 to 67.1E6		
:DELay	0 to 65535		
:SLOPe	POSitive   NEGative		
:THReshold			
[:ALL]	-2,5 to +2,5 V	V	
:INPut			
:IMPedance	G1K   G50   ECL		

**[[:SOURce]:DM:STATe ON | OFF**

The command switches the digital (user-defined, not stipulated by a standard) modulation on or off.

Example: `:SOUR:DM:STAT ON` \*RST value is OFF

**[[:SOURce]:DM:SEQUence AUTO | RETRigger | AAUTo | ARETrigger | SINGLE**

This command selects the trigger mode:

AUTO The sequence is repeated cyclically.

RETRigger The sequence is repeated cyclically. After the start, the sequence is restarted with each new trigger even before it is completed.

AAUTo ARMED AUTO. The sequence waits for a trigger signal. After the start, the trigger mode is AUTO and the sequence cannot be triggered anymore.

ARETrigger ARMED RETRIGGER. The sequence waits for a trigger signal. After the start, the sequence is restarted with each new trigger even before it is completed.

SINGLE After a trigger event, the sequence is only run once.

Example `:SOUR:DM:SEQ:AAUT` \*RST value is AUTO

**[[:SOURce]:DM:SOURce PRBS | PATTern | DLISt | SERial | PARallel | SDATa**

The command selects the data source.

PRBS internally generated pseudo random bit sequences.

PATT internally generated (fixed) data pattern.

DLISt internal data generator (only with DGEN).

SERial external serial interface.

PARallel external parallel interface.

SDATa asynchronous serial data input SER DATA.

Example: `:SOUR:DM:SOUR SER` \*RST value is PRBS

**[[:SOURce]:DM:PATTern ZERO | ONE | ALTErnate**

The command selects the data pattern. The data range is alternately assigned with 0 and 1 by means of ALTErnate.

Example: `:SOUR:DM:PATT ALT` \*RST value is ZERO

**[[:SOURce]:DM:PRBS[:LENGth] 9 | 15 | 16 | 20 | 21 | 23.**

The command determines the length of the pseudo random sequence according to the following equation:  $\text{Length} = (2^{\text{LENGth}}) - 1$

Example: `:SOUR:DM:PRBS 21` \*RST value is 15

**[[:SOURce]:DM:DLISt**

The commands for the data are under this node. Data lists are not affected by \*RST.

**[[:SOURce]:DM:DLISt:DATA 0 | 1 {0 | 1 }...**

This command transmits the bit data to the selected data list which is thus overwritten. The data can also be transmitted as block data in binary or PACKed format (see section: Parameter, Block Data). Each byte will then be interpreted as made up of 8 data bits. Here, the command `:SYST:COMM:GPIB:LTER EOI` should be used to set the delimiter mode to 'circuit message EOI only' so that an accidental LF within the data sequence is not first identified as a delimiter and thus momentarily interrupts the data transmission. The command `...LTER STAN` resets the delimiter mode. The data are not modified by \*RST.

Example:

```
:SOUR:DM:DLIS:DATA 0,1,1,0,0,0,0,1,0,1,0,1,1,0,0,0,0,0,1,0,1,1,0,1
:SOUR:DM:DLIS:DATA #13aX-
```

**[:SOURce]:DM:DLIS:DATA? [<start> [,<length>]]**

The command reads out the data list. If the query is enhanced by the two parameters start and length, the list will be read out in smaller parts. Start and length are given in bits.

Without parameters the whole length will always be output from address 1.

The data format is selected by means of the :FORMat ASCii | PACKed command. The order of the bytes is stipulated in the IEC/IEEE-bus standard (MSbyte first).

Example: :SOUR:DM:DLIS:DATA? 2048,1024

**[:SOURce]:DM:DLIS:DATA:APPend 0 | 1 {,0 | 1 }...**

The command allows the data lists, which can be very long (up to 20 Mbits = 2.5 Mbyte), to be transmitted in smaller parts. They are added to the end of already existing data.

First, the data list values have to be overwritten using the above DM:DLIS:DATA command. Further data can then be added using the DM:DLIS:DATA:APP commands. The data format is the same for the two commands.

Example: :SOUR:DM:DLIS:DATA:APP 0,1,1,0,0,0,0,0,1,0,1,1,0,1,0,0  
:SOUR:DM:DLIS:DATA:APP #12aX

**[:SOURce]:DM:DLIS:CATalog?**

The command returns a list of data list names separated by commas.

Example: :SOUR:DM:DLIS:CAT?

**[:SOURce]:DM:DLIS:SElect '<name>'**

The command selects the indicated data list. This list will only take effect as data source with mode :DM:SOURce DLIS selected. The list can only be filled with values if it has been selected beforehand. If the indicated list does not exist, it will be generated. <name> has to be put in brackets (<>) and may have up to 8 characters.

Example: :SOUR:DM:DLIS:SEL 'test'

**[:SOURce]:DM:DLIS:DElete '<name>'**

This command deletes the data list indicated by <name>. The name has to be put in brackets (<>) and may have up to 8 alphanumeric characters. This command triggers an event and hence has no \*RST value and no query.

Example: :SOUR:DM:DLIS:DEL 'test1'

**[:SOURce]:DM:DLIS:COpy '<name>'**

The command copies the selected list to the data list indicated by <name>. This command triggers an event and hence has no \*RST value and no query.

Example: :SOUR:DM:DLIS:COPY 'test1'

**[:SOURce]:DM:DLIS:FREE?**

This command returns the available free space for digital data (in bits) and the length of the selected list. The 2 values are separated by a comma.

Example: :SOUR:DM:DLIS:FREE?

**:SOURce]:DM:DLIS:POINts <n>**

The command indicates the number of elements (in bits) of the currently selected data list. Since only multiples of 8 bits can be transmitted when using block data, the exact number of used bits can be set here. Overflow bits in the list are ignored.

Example: :SOUR:DM:DLIS:POIN 234

**[[:SOURce]:DM:CLISt**

The commands for processing the control list are under this node. The control list contains the switching signals for the burst, the level, the modulation etc. The list index is with reference to the symbols in the data list and the list only contains the status changes. Control lists are not affected by \*RST.

**[[:SOURce]:DM:CLISt:CONTRol[:STATe] ON | OFF**

The command switches control on or off using the control list.

Example: `:SOUR:DM:CLIS:CONT ON`

\*RST value is OFF

**[[:SOURce]:DM:CLISt:DATA <struc>{,<struc>}...**

The command transmits the bit data to the selected control list which is then overwritten.

struc>=: `<symbol-index>, <bin>, <bin>, <bin>, <bin>, <bin>, <bin>`

<symbol-index> =: numeric value: 1 to 2<sup>26</sup> ( 67108864)

<bin> =: numeric value: 0 | 1

The data can also be transmitted as a binary block with <struc> being a 4 byte value in which the 26 LSBs represent the symbol index and the remaining 6 bits the binary values (see also section parameter, block data). Each byte is interpreted as made up of 8 data bits. Here, the command `:SYSTem:COMMunicate:GPIB:LTERminator EOI` should be used to set the delimiter mode to 'circuit message EOI only' so that an accidental LF within the data sequence is not first identified as a delimiter and thus momentarily interrupts the data transmission.

The command `...LTER STANDard` resets the delimiter mode.

For the query, switchover between the two formats given above is possible by means of the `:FORMat ASCii | PACKed` command. The order of bytes is stipulated in the IEC/IEEE-bus standard (MSByte first).

It should be noted that in the binary form the symbol index starts with 0. In the binary format this means that each symbol index is less by 1 than actually indicated on the screen and input/output via IEC/IEEE-bus in the ASCII format.

Example:

`:SOUR:DM:CLIS:DATA 12345678,0,1,1,0,0,0,23456789,1,0,0,1,0,0`

`:SOUR:DM:CLIS:DATA #18aX- 'y$?s`

The first two positions of the list are filled with the examples (with different values).

**[[:SOURce]:DM:CLISt:CATalog?**

The command returns a list of data list names separated by commas.

Example: `:SOUR:DM:CLIS:CAT?`

**[[:SOURce]:DM:CLISt:SElect '<name>'**

The command selects the indicated control list. This list only becomes effective as control list if the `:DM:PRAMP:SOURce CLISt` mode has been selected. The list can only be filled with values if it has been selected beforehand. If the indicated list does not exist, it will be generated. <name> has to be put in brackets (< >) and may have up to 8 characters.

Example: `:SOUR:DM:CLIS:SEL 'TEST2'`

**[[:SOURce]:DM:CLISt:DElete '<name>'**

The command deletes the control list indicated by <name>. This command triggers an event and hence has no \*RST value and no query

Example: `:SOUR:DM:CLIS:DEL 'TEST2'`

**[[:SOURce]:DM:CLIS:COPY '<name>'**

The command copies the selected list to the data list indicated by <name>. This command triggers an event and hence has no \*RST value and no query.

Example: :SOUR:DM:CLIS:COPY 'TEST2'

**[[:SOURce]:DM:CLIS:FREE?**

This command returns the available free space for the control data (lines consisting of 4 bytes) in elements.

Example: :SOUR:DM:CLIS:FREE?

**[[:SOURce]:DM:CLIS:POINts?**

The command returns the number of elements (lines consisting of 4 bytes) of the currently selected list.

Example: :SOUR:DM:CLIS:POIN?

**[[:SOURce]:DM:MLIS:DATA A,B,C,D,E,F,I1,Q1,I2,Q2...**

The command transmits the mapping data to the selected list which is therefore overwritten. The command can be used only if a list has been selected beforehand (compare with DM:MLIS:SELEct ).

- A: 1 for PSK modulation  
2 for QAM modulation  
3 for FSK modulation  
4 for PSK modulation with coding  
5 for QAM modulation with coding  
6 for FSK modulation with coding

B: 1 to 8, with  $B = \log_2 m$  (mapping states)

C: 0 if no delay is to be used in the Q-path  
1 if the Q-path is to be delayed by  $T_{symbol}/2$  (e.g. for offset QPSK)

D: 0, reserved

E: 0, reserved

F: 0, reserved

I,Q: Floating point values for I and Q; m values for I and Q must be defined for PSK and QAM modulation. For FSK all Q-values must be set to 0. The values have to be entered in ascending order starting with the least significant data symbol.

Example (for QPSK with  $m = 4$ , user mapping without coding):

:SOUR:DM:MLIS:DATA 1,2,0,0,0,0,0.7,0.7,-0.7,-0.7,0.7,-0.7

The example results in the following IQ mapping

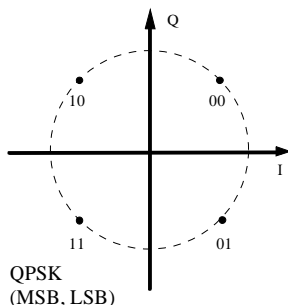

If data A is of value 4 to 6, a coding is activated. A variable number of values are added which are automatically set by application program UserMod<sup>1</sup>. The generation and transmission of a user mapping with or without coding can be performed by means of this program.

<sup>1</sup> Can be downloaded from Internet site <http://www.rohde-schwarz.com>.

**[ :SOURce]:DM:MLIS:CATalog?**

The command returns a list of mapping list names separated by commas.

Example: `:SOUR:DM:MLIS:CAT?`

**[ :SOURce]:DM:MLIS:SElect '<name>'**

The command selects the indicated user-defined mapping list. This list only becomes effective as modulation if the `:DM:FORMat USER` mode has been selected. The list can only be filled with values if it has been selected beforehand. If the indicated list does not exist, it will be generated. `<name>` has to be put in brackets (`< >`) and may have up to 8 characters.

Example: `:SOUR:DM:MLIS:SEL 'test'`

**[ :SOURce]:DM:MLIS:DElete '<name>'**

The command deletes the mapping list indicated by `<name>`. This command triggers an event and hence has no `*RST` value and no query

Example: `:SOUR:DM:MLIS:DEL 'TEST2'`

**[ :SOURce]:DM:MLIS:FREE?**

This command returns the available free space for the mapping data (lines consisting of 4 bytes) in elements.

Example: `:SOUR:DM:MLIS:FREE?`

**[ :SOURce]:DM:MLIS:POINts?**

The command returns the number of elements (numbers) of the currently selected list.

Example: `:SOUR:DM:MLIS:POIN?`

**[ :SOURce]:DM:FLIS:DATA A,B,C,D,I1,Q1,I2,Q2..**

The command transfers filter data to the selected list which is overwritten. The command can only be used if a list has been selected before (see `:DM:FLIS:SEL`).

A: Pulse length: 8, 16

B: Oversampling: 2 to 32, number of coefficients  $x = \text{pulse length} * \text{oversampling} \leq 256$ .

C: 6 dB bandwidth

D: 70 dB bandwidth

I,Q: Coefficients for *i* and *q* with PSK/QAM or for *f* with FSK. The coefficients are not used for *q* with FSK.

A user filter can be loaded and transferred by means of application program UserMod.

**[ :SOURce]:DM:FLIS:CATalog?**

The command returns a catalog of all available filter lists separated by comma.

Example: `:SOUR:DM:FLIS:CAT?`

**[ :SOURce]:DM:FLIS:SElect '<name>'**

The command selects the given user-defined filter list. This list is effective as a filter only if `:DM:FILTer:TYPE USER` mode is selected. Before the list can be filled up with values, it must be selected. If the indicated list does not exist, it will be generated. `<name>` should be put into brackets and have a maximum length of 7 characters.

Example: `:SOUR:DM:FLIS:SEL 'test'`

**[[:SOURce]:DM:FLIS:DELe]t <name>**

The command deletes the filter list specified by <name>. This command triggers an event and hence has neither \*RST value nor query.

Example: :SOUR:DM:FLIS:DEL 'TEST2'

**[[:SOURce]:DM:FLIS:FREE]?**

The command returns the free space available for filter data as a numeral.

Example: :SOUR:DM:FLIS:FREE?

**[[:SOURce]:DM:FLIS:POIN]ts?**

The command returns the number of values of the currently selected list.

Example: :SOUR:DM:FLIS:POIN?

**[[:SOURce]:DM:STAN]d APCFm | APCQpsk | ASK | BLUetooth | CDPD | CT2 | DECT | GSM | GSMEdge | IRIDIum | FIS95 | RIS95 | NADC | PDC | PHS | TETRa | TFTS | PWT | ICOBpsk | ICOGmsk | ICOQpsk | WORLdspace | QWCDma | AT55**

The command adjusts the modulation parameters MODULATION, SYMBOL RATE, FILTER and CODING to the selected standard. The default setting is USER. This setting is always activated automatically if one of the modulation parameters is changed and does not correspond to the selected standard. QWCDma is only available with option SMIQB47. WORLdspace only with option SMIQB17.

APCFm APCO4FM

APCQpsk APCOQPSK

Example: :SOUR:DM:STAN PHS \*RST value USER

**[[:SOURce]:DM:FORM]at BPSK | GFSK | GMSK | QPSK | QIS95 | QINMarsat | QICO | QWCDma | OQPSk | OIS95 | P4QPsk | P4DQpsk | PSK8 | PSKE8 | ASK | FSK2 | FSK4 | AFSK4 | QAM16 | QAM32 | QAM64 | QAM256 | USER**

The command selects the modulation. QWCDma is only available with option SMIQB47.

P4DQpsk  $\pi/4$ DQSPK

PSK2 is an alias for BPSK

PSK4 is alias for QPSK (according to SCPI).

QIS95 QPSK IS95

OIS95 OQPSK IS95

QWCDma WCDMA QPSK

AFSK4 4FSK APCO

USER The list selected with DM:MLIS:SEL... and defined via DM:MLIS:DATA... is used.

Example: :SOUR:DM:FORM GMSK \*RST value is P4DQpsk

**[[:SOURce]:DM:MDEL]ay?**

Value for time delay of digital modulation between data input/output and RF output of the SMIQ.

Example: :SOUR:DM:MDEL?

**[[:SOURce]:DM:ASK:DEPT]h 0 to 100 PCT**

The commands sets the input value for the ASK modulation depth.

Example: :SOUR:DM:ASK:DEPT 10 \*RST value is 100 PCT

**[:SOURce]:DM:FSK:DEVIation** 100 kHz to 2.5 MHz

The command sets the deviation for FSK (only for DM:FORMat FSK2, FSK4 and GFSK).

Example: `:SOUR:DM:FSK:DEV 9 kHz` \*RST value is 4.5 kHz

**[:SOURce]:DM:SRATe** 1kHz to 7 MHz

The command sets the symbol rate.

Example: `:SOUR:DM:SRAT 200 kHz` \*RST value is 24.3 kHz

**[:SOURce]:DM:FILTer**

The filter selection commands are under this node.

**[:SOURce]:DM:FILTer:TYPE** SCOSine | COSine | GAUSs | LGAuss | BESS1 | BESS2 | IS95 | EIS95 | APCO | TETRa | WCDMa | RECTangle | SPHase | USER

The command selects the type of filter.

BESS1 BESSEL B\*T 1.25

BESS2 BESSEL B\*T 2.50

EIS95 IS-95+EQUALIZER

APCO filter according to standard APCO modulation C4FM

USER The filter list selected with DM:FLIS:SEL... and defined via DM:FLIS:DATA... is used.

Example: `:SOUR:DM:FILT:TYPE GAUS` \*RST value is SCOS

**[:SOURce]:DM:FILTer:PARAmeter** 0.1 to 1.0

The command sets the filter parameter (Roff Off or BxT rate).

Example: `:SOUR:DM:FILT:PAR 1` \*RST value is 0.35

**[:SOURce]:DM:FILTer:MODE** LACP | LEVM

The command selects the filter mode.

Example: `:SOUR:DM:FILT:MODE LEVM` \*RST value is LACP

**[:SOURce]:DM:CODing** OFF | GSM | NADC | PDC | PHS | TETRa | TFTS | PWT | INMarsat | DIFF | DPHS | DGRay | APCO25 | VDL

The command selects the modulation coding (standard) .

DPHS PHASE DIFF

DGRay DIFF + DGRAY

Example: `:SOUR:DM:COD NADC` \*RST value is OFF

**[:SOURce]:DM:CLOCK**

The commands for setting the data clock are under this node.

**[:SOURce]:DM:CLOCK:SOURce** INTernal | EXTernal | COUPled

The command selects the source for the clock of the digital modulation.

INTernal The internal clock generator is used.

EXTernal The clock is fed externally.

COUPled The clock comes from the same source as the data. Selection is determined by `:DM:SOURce`.

Example: `:SOUR:DM:CLOC:SOUR INT` \*RST value is COUPled



**[:SOURce]:DM:CLOCK:MODE BIT | SYMBol**

The command selects the clock mode for :DM:CLOCK:SOURce EXTERNAL

BIT Only the input D\_CLOCK is used.

SYMBol Only the input S\_CLOCK is used.

The bit and symbol clock only differ for modulations with more than two states, i.e. modulations for which more than one bit is required to code each state.

Example: :SOUR:DM:CLOCK:MODE BIT \*RST value is SYMBol

**[:SOURce]:DM:CLOCK:DELay 0 to 1.0**

The command sets the delay of the symbol clock.

Example: :SOUR:DM:CLOCK:DEL 0.2 \*RST value is 0

**[:SOURce]:DM:CLOCK:POLarity NORMal | INVerted**

The command selects the active slope for the clock.

NORMal SLOPE POS.

INVerted SLOPE NEG

Example: :SOUR:DM:CLOCK:POL INV \*RST value is NORMal

**[:SOURce]:DM:LDISortion[:STATe] ON | OFF**

The command sets the reduced level for the low-distortion mode.

Example: :SOUR:DM:LDIS ON \*RST value is OFF

**[:SOURce]:DM:PRAMP**

The commands for the level control of the burst are under this node.

**[:SOURce]:DM:PRAMP[:STATe] ON | OFF**

The command switches the level control on or off.

Example: :SOUR:DM:PRAMP ON \*RST value is OFF

**[:SOURce]:DM:PRAMP:SOURce CLISt | AEXTernal | DEXTernal**

The command selects the level control.

CLISt The control list defined under :DM:CLISt controls the level (INT).

AEXT Analog signal at the burst control input controls the level.

DEXT Digital signals BURSt-GATE and LEV-ATT control the level.

Example: :SOUR:DM:PRAMP:SOUR DEXT \*RST value is CLISt

**[:SOURce]:DM:PRAMP:TIME 0.25 to 32**

The command sets the steep cutoff (as multiple of symbol length).

Example: :SOUR:DM:PRAMP:TIME 2.5 \*RST value is 3.0

**[:SOURce]:DM:PRAMP:DELay -1.0 to +5.0**

The command defines the shift of the envelope characteristic to the modulated signal. A positive value causes a delay of the envelope.

Example: :SOUR:DM:PRAMP:DEL 0.2 \*RST value is 0

**[[:SOURce]:DM:PRAMP:SHAPE** LINear | COSine

The command selects the linear or cosine-square shape of the ramp-up and ramp-down (power burst).

Example: `:SOUR:DM:PRAM:SHAP COS` \*RST value is COS

**[[:SOURce]:DM:PRAMP:ATTenuation** 0 to 70 dB

The command sets the level reduction value.

Example: `:SOUR:DM:PRAM:ATT 12 dB` \*RST value is 0 dB

**[[:SOURce]:DM:TRIGger:SOURce** EXTernal | INTernal

The command selects the trigger source.

EXT Triggering via external trigger input.

INT Triggering via IEC/IEEE bus or the Execute command of manual control.

Example: `:SOUR:DM:TRIG: EXT` \*RST value is INTernal

**[[:SOURce]:DM:TRIGger:INHibit** 0 to 67.1E6

The command sets the retrigger inhibit duration in number of symbols.

Example: `:SOUR:DM:TRIG:INH 12000` \*RST value is 0

**[[:SOURce]:DM:TRIGger:DELay** 0 to 65535

The command sets the trigger delay in number of symbols.

Example: `:SOUR:DM:TRIG:DEL 10` \*RST value is 0

**[[:SOURce]:DM:TRIGger:SLOPe** POSitive | NEGative

The command selects the active slope of the external trigger signal.

Example: `:SOUR:DM:TRIG:SLOP NEG` \*RST value is POSitive.

**[[:SOURce]:DM:THReshold[:ALL]** -2.5 to +2.5V

The command sets the voltage threshold of the digital data and clock inputs.

Example: `:SOUR:DM:THR 1 V` \*RST value is 1.0 V

**[[:SOURce]:DM:INPut:IMPedance** G1K | G50 | ECL

The command sets the impedance of all the data and clock inputs:

G1K 1 kOhm to ground

G50 50 Ohm to ground

ECL ECL-compatible input (only with option SMIQB10, not with option SMIQB20)

Example: `:SOUR:DM:INP:IMP G50` \*RST value is G1K

**3.5.14.6 SOURce:FM Subsystem**

This subsystem contains the commands to check the frequency modulation and to set the parameters of the modulation signal. The SMIQ can be equipped with two independent frequency modulators (option SM-B5). They are differentiated by a suffix after FM.

SOURce:FM1  
SOURce:FM2

Command	Parameter	Default Unit	Remark
<b>[:SOURce]</b> <b>:FM1 2</b>			Option SM-B5
<b>[:DEVIation]</b>	0 to 1MHz	Hz	
<b>:EXTernal1 2</b> <b>:COUPling</b>	AC   DC		
<b>:INTernal</b> <b>:FREQuency</b>	0.1 Hz to 1 MHz	Hz	
<b>:PREemphasis</b>	0   50us   75us		
<b>:SOURce</b>	INT   EXT1   EXT2		
<b>:STATe</b>	ON   OFF		

**[:SOURce]:FM1|2[:DEVIation] 0 to 1 MHz**

The command specifies the frequency variation caused by the FM. Although the LF generator is used as modulation sources, the frequency variation is independent of the voltage at the LF output. The maximally possible DEVIation depends on SOURce:FREQuency (cf. data sheet).

Example: :SOUR:FM1:DEV 5kHz \*RST value is 10 kHz

**[:SOURce]:FM1|2:EXTernal1|2**

The commands to set the external FM input are under this node. The settings under EXTernal for modulations AM, FM and PM are independent of each other. The settings are always related to the socket which is determined by the numeric suffix after EXTernal. The suffix after FM is ignored then. With the following commands, e.g., the settings are both related to EXT2 input:

:SOUR:FM1:EXT2:COUP AC  
:SOUR:FM2:EXT2:COUP AC

A command without suffix is interpreted like a command with suffix 1.

**[:SOURce]:FM1|2:EXTernal1|2:COUPling AC | DC**

The command selects the type of coupling for the external FM input.

AC The d.c. voltage content is separated from the modulation signal.

DC The modulation signal is not altered.

\*RST value is AC

Example: :SOUR:FM:EXT:COUP AC

**[:SOURce]:FM1|2:INTernal**

The settings for the internal FM generators are effected under this node. For FM1, this is always the internal LF generator. Here the same hardware is set for FM1, PM1, AM:INT as well as SOURce2. For FM2, only the external sources can be used (not the internal LF generator).

This means that, e.g., the following commands are coupled with each other and have the same effect:

SOUR:AM:INT:FREQ  
SOUR:FM:INT:FREQ  
SOUR:PM:INT:FREQ  
SOUR2:FREQ:CW

**[[:SOURce]:FM1|2:INTernal:FREQuency 0.1 Hz to 1 MHz**

The command sets the modulation frequency.

Example: `:SOUR:FM:INT:FREQ 10kHz`

\*RST value is 1 kHz

**[[:SOURce]:FM1|2:PREemphasis 0 | 50us | 75us**

The command selects the preemphasis.

0 No preemphasis

50 us 50  $\mu$ s, European standard 50  $\mu$ s

75 us 75  $\mu$ s, American standard 75  $\mu$ s

Example: `:SOUR:FM:PRE 50us`

\*RST value is 0

**[[:SOURce]:FM1|2:SOURce INTernal | EXTernal1 | EXTernal2**

The command selects the modulation source. A command without suffix is interpreted like a command with suffix 1. The LF generator is INT for FM1. The external and the internal modulation source can be indicated at the same time (see example)

Example: `:SOUR:FM:SOUR INT1, EXT2`

\*RST value for FM1: INT  
for FM2:EXT2

**[[:SOURce]:FM1|2:STATe ON | OFF**

The command switches the frequency modulation on or off.

Example: `SOUR:FM:STAT OFF`

\*RST value is OFF.

### 3.5.14.7 SOURce:FREQUENCY Subsystem

This subsystem contains the commands for the frequency settings of the RF source including the sweeps.

Command	Parameter	Default Unit	Remark
[:SOURce]			
:FREQUency			
:CENTer	300 kHz to RF <sub>max</sub>	Hz	RF <sub>max</sub> depends on model
[:CW]:FIXed]	300 kHz to RF <sub>max</sub>	Hz	RF <sub>max</sub> depends on model
:RCL	INCLude   EXCLude		
:MANual	300 kHz to RF <sub>max</sub>	Hz	RF <sub>max</sub> depends on model
:MODE	CW   FIXed   SWEep   LIST		
:OFFSet	-50 to +50 GHz	Hz	
:SPAN	0 to RF <sub>max</sub>	Hz	RF <sub>max</sub> depends on model
:STARt	300 kHz to RF <sub>max</sub>	Hz	RF <sub>max</sub> depends on model
:STOP	300 kHz to RF <sub>max</sub>	Hz	RF <sub>max</sub> depends on model
:STEP			
[:INCRement]	0 to 1 GHz	Hz	

**[:SOURce]:FREQUency:CENTer** 300 kHz to RF<sub>max</sub> (RF<sub>max</sub> depending on model)

The command sets the sweep range by means of the center frequency. This command is coupled to commands :SOURce:FREQUency:STARt and :SOURce:FREQUency:STOP.

In this command, value OFFSet is considered as with input value FREQUENCY in the header field. Thus the specified range indicated is only valid for OFFSet = 0. The specified range with other OFFSet values can be calculated according to the following formula (cf. Chapter 2, Section "Frequency Offset" as well):

$$300 \text{ kHz} + \text{OFFSet} \text{ to } 2.2 \text{ GHz} + \text{OFFSet} \quad \text{*RST value is } (\text{STARt} + \text{STOP})/2$$

Example: :SOUR:FREQ:CENT 100kHz

**[:SOURce]:FREQUency[:CW]:FIXed]** 300 kHz to RF<sub>max</sub> (RF<sub>max</sub> depending on model)

The command sets the frequency for CW operation. This value is coupled to the current sweep frequency. In addition to a numeric value, UP and DOWN can be indicated. The frequency is increased or reduced by the value set under :SOURce:FREQUency:STEP. (As to specified range, cf. FREQUency:CENTer).

Example: :SOUR:FREQ:CW 100kHz \*RST value is 100 MHz

**[:SOURce]:FREQUency[:CW]:FIXed]:RCL** INCLude | EXCLude

The command determines the effect of the recall function on the frequency. \*RST value has no effect to this setting.

INCLude The saved frequency is loaded when instrument settings are loaded with the [RECALL] key or with a memory sequence.

EXCLude The RF frequency is not loaded when instrument settings are loaded, the current settings are maintained.

Example: :SOUR:FREQ:RCL INCL

**[:SOURce]:FREQUency:MANual** 300 kHz to RF<sub>max</sub> (RF<sub>max</sub> depending on model)

The command sets the frequency if SOUR:SWE:MODE MAN and SOUR:FREQ:MODE SWE are set. Only frequency values between the settings with :SOUR:FREQ:STAR and :SOUR:FREQ:STOP are permitted. (As to specified range, cf. FREQ:CENT) \*RST value is 100 MHz

Example: :SOUR:FREQ:MAN 500MHz

**[[:SOURce]:FREQuency:MODE CW | FIXed | SWEep | LIST**

The command specifies the operating mode and hence also specifies which commands check the FREQuency subsystem. The following allocations are valid

CW | FIXed CW and FIXed are synonyms. The output frequency is specified by means of  
:SOUR:FREQ: CW | FIX.

SWEep The instrument operates in the SWEep operating mode. The frequency is specified by means of commands SOUR:FREQ:STAR; STOP; CENT; SPAN; MAN.

LIST The instrument processes a list of frequency and level settings. The settings are effected in the SOURce:LIST subsystem. Setting SOUR :FREQ:MODE LIST automatically sets command SOUR:POW:MODE to LIST as well.

Example: :SOUR:FREQ:MODE SWE \*RST value is CW

**[[:SOURce]:FREQuency:OFFSet -50 to + 50 GHz**

The command sets the frequency offset of an instrument which might be series-connected, e.g. a mixer. (cf. Chapter 2, Section "Frequency Offset"). If a frequency offset is entered, the frequency entered using SOURce:FREQuency: to does no longer correspond to the RF output frequency. The following connection is true:

SOURce:FREQuency:to = RF output frequency + SOURce:FREQuency:OFFSet.

Entering an offset does not alter the RF output frequency but the query value of SOURce:FREQuency:..

Example: :SOUR:FREQ:OFFS 100MHz \*RST value is 0

**[[:SOURce]:FREQuency:SPAN 0 to RF<sub>max</sub> (RF<sub>max</sub> depending on model)**

This command indicates the frequency range for the sweep. This parameter is coupled to the start and stop frequency. Negative values for SPAN are permitted, then START > STOP is true. There is the following connection:

START = CENTer – SPAN/2

STOP = CENTer + SPAN/2

\*RST value is (STOP - START)

Example: :SOUR:FREQ:SPAN 1GHz

**[[:SOURce]:FREQuency:START 300 kHz to RF<sub>max</sub> (RF<sub>max</sub> depending on model)**

This command indicates the starting value of the frequency for the sweep operation. Parameters START, STOP, SPAN and CENTer are coupled to each other. START may be larger than STOP. (As to specified range, cf. FREQuency:CENTer). \*RST value is 100MHz

Example: :SOUR:FREQ:STAR 1MHz

**[[:SOURce]:FREQuency:STOP 300 kHz to RF<sub>max</sub> (RF<sub>max</sub> depending on model)**

This command indicates the final value of the frequency for the sweep operation (see START as well). (As to specified range, cf. FREQuency:CENTer). \*RST value is 500MHz

Example: :SOUR:FREQ:STOP 100MHz

**[[:SOURce]:FREQuency:STEP**

The command to enter the step width for the frequency setting if frequency values UP or DOWN are used is under this node. This command is coupled to the KNOB STEP command in manual control. Only linear step widths can be set.

**[[:SOURce]:FREQuency:STEP[:INCRement] 0 to 1 GHz**

The command sets the step width for the frequency setting.

Example: :SOUR:FREQ:STEP:INCR 1MHz

\*RST value is 1MHz

3.5.14.8 SOURce:FSIM-Subsystem

The FSIM system comprises the commands for the fading simulator (options SMIQB14, SMIQB15, SMIQB49).

Command	Parameter	Default-Unit	Remark
[:SOURce]			
:FSIMulator			Option SMIQB14
[:STANdard]			
[:STATe]	ON   OFF		
:CONFigure	S6Path   S12Path   D6Path		S12P/D6P only w. SMIQB15
:SEQuence	RUN   STOP		
:RESet			
:IGNore			
:RFCHanges	ON   OFF		
:STANdard	CDMA8   CDMA30   CDMA100   NADC8   NADC50   NADC100   GTU3   G6TU3   GTU50   G6TU50   GHT100   G6HT100   GRA250   GET50   GET100   PTU1   P6TU1   PTU50   P6TU50   PHT100   P6HT100   PRA130   PET50   PET100   TTU   THT   TET		
:SPEed			
:UNIT	MPS   KMPH   MPH		
:ILOSs			
:MODE	NORMal   LACP		
:COUple			
:SPEed	ON   OFF		
:CORRelation			
:COEFFicient	ON   OFF		
:LOGNormal			
:LCONstant	ON   OFF		
:CSTD	ON   OFF		
:CFACtor			
:EXTern?			query only
:DEFault			
:PATH<i>	<i> = [1]   2 to 6 (12)		7 to 12 only with SMIQB15
:STATe	ON   OFF		
:PROFile	PDOPpler   RAYLeigh   RICE   CPHase		
:DCOMponent			
:STATe	ON   OFF		
:PRATio	-30.0 to +30.0 dB	dB	
:FRATio	-1.0 to +1.0		
:CPHase	0 to 360	DEG	
:SPEed	0.005 to 27 777 MPS		depending on FSIM:SPE:UNIT: MPS   KMPH   MPH
:FDOPpler	0.1 to 1600.0 Hz	Hz	
:LOSS	0 to 50.0 dB	dB	
:DELay	0 to 1638.0E-6	s	
:CORRelation			
:PATH	0   7 to 12		
:COEFFicient			
:PHASe	0 to 359	DEG	
:LOGNormal			
:STATe	ON   OFF		
:LCONstant	1 to 99 999		
:CSTD	0 to 12.0	dB	

With option SMIQB49 only

Command	Parameter	Default unit	Remarks
<b>[[:SOURce]</b>			
<b>:FSIMulator</b>			Option SMIQB14
<b>:FDElay</b>			FineDelay
<b>[[:STATe]</b>	ON   OFF		
<b>:STANdard</b>	G3C1   G3C2   G3C3 G3C4   G3UEC1   G3UEC2   G3UEC3   G3UEC4   G3UEC5   G3UEC6		
<b>:SPEed</b>			
<b>:UNIT</b>	MPS   KMPH   MPH		
<b>:DEFault</b>	(without)		
<b>:PATH&lt;i&gt;</b>	<i> = [1]   2 to 4		3 and 4 only with SMIQB15
<b>:STATe</b>	ON   OFF		
<b>:PROFile</b>	PDOPpler   RAYLeigh		
<b>:FRATio</b>	-1.0 to +1.0		
<b>:SPEed</b>	0.005 to 27 777 MPS		depending on FSIM:SPE:UNIT: MPS   KMPH   MPH
<b>:FDOPpler</b>	0.1 to 1600.0 Hz	Hz	
<b>:LOSS</b>	0 to 50.0 dB	dB	
<b>:DElay</b>	25 ns to 1637 us	s	
<b>:MDElay</b>			MovingDelay
<b>[[:STATe]</b>	ON   OFF		
<b>:DEFault</b>	(without)		
<b>:REFerence</b>			
<b>:LOSS</b>	0 to 50.0 dB	dB	
<b>:DElay</b>	0 to 1638.0E-6	s	
<b>:MOVing</b>			
<b>:LOSS</b>	0 to 50.0 dB	dB	
<b>:DElay</b>		s	
<b>:MEAN</b>	0.25 us to 1637.8 us	s	
<b>:VARIation</b>	300 ns to 100 us	s	
<b>:VPERiod</b>	10 s to 500 s	s	
<b>:BIRTHdeath</b>			
<b>[[:STATe]</b>	ON   OFF		
<b>:SPEed</b>			
<b>:UNIT</b>	MPS   KMPH   MPH		
<b>:LOSs</b>			
<b>:MODE</b>	NORMal   LACP		
<b>:DEFault</b>	(without)		
<b>:PATH&lt;i&gt;</b>	<i> = [1]   2		
<b>:PROFile</b>	PDOPpler		
<b>:FRATio</b>	-1.0 to +1.0		
<b>:SPEed</b>	0.005 to 27 777 MPS		depending on FSIM:SPE:UNIT: MPS   KMPH   MPH
<b>:FDOPpler</b>	0.1 to 1600.0 Hz	Hz	
<b>:LOSS</b>	0 to 50.0 dB	dB	
<b>:DElay</b>	5 us to 1000 us	s	
<b>:HOPPing</b>			
<b>:DWELI</b>	100 ms to 5.0s	s	only PATH1



**[[:SOURce]:FSIMulator[]]**

The standard settings for the fading simulator that are available without Option SMIQB49 are under this node.

**[[:SOURce]:FSIMulator:ALL[:STATe] ON | OFF]**

This command switches the fading simulator on or off. The switch-on states of subgroups Standard, FDElay, MDElay and BIRTHdeath remain unchanged. If, however, one of the subgroups is switched on (...:STATE ON), ON is automatically set.

Example: :SOUR:FSIM OFF \*RST value is OFF

**[[:SOURce]:FSIMulator[:STATe] ON | OFF]**

Switches the standard fading on or off. \*RST value: OFF

Example: :SOUR:FSIM ON

**[[:SOURce]:FSIMulator:CONFigure S6Path | S12Path | D6Path]**

Defines the number of active paths and channels. S12Path and D6Path are only possible with option SMIQB15.

S6Path Single channel, 6 active paths

S12Path Single channel, 12 active paths

D6Path Dual channel, 6 active paths

Example: :SOUR:FSIM:CONF S6P \*RST value: S6P/S12P (without/with option SMIQB15)

**[[:SOURce]:FSIMulator:SEQuence RUN | STOP]**

This command starts (RUN) or stops (STOP) the Pseudo Noise Generator for generating the fading process.

Example: :SOUR:FSIM:SEQ RUN \*RST value: STOP

**[[:SOURce]:FSIMulator:SEQuence:RESet]**

This command resets the pseudo random sequence for the fading to its original value. FSIMulator:SEQuence is set to STOP (and has to be restarted with RUN). Since this command triggers an event it has no \*RST value.

Example: :SOUR:FSIM:SEQ:RES

**[[:SOURce]:FSIMulator:IGNore:RFCHanges]**

This command sets the status for recalculating the fading signals. When ON is selected, RF changes <5% do no longer cause a recalculation.

Example: :SOUR:FSIM:IGN:RFCH ON \*RST value is OFF

[[:SOURce]:FSIMulator[:STANdard CDMA8 | CDMA30 | .....]

Selects the fading standard. All subsequent FSIM commands are set to a predefined value. The parameters with a '6' as second character select the 6-path mode (this mode must be set if option SMIQB15, Second Fading Generator is not available).

CDMA8, CDMA30, CDMA100

NADC8, NADC50, NADC100

GTU3, G6TU2, GTU50, G6TU50

GHT100, G6HT100

GRA250

GET50, GET100

PTU1, P6TU1, PTU50, P6TU50

PHT100, P6HT100

PRA130

PET50, PET100

TTU

THT

TET

GSM Typical Urban

GSM Hilly Terrain

GSM Rural Area

GSM Equal Test

DCS1800/PCS1900 Typical Urban

DCS1800/PCS1900 Hilly Terrain

DCS1800/PCS1900 Rural Area

DCS1800/PCS1900 Equal Test

Tetra Typical Urban

Tetra Hilly Terrain,

Tetra Equal Test

Example: :SOUR:FSIM:STAN NADC50

\*RST value: CDMA8



**[[:SOURce]:FSIMulator[:PATH<i>]**

The following commands can be separately set for each path. The path is selected with the suffix <i>; <i> being assigned a value from 1 to 6 (one fading simulator) or 1 to 12 (two fading simulators).

**[[:SOURce]:FSIMulator:PATH<i>:STATE ON | OFF**

This command switches the selected path on or off.

Example: :SOUR:FSIM:PATH3:STAT ON \*RST value is OFF

**[[:SOURce]:FSIMulator:PATH<i>:PROFile PDOPpler | RAYLeigh | RICE | CPHase**

This command assigns a fading profile (scattering image) to the selected path.

PDOPpler pure Doppler profile.

RAYLeigh standard Rayleigh profile

RICE standard Rice profile

CPHase constant phase

Example: :SOUR:FSIM:PATH3:PROF RICE \*RST value is RAYL

**[[:SOURce]:FSIMulator:PATH<i>:DCOMponent:STATe ON | OFF**

This command switches the discrete components on or off.

\*RST value is OFF

Example: :SOUR:FSIM:PATH3:CCOM:STAT ON

**[[:SOURce]:FSIMulator:PATH<i>:PRATio -30 to +30 dB**

This command sets the power ratio (for RICE profile only). The resolution is 0.1 dB.

Example: :SOUR:FSIM:PATH3:PRAT -20 \*RST value is 0

**[[:SOURce]:FSIMulator:PATH<i>:FRATio -1.0 to +1.0**

The command sets the frequency ratio (for RICE profile only). The resolution is 0.1.

Example: :SOUR:FSIM:PATH3:FRAT 0.5 \*RST value is 1

**[[:SOURce]:FSIMulator:PATH<i>:CPHase 0 to 360 DEG**

The command sets the phase for CPHAS fading.

Example: :SOUR:FSIM:PATH6:CPH 20.0 \*RST value is 0

**[[:SOURce]:FSIMulator:PATH<i>:SPEed 0.005 to 27 777 ( in MPS (m/s))**

This command sets the vehicle speed. The unit is defined separately with the command FSIM:SPEed:UNIT.

Example: :SOUR:FSIM:PATH3:SPE 10.0 \*RST value is 20 MPS

**[[:SOURce]:FSIMulator:PATH<i>:FDOPpler 0.1 to 1600 Hz**

This command specifies the Doppler frequency (coupled to the vehicle speed). The resolution is 0.1 Hz.

Example: :SOUR:FSIM:PATH3:FDOP 100 \*RST value is 6.7

**[[:SOURce]:FSIMulator:PATH<i>:LOSS 0 to 50.0 dB**

This command sets the path loss. The resolution is 0.1 dB.

\*RST value is 0

Example: :SOUR:FSIM:PATH3:LOSS 20

**[:SOURce]:FSIMulator:PATH<i>:DELay** 0 to 1638.0E-6

This command sets the signal delay in the path. The resolution is 50 ns. \*RST value is 0  
 Example: :SOUR:FSIM:PATH3:DEL 123E-6

**[:SOURce]:FSIMulator:PATH<i>:CORRelation**

This node provides the commands for setting the correlation to another path (only with option SMIQB15).

**[:SOURce]:FSIMulator:PATH<i>:CORRelation:PATH** 0 | 7 to 12

This command defines the correlating path 7 to 12 for path <n>. If no correlation exists, 0 is selected.  
 Example: :SOUR:FSIM:PATH3:CORR:PATH 12 \*RST value is 0

**[:SOURce]:FSIMulator:PATH<i>:CORRelation:COEFFicient** 0 to 1.0

This command sets the correlation coefficient. The resolution is 0.05. \*RST value is 1  
 Example: :SOUR:FSIM:PATH3:CORR:COEF 0.3

**[:SOURce]:FSIMulator:PATH<i>:CORRelation:PHASe** 0 to 359 degree

This command sets the correlation phase. The resolution is 1 degree. \*RST value is 0  
 Example: :SOUR:FSIM:PATH3:CORR:PHAS 180

**[:SOURce]:FSIMulator:PATH<i>:LOGNormal**

This node provides the commands for setting the lognormal fading.

**[:SOURce]:FSIMulator:PATH<i>:LOGNormal:STATe** ON | OFF

This command switches lognormal fading on or off. \*RST value is OFF  
 Example: :SOUR:FSIM:PATH3:LOGN:STAT OFF

**[:SOURce]:FSIMulator:PATH<i>:LOGNormal:LCONstant** 1 to 99 999

This command enters the local constant in meters. The unit is not a component of this command. The resolution is 0.1 m. \*RST value is 200  
 Example: :SOUR:FSIM:PATH3:LOGN:LCON 50

**[:SOURce]:FSIMulator:PATH<i>:LOGNormal:CSTD** 0 to 12.0 dB

This command sets the standard deviation of lognormal fading. The resolution is 1 dB. \*RST value is 0  
 Example: :SOUR:FSIM:PATH3:LOGN:CSTD 2.0

**[:SOURce]:FSIMulator:FDELay[:STATe]** ON | OFF

This command switches the fine delay fading simulation on or off. \*RST value is OFF  
 Example: :SOUR:FSIM:FDEL ON

**[:SOURce]:FSIMulator:FDELay:STANdard** G3C1 | G3C2 | G3C3 | G3C4 | G3UEC1 | G3UEC2 | G3UEC3 | G3UEC4 | G3UEC5 | G3UEC6

This command selects the fading standard for the fine delay simulation.

- G3C1 3GPP\_BS\_4.1.0.\_Case1
- G3C2 3GPP\_BS\_4.1.0.\_Case2 (with SMIQ15 only)
- G3C3 3GPP\_BS\_4.1.0.\_Case3 (with SMIQ15 only)

G3C4          3GPP\_BS\_4.1.0.\_Case4 (with SMIQ15 only)

G3UEC1      3GPP\_UE\_4.1.0.\_Case1

G3UEC2      3GPP\_UE\_4.1.0.\_Case2 (with SMIQ15 only)

G3UEC3      3GPP\_UE\_4.1.0.\_Case3 (with SMIQ15 only)

G3UEC4      3GPP\_UE\_4.1.0.\_Case4

G3UEC5      3GPP\_UE\_4.1.0.\_Case5

G3UEC6      3GPP\_UE\_4.1.0.\_Case6( only with SMIQ15)

Example:      :SOUR:FSIM:FDEL:STAN G3C1          \*RST value is G3C1 (G3C2 with SMIQB15)

                :SOUR:FSIM:FDEL:STAN G3UEC1

#### [[:SOURCE]:FSIMulator:FDElay:SPEed:UNIT MPS | KMPH | MPH

This command sets the unit for the speed of fine delay simulation.

MPS          m/s, meter per second

KMPH        Km/h, kilometer per hour

MPH          Miles per hour

Example:      :SOUR:FSIM:FDEL:SPE:UNIT MPH          \*RST value is MPS

#### [[:SOURCE]:FSIMulator:FDElay:DEFault

This command sets the default setting of the path parameters for the fine delay simulation (as for \*RST). This command triggers an event and hence has no \*RST value and no query.

Example:      :SOUR:FSIM:FDEL:DEF

#### [[:SOURCE]:FSIMulator:FDElay:PATH<i>

The following commands can be set individually for each path. The path is selected with suffix <i> which has valid values of 1 to 4 (3 and 4 only with option SMIQB15).

#### [[:SOURCE]:FSIMulator:FDElay:PATH<i>:STATE ON | OFF

This command activates or deactivates the selected path for the fine delay simulation.

Example:      :SOUR:FSIM:FDEL:PATH3:STAT ON          \*RST value is path 1, 2 ON; 3, 4 OFF

#### [[:SOURCE]:FSIMulator:FDElay:PATH<i>:PROFile PDOPpler | RAYLeigh

This command assigns the selected path a fading profile for the fine delay simulation.

PDOPpler    Pure Doppler Profile

RAYLeigh   Standard Rayleigh

Example:      :SOUR:FSIM:FDEL:PATH3:PROF PDOP          \*RST value is RAYL

#### [[:SOURCE]:FSIMulator:FDElay:PATH<i>:FRATio -1.0 to +1.0

This command sets the frequency ratio (Freq. Ratio) for the fine delay simulation. The resolution is 0.1.

Example:      :SOUR:FSIM:FDEL:PATH3:FRAT 0.5          \*RST value is 1

**[[:SOURce]:FSIMulator:FDElay:PATH<i>:SPEed** 0.005 to 27 777 (in MPS (m/s))

This command sets the speed of the moving receiver for the fine delay simulation. The unit is specified with the `FSIM:SPEed:UNIT` command and is not part of this command.

Example: `:SOUR:FSIM:FDEL:PATH3:SPE 10.0` \*RST value is 20 MPS

**[[:SOURce]:FSIMulator:FDElay:PATH<i>:FDOPpler** 0.1 to 1600 Hz

This command defines the Doppler frequency (coupled with the vehicle speed) for the fine delay simulation. The resolution is 0.1 dB.

Example: `:SOUR:FSIM:FDEL:PATH3:FDOP 100` \*RST value is 6.7

**[[:SOURce]:FSIMulator:FDElay:PATH<i>:LOSS** 0 to 50.0 dB

This command enters the signal loss in the path for the fine delay simulation. The resolution is 0.1 dB.

Example: `:SOUR:FSIM:FDEL:PATH3:LOSS 20` \*RST value is 0 (PATH1)  
 3 (PATH2)  
 6 (PATH3)  
 9 (PATH4)

**[[:SOURce]:FSIMulator:FDElay:PATH<i>:DELay** 25ns to 1637us

This command enters the signal delay in the path for the fine delay simulation.

Example: `:SOUR:FSIM:FDEL:PATH3:DEL 123E-6` \*RST value is 25 ns

**[[:SOURce]:FSIMulator:MDElay[:STATe] ON | OFF**

This command switches the moving delay simulation on or off.

Example: `:SOUR:FSIM:MDEL ON` \*RST value is OFF

**[[:SOURce]:FSIMulator:MDElay:DEFault**

This command sets the default setting of the path parameters for the moving delay simulation (as for \*RST). This command triggers an event and hence has no \*RST value and no query.

Example: `:SOUR:FSIM:MDEL:DEF`

**[[:SOURce]:FSIMulator:MDElay:REFerence:LOSS** 0 to 50.0 dB

This command enters the signal loss in the path for the moving delay simulation. The resolution is 0.1 dB.

Example: `:SOUR:FSIM:MDEL:REF:LOSS 20` \*RST value is 0

**[[:SOURce]:FSIMulator:MDElay:REFerence:DELay** 0 to 1638.0E-6S

This command enters the signal delay in the path for the moving delay simulation.

Example: `:SOUR:FSIM:MDEL:REF:DEL 123E-6` \*RST value is 0

**[[:SOURce]:FSIMulator:MDELay:MOVing:LOSS 0 to 50.0 dB**

This command enters the signal loss in the path for the moving delay simulation. The resolution is 0.1 dB.

Example: `:SOUR:FSIM:MDEL:MOV:LOSS 20` \*RST value is 0

**[[:SOURce]:FSIMulator:MDELay:MOVing:DELay:MEAN 0.25us to 1637.8us**

This command enters the mean value of the moving path delay for the moving delay simulation.

Example: `:SOUR:FSIM:MDEL:MOV:DEL:MEAN 123E-6` \*RST value is 5 us

**[[:SOURce]:FSIMulator:MDELay:MOVing:DELay:VARiation 300ns to 100us**

This command enters the range for delay variation for the moving path (moving delay simulation).

Example: `:SOUR:FSIM:MDEL:MOV:DEL:VAR 123E-6` \*RST value is 5 us

**[[:SOURce]:FSIMulator:MDELay:MOVing:VPERiod 10 to 500s**

This command enters the speed of delay variation in the path for the moving delay simulation.

Example: `:SOUR:FSIM:MDEL:MOV:VPER 12` \*RST value is 157 s

**[[:SOURce]:FSIMulator:BIRThdeath[:STATe] ON | OFF**

This command switches the Birth-Death simulation on or off.

Example: `:SOUR:FSIM:BIRT ON` \*RST value is OFF

**[[:SOURce]:FSIMulator:BIRThdeath:SPEed:UNIT MPS | KMPH | MPH**

This command sets the unit for the speed of Birth-Death simulation.

MPS m/s, meter per second

KMPH Km/h, kilometer per hour

MPH Miles per hour

Example: `:SOUR:FSIM:BIRT:SPE:UNIT MPH` \*RST value is MPS

**[[:SOURce]:FSIMulator:BIRThdeath:ILOSs:MODE NORMAl | LACP**

This command sets the insertion loss of the fading simulator for the Birth-Death simulation.

NORMAl The insertion loss is fixed to 18 dB, which is optimal for BER measurements.

LACP The insertion loss is between 12 and 14 dB to obtain a better S/N ratio, for instance during adjacent-channel measurements.

Example: `:SOUR:FSIM:BIRT:ILOS:MODE LACP` \*RST value is NORM

**[[:SOURce]:FSIMulator:BIRThdeath:DEFault**

This command sets the default setting of the path parameters for the Birth-Death simulation (as after \*RST). This command triggers an event and hence has no \*RST value and no query.

Example: `:SOUR:FSIM:BIRT:DEF`

**[[:SOURce]:FSIMulator:BIRThdeath:PATH<i>**

The following commands can be set individually for each path. The path is selected with suffix <i> which has valid values of 1 to 2.



**[[:SOURce]:FSIMulator:BIRThdeath:PATH<i>:PROFile PDOPpler**

This command assigns the selected path a fading profile for the Birth-Death simulation.

PDOPpler Pure Doppler profile

Example: :SOUR:FSIM:BIRT:PATH2:PROF PDOP \*RST value is PDOP

**[[:SOURce]:FSIMulator:BIRThdeath:PATH<i>:FRATio -1.0 to +1.0**

This command sets the frequency ratio for the Birth-Death simulation. The resolution is 0.1.

Example: :SOUR:FSIM:BIRT:PATH2:FRAT 0.5 \*RST value is 1

**[[:SOURce]:FSIMulator:BIRThdeath:PATH<i>:SPEed 0.005 to 27 777 (in MPS (m/s))**

This command sets the speed of the moving receiver for the Birth-Death simulation. The unit is specified with the `FSIM:SPEed:UNIT` command and is not part of this command. The value can only be set for path 1 and is taken for PATH2.

Example: :SOUR:FSIM:BIRT:PATH:SPE 10.0 \*RST value is 27.778 MPS

**[[:SOURce]:FSIMulator:BIRThdeath:PATH<i>:FDOPpler 0.1 to 1600 Hz**

This command defines the Doppler frequency (coupled with the vehicle speed). The resolution is 0.1 dB. The value can only be set for path 1 and is taken for PATH2.

Example: :SOUR:FSIM:BIRT:PATH:FDOP 100 \*RST value is 9.3

**[[:SOURce]:FSIMulator:BIRThdeath:PATH<i>:LOSS 0 to 50.0 dB**

This command enters the signal loss in the path for the Birth-Death simulation. The resolution is 0.1 dB.

Example: :SOUR:FSIM:BIRT:PATH2:LOSS 20 \*RST value is 0

**[[:SOURce]:FSIMulator:BIRThdeath:PATH<i>:DELay 5us to 1000us**

This command enters the signal delay in the path for the Birth-Death simulation. The value can only be set for path 1 and is taken for PATH2.

Example: :SOUR:FSIM:BIRT:PATH:DEL 123E-6 \*RST value is 5us

**[[:SOURce]:FSIMulator:BIRThdeath:PATH<i>:HOPPing:DWELI 100ms to 5s**

This command sets the dwell time up to the next Birth-Death action.

Example: :SOUR:FSIM:BIRT:PATH:HOPP:DWEL 12.3MS \*RST value is 191 ms

### 3.5.14.9 SOURce:GPS Subsystem

This subsystem contains the commands for simulating a GPS satellite.

Command	Parameter	Default unit	Remark
<b>[[:SOURce]</b>			
<b>:GPS</b>			
<b>:STATe</b>	ON   OFF		
<b>:PRESet</b>			
<b>:STANdard</b>	(without)		
<b>:RF</b>	(without)		
<b>:SEQUence</b>	AUTO   RETRigger   AAUTo   ARETrigger   SINGle		
<b>:TRIGger</b>			
<b>:SOURce</b>	INTernal   EXTernal		
<b>:DELay</b>	0 to 20 359	(chips)	
<b>:INHibit</b>	0 to 67 108 863	(chips)	
<b>:OUTPut[1]2</b>	CODE   NBIT   NWORd   SFRame   FRAME		
<b>:POLarity</b>	POSitive   NEGative		
<b>:DELay</b>	0 to 6 137 999	(chips)	
<b>:CURRent</b>			
<b>:FREQuency?</b>		Hz	Query only
<b>:SRATe?</b>		(symb/s)	Query only
<b>:DSHift</b>	-10kHz to 10kHz	Hz	
<b>:SRATe</b>	500 000.0 to 1 500 000.0	(symb/s)	
<b>:CODE</b>	1 to 37		
<b>:DATA</b>	PATTErn   DLISt		
<b>:PATTErn</b>	#B0 to #B1111111111111111, 1 to 16		1 to 16 bit
<b>:DLISt</b>	'name'		
<b>:DLISt</b>			
<b>:CATalog?</b>	=> name, name...		Query only

#### [[:SOURce]:GPS:STATe ON | OFF

The command switches the signal generation of a simulated GPS satellite on or off.

Example: :SOUR:GPS:STAT ON.

\*RST value is OFF

#### [[:SOURce]:GPS:PRESet:STANdard

The command sets all the modulation parameters to the values of the GPS standard as with \*RST (i.e., it does not set the parameters selected with the :GPS:PRESet:RF command described below, the GPS triggers or the GPS-sequence parameter. This command triggers an event and hence has no \*RST value and no query.

Example: :SOUR:GPS:PRESet:STAN

**[[:SOURce]:GPS:PRESet:RF**

The command sets the RF-parameter frequency to 1.57542 GHz and level to -125 dBm (the values of the GPS standard). This command triggers an event and hence has no \*RST value and no query.

Example: :SOUR:GPS:PRES:RF

**[[:SOURce]:GPS:SEQuence AUTO | RETRigger | AAUTo | ARETrigger**

The command selects the trigger mode for the sequence.

AAUTo is ARMED AUTO

ARETrigger is ARMED RETRIG

Example: :SOUR:GPS:SEQ AAUT \*RST value is AUTO

**[[:SOURce]:GPS:TRIGger:SOURce EXTernal | INTernal**

The command selects the trigger source. With INT selected, triggering in remote control is via the Trigger command, or via the Execute command in manual control.

Example: :SOUR:GPS:TRIG:SOUR EXT \*RST value is INT

**[[:SOURce]:GPS:TRIGger:DELay 0 to 20359**

The command specifies the delay for an external trigger signal in number of chips prior to initiating a start.

Example: :SOUR:GPS:TRIG:DEL 200 \*RST value is 0

**[[:SOURce]:GPS:TRIGger:INHibit 0 to 67.1E6**

The command sets the retrigger suppression time (in number of chips).

Example: :SOUR:GPS:TRIG:INH 1000 \*RST value is 0

**[[:SOURce]:GPS:TRIGger:OUTPut[1]|2 CODE | NBIT | NWORD | SFRame | FRAME**

The command selects the signal for trigger output 1 or 2.

CODE At the beginning of the C/A code sequence

SFRame Sub Frame

Example: :SOUR:GPS:TRIG:OUTP2 NBIT \*RST value OUTP1: NWORD, OUTP2: SFR

**[[:SOURce]:GPS:TRIGger:OUTPut[1]|2:POLarity POSitive | NEGative**

The command sets the polarity of the signal at trigger output 1 or 2.

Example: :SOUR:GPS:TRIG:OUTP2:POL NEG \*RST value is POS

**[[:SOURce]:GPS:TRIGger:OUTPut[1]|2:DELay 0 to 6137999**

The command determines the delay of the signal at trigger output 1 or 2 in number of chips.

Example: :SOUR:GPS:TRIG:OUTP2:DEL 16 \*RST value is 0

**[[:SOURce]:GPS:CURREnt:FREQuency?**

The command queries the physically output carrier frequency.

Example: :SOUR:GPS:CURR:FREQ?

**[[:SOURce]:GPS:CURRent:SRATe?**

The command queries the resulting symbol rate.

Example: `:SOUR:GPS:CURR:SRAT?`

**[[:SOURce]:GPS:DSHift -10 kHz to 10 kHz**

The command sets the Doppler shift.

Example: `:SOUR:GPS:DSH -2.1 kHz` \*RST value is 0

**[[:SOURce]:GPS:SRATe 500000 to 1500000**

The command sets the symbol rate (in symb/s) (without Doppler shift).

Example: `:SOUR:GPS:SRAT 1020000` \*RST value is 1023000

**[[:SOURce]:GPS:CODE 1 to 37**

The command sets the C/A code for spreading the navigation data.

Example: `:SOUR:GPS:CODE 19` \*RST value is 1

**[[:SOURce]:GPS:DATA PATTErn | DLIS**

The command determines the data source for the navigation data.

Example: `:SOUR:GPS:DATA DLIS` \*RST value is PATT

**[[:SOURce]:GPS:DATA:PATTErn #B0 to #B111 to 1, 1 to 24**

This command sets the bit pattern used for `:SOUR:GPS:DATA PATT`. The first parameter sets the bit pattern (optionally in hex, oct or bin notation); the second indicates the number of bits to be used.

Example: `:SOUR:GPS:DATA:PATT #H3F,8` \*RST value is #B0,1

**[[:SOURce]:GPS:DATA:DLIS 'name'**

The command selects a data list. This list is only used if `DLIS` is set as the data source with the `:GPS:DATA` command. This command triggers an event and hence has no \*RST value.

Example: `:SOUR:GPS:DATA:DLIS 'test'`

**[[:SOURce]:GPS:DLIS:CATalog?**

The command returns a list of all the user-defined data lists for GPS.

Example: `:SOUR:GPS:DLIS:CAT?`

3.5.14.10 SOURce:GSM Subsystem (Digital Standard GSM/EDGE)

**Note:** #B0 to #B1 are characters which are entered in binary form manually. SCPI (and IEEE 488.2) also accept the entry of non-numeric characters in octal and hex such as #H|h <0 to 9, A|a to F|f>, #Q|q <0 to 7> and #B|b <0|1>. The characters are always output in binary format after a query.

Command	Parameter	Default unit	Remark
[:SOURce]			
:GSM			
:STATe	ON   OFF		
:STANdard	(without)		No query
:FORMat	GMSK   GFSK		
:FSK			
:DEVIation	1kHz to 300 kHz	Hz	
:SRATe	1kHz to 300 kHz	Hz	
:FILTer			
:TYPE	GAUSSs		
:PARAmeter	0.2 to 0.7		
:SEQUence	AUTO   RETRigger   AAUTo   ARETrigger		
:TRIGger			
:SOURce	EXTernal   INTernal		
:INHibit	0 to 67.1E6		
:DELay	0 to 65535		
:OUTPut[1 2]	SLOT   FRAMe		Output 1 only
:DELay	0 to 1249		
:POLarity	POSitive   NEGative		
:PERiod	1 to 67.1E6		Output 2 only
:CLOCK			
:SOURce	INTernal   EXTernal		
:DELay	0 to 1.0		
:PRAMP			
:PRESet	(without)		No query
:TIME	0.25 to 16		
:SHAPe	LINear   COSine		
:DELay	-1.0 to +1.0		
:ROFFset	-9 to +9		
:FOFFset	-9 to +9		
:SLOT		DB	
:ATTenuation	0 to 70 dB		
:FLISt			
:PREDefined			
:CATalog?	=> name {,name}...		query only
:LOAD	'name'		
:CATalog?	=> name {,name}...		Query only
:LOAD	'name'		
:STORe	'name'		No query
:DELete	'name'		No query

Command	Parameter	Default unit	Remark
[:SOURce] :GSM :DLISt :CATalog? :SLOT<i> :TYPE :LEVel :PRESet :HOPPing :TRIGger [:SOURce] :DATA :DLISt :SF :TSC :SElect :USER	=> name {,name}...  NORMal   DUMMy   ADATa   EDGE OFF   ATT   FULL (without) ON   OFF  PN9   PN11  PN15   PN 16   PN20   PN21   PN23   DLISt   SDATa 'name' 0   1  T0 to T7   USER #B0 to #B1111 to (26 bits)		Query only i=0,[1],2 to 7 (Slot Selector)

#### [:SOURce]:GSM:STATe ON | OFF

The command switches the modulation on according to GSM standard. All other standards that might be switched on or digital modulation are automatically switched OFF.

Example:   : SOUR:GSM:STAT ON

\*RST value is OFF

#### [:SOURce]:GSM:STANdard

The command sets all modulation parameters to the values of the GSM standard. I.e., all values that have been selected by the :GSM:SLOT... commands described in the following are not valid. This command triggers an event and hence has no \*RST value and no query.

Example:   : SOUR:GSM:STAN

#### [:SOURce]:GSM:FORMat GMSK | GFSK

This command selects the modulation type.

Example:   : SOUR:GSM:FORM GFSK

\*RST value is GMSK

#### [:SOURce]:GSM:FSK:DEVIation 1kHz to 300 kHz

This command sets the deviation for GSM:FORMat GFSK. The range of values depends on the symbol rate (GSM:SRATe).

Example:   : SOUR:GSM:FSK:DEV 37.6kHz

\*RST value is 67.708 kHz

#### [:SOURce]:GSM:SRATe 1kHz to 300 kHz

The command sets the symbol rate.

Example:   : SOUR:GSM:SRAT 270.9 kHz

\*RST value is 270.833 kHz

#### [:SOURce]:GSM:FILTer:TYPE GAUSs

The command selects the filter type.

Example:   : SOUR:GSM:FILT:TYPE USER

\*RST value is GAUS

**[:SOURce]:GSM:FILTer:PARAmeter 0.2 to 0.7**

The command sets the filter parameter.

Example: `:SOUR:GSM:FILT:PAR 0.4`

\*RST value is 0.3

**[:SOURce]:GSM:SEQuence AUTO | RETRigger | AAUTo | ARETrigger**

The command selects the trigger mode for the sequence.

AAUTo is ARMED AUTO

ARETrigger is ARMED RETRIG

Example: `:SOUR:GSM:SEQ AAUT`

\*RST value is AUTO

**[:SOURce]:GSM:TRIGger:SOURce EXTernal | INTernal**

The command selects the trigger source. With INT selected, triggering is via IEC/IEEE bus or the Execute command in manual control.

Example: `:SOUR:GSM:TRIG:SOUR EXT`

\*RST value is INT

**[:SOURce]:GSM:TRIGger:INHibit 0 to 67.1E6**

The command sets the retrigger inhibit duration (in number of symbols).

Example: `:SOUR:GSM:TRIG:INH 1000`

\*RST value is 0

**[:SOURce]:GSM:TRIGger:DELay 0 to 65535**

The command sets the trigger delay (in number of symbols).

Example: `:SOUR:GSM:TRIG:DEL 200`

\*RST value is 0

**[:SOURce]:GSM:TRIGger:OUTPut SLOT | FRAME**

The command selects the signal for trigger output 1 (output 2 is always FRAME).

Example: `:SOUR:GSM:TRIG:OUTP SLOT`

\*RST value is FRAM

**[:SOURce]:GSM:TRIGger:OUTPut[1]|2:POLarity POSitive | NEGative**

The command sets the polarity of the signal at trigger output 1 or 2.

Example: `:SOUR:GSM:TRIG:OUTP2:POL NEG`

\*RST value is POS

**[:SOURce]:GSM:TRIGgerOUTPut[1]|2:DELay 0 to 1249**

The command determines the delay of the signal at trigger output 2 in comparison with the start of the frames/slots in number of symbols.

Example: `:SOUR:GSM:TRIG:OUTP2:DEL 16`

\*RST value is 0

**[:SOURce]:GSM:TRIGger:OUTPut[2]:PERiod 1 to 67.1E6**

The command sets the repeat rate (in number of frames) of the signal at trigger output 2.

Example: `:SOUR:GSM:TRIG:OUTP2:PER 8`

\*RST value is 1

**[:SOURce]:GSM:CLOCK**

The commands for setting the data clock are under this node.

**[:SOURce]:GSM:CLOCK:SOURce INTernal | EXTernal**

The command selects the source for the DM data clock.

**INTernal** The internal clock generator is used and output via the clock outputs of the serial and parallel interface.

**EXTernal** The clock is externally fed in via the serial interface and output via the parallel interface.

Example: :SOUR:GSM:CLOC:SOUR INT \*RST value is INT

#### **[[:SOURce]:GSM:CLOCK:DELay 0 to 1.0**

The command sets the delay of the symbol clock (as a fraction of the length of a symbol).

Example: :SOUR:GSM:CLOC:DEL 0.75 \*RST value is 0

#### **[[:SOURce]:GSM:PRAMP**

The commands for the level control of the burst are under this node.

#### **[[:SOURce]:GSM:PRAMP:PRESet**

This command sets the standard-stipulated values for the following commands of level control. It is an event and hence has no query and no \*RST value.

Example: :SOUR:GSM:PRAM:PRES

#### **[[:SOURce]:GSM:PRAMP:TIME 0.25 to 16.0**

The command sets the cutoff steepness (in symbol clocks).

Example: :SOUR:GSM:PRAM:TIME 2.5 \*RST value is 5

#### **[[:SOURce]:GSM:PRAMP:DELay -1.0 to + 1.0**

The command defines the shift of the envelope characteristic to the modulated signal. A positive value causes a delay of the envelope.

Example: :SOUR:GSM:PRAM:DEL 0.2 \*RST value is 0

#### **[[:SOURce]:GSM:PRAMP:SHAPe LINear | COSine**

The command selects the linear or cosine shape of the ramp-up and ramp-down (power burst).

Example: :SOUR:GSM:PRAM:SHAP COS \*RST value is COS

#### **[[:SOURce]:GSM:PRAMP:ROFFset -9 to +9**

The command determines the timing of the ('R'ising) edge of a power burst to the beginning of the block.

Example: :SOUR:GSM:PRAM:ROFF -3 \*RST value is 0

#### **[[:SOURce]:GSM:PRAMP:FOFFset -9 to +9**

The command determines the timing of the ('F'alling) edge of a power burst to the data block.

Example: :SOUR:GSM:PRAM:FOFF 4 \*RST value is -1

#### **[[:SOURce]:GSM:SLOT:ATTenuation 0 to -70 dB**

The command determines the amount by which the power of the slots marked by :GSM:SLOT:LEVel ATT is reduced in comparison with the normal output power (attribute to :LEVel FULL).

Example: :SOUR:GSM:SLOT:ATT 20 dB \*RST value is 0



**[:SOURce]:GSM:FLISt**

The commands for storing and reading complete frames including their bursts (slots) are under this node. Predefined and user-generated frames have to be distinguished.

**[:SOURce]:GSM:FLISt:PREDeFined:CATalog?**

The command returns a list of all predefined frames.

Example: `:SOUR:GSM:FLIS:PRED:CAT?`

**[:SOURce]:GSM:FLISt:PREDeFined:LOAD 'name'**

The command selects one of the predefined (fixed) frames (c.f. Chapter 2). This command triggers an event and hence has no \*RST value.

Example: `:SOUR:GSM:FLIS:PRED:LOAD 'NB0'`

**[:SOURce]:GSM:FLISt:CATalog?**

The command returns a list of all user-defined frames.

Example: `:SOUR:GSM:FLIS:CAT?`

**[:SOURce]:GSM:FLISt:LOAD 'name'**

The command loads a user-defined frame. This command triggers an event and hence has no \*RST value.

Example: `:SOUR:GSM:FLIS:LOAD 'test'`

**[:SOURce]:GSM:FLISt:STORe 'name'**

The command stores the current frame under a name. This command triggers an event and hence has no \*RST value.

Example: `:SOUR:GSM:FLIS:STOR 'test'`

**[:SOURce]:GSM:FLISt:DELeTe 'name'**

The command deletes the indicated frame. This command triggers an event and hence has no \*RST value and no query.

Example: `:SOUR:GSM:FLIS:DEL 'test1'`

**[:SOURce]:GSM:DLISt:CATalog?**

The command returns an enumeration of all data lists.

These data lists are selected by means of `:GSM:SLOT:DATA 'name'` and used if `:GSM:SLOT:DATA DLISt` is set.

Example: `:SOUR:GSM:DLIS:CAT?`

**[:SOURce]:GSM:SLOT<i>**

The commands for setting the slot characteristics are under this node. Since a frame contains 8 slots, suffix 'i' is used to select the slot to be changed. `i = 0 | [1] | 2 | 3 | 3 | 5 | 6 | 7`

**[:SOURce]:GSM:SLOT<i>:TYPE NORM | DUMMy | ADATa | EDGE**

The command selects the type of burst (slot) defined in the standard.

ADATa is All Data

Example: `:SOUR:GSM:SLOT2:TYPE DUMM`

\*RST value is NORM

**[[:SOURce]:GSM:SLOT<i>:LEVeL OFF | ATT | FULL**

The command determines the power stage of the slot.

OFF The slot is inactive

ATT The power is reduced by the amount defined by :GSM:SLOT:ATT

FULL Full power (predefined by level setting)

Example: :SOUR:GSM:SLOT2:LEV ATT

Slot 0: \*RST value is FULL

Slot 1 to 7: \*RST value is OFF

**[[:SOURce]:GSM:SLOT<i>:PRESet**

The command sets all the parameters of the slot to the values defined by the standard as a function of the type set above. This command triggers an event and hence has no \*RST value and no query.

Example: :SOUR:GSM:SLOT2:PRES

**[[:SOURce]:GSM:SLOT<i>:HOPPing:TRIGger ON | OFF**

This command provides a trigger signal at the PARData connector (ON). This signal can be used to perform frequency hopping in the LIST MODE.

Example: :SOUR:GSM:SLOT2:HOPP:TRIG ON

\*RST value is OFF

**[[:SOURce]:GSM:SLOT<i>[:SOURce]:DATA PN9 | PN15 | PN16 | PN20 | PN21 | PN23 | DLIS | SDATA**

The command determines the data source for the data words (for :SLOT:TYPE NORM and ADATA).

Example: :SOUR:GSM:SLOT2:DATA PN15

\*RST value is PN9

**[[:SOURce]:GSM:SLOT<i>[:SOURce]:DATA:DLIS 'name'**

The command selects a data list. This list will not be used unless it is set as a data source by means of the :GSM:SLOT:DATA DLIS command. This command triggers an event and hence has no \*RST value.

Example: :GSM:SLOT:DATA:DLIS 'test'

**[[:SOURce]:GSM:SLOT<i>:SF 0 | 1**

This command sets the stealing flag (GSM:SLOT:TYPE NORM only)

Example: :SOUR:GSM:SLOT2:SFR:STAT ON

\*RST value is OFF

**[[:SOURce]:GSM:SLOT<i>:TSC:SElect T0 to T7 | USER**

This commands selects the training sequence code. T0 to T7 are the values stipulated by GSM 5.02. With USER selected as parameter, the given value described with the following . . . :TSC:USER command will be used.

Example: :SOUR:GSM:SLOT2:TSC:SEL T3

\*RST value is T0

**[[:SOURce]:GSM:SLOT<i>:TSC:USER #B0 to #B1111... (26/78 bits)**

The TSC value is determined by the user by means of this command. TSC will be used if the parameter (!) USER is set by means of the above-mentioned :GSM:SLOT:TSC:SEL command. The value contains 78 bits only with :GSM:SLOT:TYPE EDGE.

Example: :SOUR:GSM:SLOT3:TSC:USER #B01101100110011100011111100

\*RST value is 111111111

3.5.14.11 SOURce:IS95 Subsystem (Digital Standard IS-95 CDMA)

Command	Parameter	Default unit	Remark
[:SOURce]			
:IS95			
:STATe	ON   OFF		
:MODE	FLINK18   FLINK64   RLINK		
:PRESet			
:CRATe	1 kHz to 7 MHz	Hz	
:FILTer			
:FTYPE	SCOSine   COSine   IS95   EIS95   USER		
:RTYPE	SCOSine   COSine   IS95   EIS95   USER		
:FSElect	'name'		
:RSElect	'name'		
:PARAmeter	0.1 to 0.7		
:MODE	LACP   LEVM		
:LDISortion			
[:STATe]	ON   OFF		
:SEQuence	AUTO   RETRigger   AAUTo   ARETrigger		
:TRIGger			
:SOURce	EXTernal   INTernal		
:INHibit	0 to 67108863		
:DELay	0 to 65535		
:OUTPut[1] 2	TFRame   SSRollover   SFRame   ESECond		
:DELay	-32768 to 32768		
:POLarity	POSitive   NEGative		
:CLOCK			
:MODE	CHIP   CHIP4   CHIP8   CHIP16		
:SOURce	INTernal   EXTernal		
:DELay	0 to 1.00		
:POWER?			query only
:ADJust	-		
:MAPPING			
:PREDefined			
:CATalog?	=> name {,name}		query only
:LOAD	'name'		
:CATalog?	=> name {,name}		query only
:LOAD	'name'		No query
:STORE	'name'		No query
:DELeTe	'name'		No query
:CHANnel<0..63>			
:WALShcode	0 to 63		
:POWER	-30 dB to 0 dB	dB	
:DATA	ZERO   ONE   ALTErnate   PRBS		
:STATe	ON   OFF		
:RATE	FULL   HALF		
:RANDomizer			
[:STATe]	ON   OFF		
:DATA	ZERO   ONE   ALTErnate   PRBS   DATA		

Command	Parameter	Default unit	Remark
[:SOURce] :IS95			
:DLISt	'name'		
:CATalog?	⇒ name {,name}...		query only
:RLCoded			
:CTYPe	TRAF14400   TRAF7200   TRAF3600   TRAF1800   ACC4800   TRAF9600   TRAF4800   TRAF2400   TRAF1200		
:DATA	PN9   PN11  PN15   PN16   PN20   PN21   PN23   DLISt		
:DLISt	'name'		
:FQINDicator	ON   OFF		
:CENCoder	ON   OFF		
:BINTerleaver	ON   OFF		
:EBIT	0   1		

**[:SOURce]:IS95:STATe** ON | OFF

The command switches the modulation on according to the IS95 standard which is a CDMA method. All other standards or digital modulation that might be switched on are automatically switched off (OFF).

Example:   : SOUR: IS95: STAT ON

\*RST value is OFF

**[:SOURce]:IS95:MODE** FLINK18 | FLINK64 | RLINK | RLCoded

The command selects the operating mode.

FLINK18   Forward Link with 18 code channels

FLINK64   Forward Link with 64 code channels

RLINK     Reverse Link (from mobile station to base station)

RLCoded   Reverse Link Coded

Example:   : SOUR: IS95: MODE RLIN

**[:SOURce]:IS95:PRESet**

The command sets all the following settings into a defined default state (as with to \*RST). It can thus be guaranteed that a signal is generated at all and that it is in line with standard. This command triggers an event and hence has no \*RST value and no query.

Example:   : SOUR: IS95: PRES

**[:SOURce]:IS95:CRATe** 1 kHz to 7 MHz

The command sets the chip rate.

Example:   : SOUR: IS95: CRAT 1.21 MHz

\*RST value is 1.2288 MHz

**[:SOURce]:IS95:FILTer**

The commands for selecting a filter are under this node.

**[:SOURce]:IS95:FILTer:FTYPE** SCOSine | COSine | IS95 | EIS95 | USER

The command selects the type of filter for the Forward Link Mode (IS95:FLINK18 or IS95:FLINK64). A filter list should be selected with :DECT:FILT:SEL 'name' for the filter type USER.

SCOSine Square root cosine (root Nyquist) filter  
 COSine Cosine (Nyquist)-filter  
 IS95 Filter according to Interim Standard 95  
 EIS95 IS-95+EQUALIZER

Example: :SOUR:IS95:FILT:FTYP COS \*RST value is IS95

**[:SOURce]:IS95:FILTer:RTYPE** SCOSine | COSine | IS95 | EIS95 | USER

The command selects the type of filter for the Reverse Link Mode. A filter list should be selected with :IS95:FILT:SEL 'name' for the filter type USER.

SCOSine Square root cosine (root Nyquist) filter  
 COSine Cosine (Nyquist)-filter  
 IS95 Filter according to Interim Standard 95  
 EIS95 IS-95+EQUALIZER

Example: :SOUR:IS95:FILT:RTYP COS \*RST value is IS95

**[:SOURce]:IS95:FILTer:FSElect** 'name'

The command selects a named filter list. The list is used only if a user-defined filter is selected with :IS95:FILT:FTYPE USER. To generate lists, cf. command [:SOURce]:DM:FLIST:SEL, to fill up lists, cf. command [:SOURce]:DM:FLIST:DATA.

Example: :SOUR:IS95:FILT:FSEL 'test' \*RST value is NONE

**[:SOURce]:IS95:FILTer:RSElect** 'name'

The command selects a named filter list. The list is used only if a user-defined filter is selected with :IS95:FILT:RTYPE USER. To generate lists, cf. command [:SOURce]:DM:FLIST:SEL, to fill up lists, cf. command [:SOURce]:DM:FLIST:DATA.

Example: :SOUR:IS95:FILT:RSEL 'test' \*RST value is NONE

**[:SOURce]:IS95:FILTer:PARAMeter** 0.1 to 0.7

The command sets the roll-off factor for the COS filters.

Example: :SOUR:IS95:FILT:PAR 0.5 \*RST value is 0.5

**[:SOURce]:IS95:FILTer:MODE** LACP | LEVM

This command selects one of the "L"ow filter modes.

Example: :SOUR:IS95:FILT:MODE LEVM \*RST value is LACP

**[:SOURce]:IS95:LDISortion[:STATe]** ON | OFF

The command sets the reduced level for the low-distortion mode.

ON Low-distortion mode  
 OFF Normal level

Example: :SOUR:IS95:LDIS ON \*RST value is OFF

**[:SOURce]:IS95:SEQuence** AUTO | RETRigger | AAUTO | ARETrigger

The command selects the trigger mode for the sequence..

AUTO                   Continuously repeated

RETRigger           Continuously repeated; new start after a trigger

AAUTO                ARMED AUTO; waits for trigger, then switches over to AUTO and can no longer be triggered;

ARETrigger           ARMED RETRIG; a trigger event is required to start, each new trigger causes a restart

Example:     :SOUR:IS95:SEQ AAUT                                   \*RST value is AUTO

**[:SOURce]:IS95:TRIGger:SOURce** EXTernal | INTernal

The command selects the trigger source. With INT selected, triggering is via remote control using the trigger command or via EXECUTE TRIGGER in case of manual control.

EXT                   The trigger signal is fed in via input TRIGIN

INT                   A start is only possible manually or via the remote control command TRIG:DM:IMM

Example:     :SOUR:IS95:TRIG:SOUR EXT                           \*RST value is INT

**[:SOURce]:IS95:TRIGger:INHibit** 0 to 67108863

The command sets the retrigger inhibit duration (in number of chips).

Example:     :SOUR:IS95:TRIG:INH 1000                           \*RST value is 0

**[:SOURce]:IS95:TRIGger:DELay** 0 to 65535

The command defines the trigger delay (in number of chips).

Example:     :SOUR:IS95:TRIG:DEL 200                            \*RST value is 0

**[:SOURce]:IS95:TRIGger:OUTPut[1]2** TFRame | SSRollover | SFRame | ESECond | GATE

The command defines the output signal at trigger output 1 or 2. The following times can be selected:

TFRame               Traffic Frame/ 20 ms

SSRollover           Short Sequence Rollover 80/3 ms

SFRame               Super Frame 80 ms

ESECond              Even Second 2 s

GATE                  GATE (PCG)

The indicated times apply to a chip rate of 1.2288 Mcps

Example:     :SOUR:IS95:TRIG:OUTP1 SFR                         output1: \*RST value is ESECond  
   output2: \*RST value is SSRollover

**[:SOURce]:IS95:TRIGger:OUTPut[1]2:DELay** -32768 to 32768

The command defines the delay of trigger signals in chips.

Example:     :SOUR:IS95:TRIG:OUTP2:DEL -50                    \*RST value is 0

**[:SOURce]:IS95:TRIGger:OUTPut[1]2:POLarity** POSitive | NEGative

The commands defines the polarity of the signals at the trigger outputs.

Example:     :SOUR:IS95:TRIG:OUTP2:POL NEG                    \*RST value is POS

**[[:SOURce]:IS95:CLOCK**

The commands for setting the chip clock are under this node.

**[[:SOURce]:IS95:CLOCK:MODE CHIP | CHIP4 | CHIP8 | CHIP16**

The command sets the divider for the clock. With CHIP selected, the external clock is in the symbol mode, otherwise in the bit mode.

Example: `:SOUR:IS95:CLOC:MODE CHIP8` \*RST value is CHIP

**[[:SOURce]:IS95:CLOCK:SOURce INTERNAL | EXTERNAL**

The command selects the clock source.

INTERNAL The internal clock generator is used and output via clock outputs SYMBOL CLOCK and BIT CLOCK.

EXTERNAL The clock is fed externally via connector SYMBOL CLOCK.

Example: `:SOUR:IS95:CLOC:SOUR EXT` \*RST value is INT

**[[:SOURce]:IS95:CLOCK:DELay 0 to 1.00**

The command sets the delay of the chip clock with a high resolution.

Example: `:SOUR:IS95:CLOC:DEL 0.75` \*RST value is 0

**[[:SOURce]:IS95:POWER?**

The command queries the total power for the CDMA signal.

Example: `:SOUR:IS95:POW?`

**[[:SOURce]:IS95:POWER:ADJust**

The command modifies the power of each active code channel. This means that the total power is set equal to the power in the level display. The command triggers an action and hence has no \*RST value assigned.

Example: `:SOUR:IS95:POW:ADJ`

**[[:SOURce]:IS95:MAPPING**

The command for storing and reading the complete channel assignments and settings are under this node. These mappings are not affected by \*RST.

**[[:SOURce]:IS95:MAPPING:PREDefined:CATalog?**

The command returns a list of all predefined mappings.

Example: `:SOUR:IS95:MAPP:PRED:CAT?`

**[[:SOURce]:IS95:MAPPING:PREDefined:LOAD 'name'**

The command selects one of the predefined channel configurations (c.f. Chapter 2). This command triggers an event and hence has no \*RST value.

Example: `:SOUR:IS95:MAPP:SEL 'PILOT'`

**[[:SOURce]:IS95:MAPPING:CATalog?**

The command returns an enumerated list of all user-defined mappings.

Example: `:SOUR:IS95:MAPP:CAT?` Answer: 'test1', 'test2'

**[[:SOURce]:IS95:MAPPING:LOAD 'name']**

The command loads a user-defined channel assignment and setting (mapping). The name may have a maximum of 7 characters. This command triggers an action and hence has no \*RST value.

Example: :SOUR:IS95:MAPP:LOAD 'test'

**[[:SOURce]:IS95:MAPPING:STORE 'name']**

The command stores the current mapping under a name. The name may have a maximum of 7 characters. This command triggers an action and hence has no \*RST value and no query.

Example: :SOUR:IS95:MAPP:STOR 'test'

**[[:SOURce]:IS95:MAPPING:DELETE 'name']**

The command deletes the indicated mapping. This command triggers an action and hence has no \*RST value and no query.

Example: :SOUR:IS95:MAPP:DEL 'test1'

**[[:SOURce]:IS95:CHANNEL<0 to 63>]**

The commands for specifying the channel configuration for the 18-channel Forward Link (channel 0 to 17) and 64-channel Forward Link (channel 0 to 63) are under this node. Channel 0 for which only the power can be set is the pilot channel.

**[[:SOURce]:IS95:CHANNEL<1 to 17>:WALSHcode 0 to 63]**

This command assigns a Walsh code to a channel. This applies to FLINK18 only; for FLINK64, the Walsh code corresponding to its channel number is assigned to every channel. The command is not available in this case.

Example: :SOUR:IS95:CHAN2:WALS 23

**[[:SOURce]:IS95:CHANNEL<0 to 3>:POWER -30 dB to 0 dB]**

This command determines the power of a channel. For Flink18 the power for channels 0, 1 and 2 can be set separately. The power setting for channel 3 is also valid for the subsequent channels. For Flink64 the power setting for channel 1 is valid for all subsequent channels (except for the pilot channel)

Example: :SOUR:IS95:CHAN2:POW -22 DB

**[[:SOURce]:IS95:CHANNEL<1 to 63>:DATA ZERO | ONE | ALTERNATE | PRBS]**

This command determines the data source of the channel.

ZERO 0000..., sequence of zeros

ONE 1111..., sequence of ones

ALT 1010..., alternating sequence, starting with 1

PRBS Pseudo Random Bit sequence

Example: :SOUR:IS95:CHAN2:DATA PRBS

**[[:SOURce]:IS95:CHANNEL<0 to 63>:STATE ON | OFF]**

The command switches the channel on or off.

Flink18: channels 0 to 8 are switched on and channels 9 to 17 are switched off.

Flink64: all channels are switched on.

Example: :SOUR:IS95:CHAN17:STAT ON

\*RST value: see text



**[[:SOURce]:IS95:RATE FULL | HALF**

The command sets the data rate for operating mode Reverse Link (IS95:MODE RLINK).

Example: :SOUR:IS95:RATE HALF \*RST value is FULL

**[[:SOURce]:IS95:RANDomizer[:STATe] ON | OFF**

The command switches the burst randomizer for operating mode Reverse Link (IS95:MODE RLINK) on or off. The bursts are distributed at pseudo random within a 20-ms frame.

Example: :SOUR:IS95:RAND ON \*RST value is OFF

**[[:SOURce]:IS95:DATA ZERO | ONE | ALTeRNate | PRBS | DLIS**

This command determines the data source for operating mode Reverse Link (IS95:MODE RLINK).

ZERO 0000..., sequence of zeros

ONE 1111..., sequence of ones

ALT 1010..., alternating sequence, starting with 1

PRBS Pseudo Random Bit Sequence

DLIS The data list selected with IS95:DLIS 'name' is used.

Example: :SOUR:IS95:DATA ZERO \*RST value is PRBS

**[[:SOURce]:IS95:DLIS 'name'**

The command selects a data list. This list is used if DLIS is selected as the data source (IS95:DATA DLIS).

Example: :SOUR:IS95:DLIS 'test'

**[[:SOURce]:IS95:DLIS:CATalog?**

The command queries the available data lists. (Only query, no \*RST value)

Example: :SOUR:IS95:DLIS:CAT?

**[[:SOURce]:IS95:RLCoded:CTYPe TRAF14400 | TRAF7200 | TRAF3600 | TRAF1800 | ACC4800 | TRAF9600 | TRAF4800 | TRAF2400 | TRAF1200**

The command defines the data rate and the channel type. It is only available with 'IS95:MODE RLCoded' selected.

Example: :SOUR:IS95:RLC:CTYP TRAF1800 \*RST value is TRAF14400

**[[:SOURce]:IS95:RLCoded:DATA PN9 | PN11 | PN15 | PN 16 | PN20 | PN21 | PN23 | DLIS**

The command selects the data source. PN.. represent the PRBS generators, DLIS the data list selected with the following command. The command is only available with 'IS95:MODE RLCoded' selected.

Example: :SOUR:IS95:RLC:DATA DLIS \*RST value is PN9

**[[:SOURce]:IS95:RLCoded:DLIS 'name'**

The command selects a data list. This list is used if DLIS is selected as the data source. The command is only available with 'IS95:MODE RLCoded' selected.

Example: :SOUR:IS95:RLC:DLIS 'test'

**[[:SOURce]:IS95:RLCoded:FQINdicator ON | OFF**

The command switches the frame quality indicator (a CRC of the data) on or off. If the frame quality indicator is switched off, only zeros are transmitted. The command is only available with 'IS95:MODE RLCoded' selected.

Example: :SOUR:IS95:RLC:FQIN OFF \*RST value is ON

**[[:SOURce]:IS95:RLCoded:CENCoder ON | OFF**

The command switches the convolutional encoder on or off. If the convolutional encoder is off, the required data rate is attained by repeating the symbols. The command is only available with 'IS95:MODE RLCoded' selected.

Example: :SOUR:IS95:RLC:CENC OFF \*RST value is ON

**[[:SOURce]:IS95:RLCoded:BINterleaver ON | OFF**

The command selects the block interleaver function. It is only available with 'IS95:MODE RLCoded' selected.

Example: :SOUR:IS95:RLC:BINTE OFF \*RST value is ON

**[[:SOURce]:IS95:RLCoded:EBIT 0 | 1**

The command sets the value of the erasure bit. It is only available with 'IS95:MODE RLCoded' selected.

Example: :SOUR:IS95:RLC:EBIT 0 \*RST value is 1

### 3.5.14.12 SOURce:LIST Subsystem

This subsystem contains the commands for the LIST operating mode of the RF generator. The LIST mode is activated by command `SOURce:FREQuency:MODE LIST`. Processing the lists is controlled by the `TRIGger:LIST` subsystem. Each list consists of a `FREQuency`, `POWER` and `DWELI` content. The list contents must all be of the same length except for contents of length 1. This is interpreted as if the content had the same length as the other contents and all values were equal to the first value. After a list has been created and changed, command `:LIST:LEARn` has to be entered to have the settings transferred to the hardware.

**Note:** SCPI designates the individual lists as segments.

Command	Parameter	Default unit	Remark
<code>[[:SOURce]]</code>			
<code>:LIST</code>			
<code>:CATalog?</code>	$\Rightarrow$ name {,name}...		Query only
<code>:DELeTe</code>	'Name of list'		
<code>:ALL</code>			
<code>:DWELI</code>	1 ms to 1 s	s	
<code>:FREE?</code>			Query only
<code>:FREQuency</code>	300 kHz to $RF_{max}$ {, 300 kHz to $RF_{max}$ }   block data	Hz	$RF_{max}$ : depends on model
<code>:POINTs?</code>			Query only
<code>:LEARn</code>			No query
<code>:MODE</code>	AUTO   STEP		
<code>:POWer</code>	-144 to 16 dBm {, -144 to 16 dBm }   block data	dBm	
<code>:POINTs?</code>			
<code>:SELeCt</code>	'Name of list'		Query only

#### `[[:SOURce]]:LIST:CATalog?`

The command requests a list of the lists available separated by commas. The command is a query and hence has no \*RST value.

Example: `:SOUR:LIST:CAT?` Answer: 'MYLIST', 'LIST1', 'LIST2'

#### `[[:SOURce]]:LIST:DELeTe` 'Name of list'

The command deletes the list indicated. \*RST has no influence on data lists.

Example: `:SOUR:LIST:DEL 'LIST2'`

#### `[[:SOURce]]:LIST:DELeTe:ALL`

The command deletes all lists. As a possibly selected list is deleted as well, the LIST mode must be switched off (`SOURce:FREQuency:MODE CW` or `SWEep`). \*RST has no influence on data lists.

Example: `:SOUR:LIST:DEL:ALL`

#### `[[:SOURce]]:LIST:DWELI` 1 ms to 1 s

The command sets the time the instrument 'dwells' at this item.

Example: `:SOUR:LIST:DWEL 0.15`

#### `[[:SOURce]]:LIST:FREE?`

The command queries two values. The first one indicates the space still vacant for lists, the second one the space already occupied (in items). The command is a query and thus has no \*RST value.

Example: `:SOUR:LIST:FREE?` Answer: 2400, 200

**[[:SOURCE]:LIST:FREQUENCY** 300 kHz to  $RF_{max}$  {, 300 kHz to  $RF_{max}$ } | block data  
( $RF_{max}$  depending on model)

The command fills the FREQUENCY part of the list selected with data. The data can either be indicated as a list of numbers (separated by commas) of arbitrary length or as binary block data. In the case of block data transmission, always 8 (4) bytes are interpreted as a floating-point number of double accuracy (cf. command `FORMAt :DATA`). \*RST does not influence data lists.

Example: `:SOUR:LIST:FREQ 1.4GHz, 1.3GHz, 1.2GHz,...`

**[[:SOURCE]:LIST:FREQUENCY:POINTS?**

The command queries the length (in items) of the FREQUENCY part of the list presently selected. The command is a query and thus has no \*RST value.

Example: `:SOUR:LIST:FREQ:POIN?` Answer: 327

**[[:SOURCE]:LIST:LEARN**

The command learns the list selected. I.e., it determines the hardware setting for the entire list. The data thus determined are stored together with the list. The command triggers an event and thus has no \*RST value.

Example: `:SOUR:LIST:LEAR`

**Caution:** *This command has to be given after every creating and changing of a list.*

**[[:SOURCE]:LIST:MODE** AUTO | STEP

The command indicates the mode in which the list is to be processed (by analogy with `SOURCE:SWEep:MODE`).

AUTO Each trigger event triggers a complete list run.

STEP Each trigger event triggers only one step in processing the list.

Example: `:SOUR:LIST:MODE STEP` \*RST value is AUTO

**[[:SOURCE]:LIST:POWER** -144 to 16 dBm {, -144 to 16 dBm} | block data

The command fills the LEVEL part of the RF list selected with data. The data can either be indicated as a list of numbers (separated by commas) of arbitrary length or as binary block data. As to the format of the data, cf. command `:SOURCE:LIST:FREQ`. \*RST does not influence data lists.

Example: `:SOUR:LIST:POW 0dBm, -2dBm, -2dBm, -3dBm,...`

**[[:SOURCE]:LIST:POWER:POINTS?**

The command queries the length (in items) of the LEVEL part of the list presently selected. The command is a query and thus has no \*RST value

Example: `:SOUR:LIST:POW:POIN?` Answer: 32

**[[:SOURCE]:LIST:SElect** 'Name of list

The command selects the list indicated. If there is no list of this name, a new list is created. The name may contain up to 8 letters. The command triggers an event and thus has no \*RST value

Example: `:SOUR:LIST:SEL 'LIST1'`

### 3.5.14.13 SOURce:MARKer Subsystem

This subsystem contains the commands to check the marker generation with sweeps. The SMIQ has three markers each for frequency and level sweeps which are differentiated by a numeric suffix after MARKer. The settings for frequency sweep and level sweep marker are independent of each other.

Command	Parameter	Default Unit	Remark
[[:SOURce] :MARKer1 2 3 4 [:FSweep]			
:AMPLitude	ON   OFF		No query
:AOFF			RF <sub>max</sub> depending on model
:FREquency	300 kHz to RF <sub>max</sub>	Hz	
[:STATe]	ON   OFF		
:PSweep			No query
:AOFF			
:POWER	-144 to+16 dBm	dBm	
[:STATe]	ON   OFF		
:POLarity	NORMal   INVerted		

#### [[:SOURce]:MARKer1|2|3|4[:FSweep]

The commands for the markers with frequency sweep are under this node. Keyword :FSweep can be omitted, then the command conforms to SCPI regulations.

#### [[:SOURce]:MARKer1|2|3|4[:FSweep]:AMPLitude ON | OFF

The command specifies whether the marker influences the signal level.

ON The output level is reduced by a constant value when the marker frequency is executed.

OFF The output level remains unchanged. \*RST value is OFF

Example: :SOUR:MARK1:FSW:AMP ON

#### [[:SOURce]:MARKer1|2|3|4[:FSweep]:AOFF

Command (All markers off) switches off all frequency markers. This command triggers an event, thus it has no \*RST value and no query form.

Example: :SOUR:MARK:FSW:AOFF

#### [[:SOURce]:MARKer1|2|3[:FSweep]:FREquency 300 kHz to RF<sub>max</sub> (RF<sub>max</sub> depending on model)

The command sets the marker selected by the numeric suffix with MARKer to the frequency indicated.

In this command, the OFFSet value of the subsystem (menu) FREquency is considered as with input value MARKer in the SWEEP-FREQ menu. Thus the specified range indicated is only valid for SOURce:FREquency:OFFSet = 0. The specified range with other OFFSet values can be calculated according to the following formula (cf. Chapter 2, Section "Frequency Offset", as well):

300 kHz - OFFSet to RF<sub>max</sub> - OFFSet \*RST value for MARK1: 100 MHz  
 MARK2: 200 MHz  
 MARK3: 300 MHz  
 MARK4: 400 MHz

Example: :SOUR:MARK1:FSW:FREQ 30MHz

**[[:SOURce]:MARKer1|2|3|4[:FSweep][:STATe] ON | OFF**

The command switches the marker selected by the numeric suffix with MARKer on or off.

Example: `:SOUR:MARK1:FSW:STAT ON` \*RST value is OFF

**[[:SOURce]:MARKer1|2|3|4:PSweep**

The commands for the markers with level sweep are under this node (Power sweep). The three markers are differentiated by a numeric suffix after MARKer.

**[[:SOURce]:MARKer1|2|3|4:PSweep:AOff**

The command switches all level markers off. This command is an event and thus has no \*RST value and no query form.

Example: `:SOUR:MARK:PSW:AOff`

**[[:SOURce]:MARKer1|2|3|4:PSweep:POWer -144 dBm to +16 dBm**

The command sets the marker selected by the numeric suffix with MARKer to the level indicated.

In this command, the OFFSet value of subsystem (menu) POWER (LEVEL) is considered in correspondence with input value MARKer in the SWEEP LEVEL menu. Thus the specified range indicated is only valid for `SOURce:POWer:OFFSet = 0`. The specified range with other OFFSet values can be calculated according to the following formula (cf. Chapter 2, Section "Level Offset" as well):

-144 dBm OFFSet to 16 dBm OFFSet	*RST value for MARK1: 1 dBm
	MARK2: 2 dBm
	MARK3: 3 dBm
	MARK4: 4 dBm

Example: `:SOUR:MARK1:PSW:POW -2dBm`

**[[:SOURce]:MARKer1|2|3:PSweep[:STATe] ON | OFF**

The command switches the marker selected by the numeric suffix with MARKer on or off.

Example: `:SOUR:MARK1:PSW:STAT ON` \*RST value is OFF

**[[:SOURce]:MARKer1|2|3:POLarity NORMal | INVerted**

The command specifies the polarity of the marker signal.

**NORMal** When running through the marker condition, TTL level is applied at the marker output, otherwise 0 V.

**INVerted** When running through the marker condition, 0 V is applied at the marker output, otherwise TTL level. \*RST value is NORM

Example: `:SOUR:MARK:POL INV`

**3.5.14.14 SOURce:MODulation Subsystem**

Command	Parameter	Default unit	Remark
[:SOURce] :MODulation [:ALL] :STATe	ON   OFF		

**[:SOURce]:MODulation[:ALL]:STATe ON | OFF**

This command deactivates all types of modulation with OFF. All analog, vector, digital, digital standard and ARB modulations are thus set to OFF if they were switched on before. This command can be used before switching on a new type of modulation in order to avoid the error message "settings conflict" since only one type of modulation can be operated at the same time. The modulation used last is activated again with ON (same function as MOD ON/OFF key).

This command triggers an event and hence has no \*RST value and no query.

Example:     :SOUR:MOD:STAT OFF

## 3.5.14.15 SOURce:NADC Subsystem

**Note** #H0 to #HF are characters which are entered in alphanumeric Hex form manually. SCPI (and IEEE 488.2) also accept the entry of non-decimal characters in octal and binary such as  
 #H|h <0 to 9, A|a to F|f>,  
 #Q|q <0 to 7> and  
 #B|b <0|1>.  
 The characters are always output in Hex format after a query.

Command	Parameter	Default unit	Remark
[:SOURce]			
:NADC			
:STATe	ON   OFF		
:STANdard	-		No query
:SRATe	1kHz to 200 kHz	Hz	
:FILTer			
:TYPE	SCOSine   COSine   USER		
:SELEct	'name'		
:PARAmeter	0.1 to 0.7		
:MODE	LACP   LEVM		
:LDISortion			
[:STATe]	ON   OFF		
:SEQuence	AUTO   RETRigger   AAUTO   ARETrigger		
:TRIGger			
:SOURce	EXTernal   INTernal		
:INHibit	0 to 67.1E6		
:DELay	0 to 65535		
:OUTPut[2]	SLOT   FRAME		
:DELay	0 to 971		
:PERiod	1 to 67.1E6		
:CLOCK			
:SOURce	INTernal   EXTernal		
:MODE	BIT   SYMBol		
:DELay	0 to 1.0		no query
:PRAMp			
:PRESet			
:TIME	0.25 to 16		
:DELay	-1,0 to +1,0		
:SHAPE	LINear   COSine		
:ROFFset	-9 to +9		
:FOFFset	-9 to +9		
:SLOT			
:ATTenuation	0 to 70 dB	dB	
:LINK	UP   DOWN		
:RCONfiguration	AHALf   FULL1   FULL2   FULL3   FULL12   FULL13   FULL23   AFULI		



Command	Parameter	Default unit	Remark
[:SOURce] :NADC :FLISt :PREDeFined :CATalog? :LOAD :CATalog? :LOAD :STORe :DELeTe :DLISt :CATalog? :SLOT<i> :TYPE :LEVel :PRESet [:SOURce] :SACChannel :DLISt :DATA :DLISt :SYNC :CDVCc :RSVD	   => name {,name}... 'name' => name {,name}... 'name' 'name' 'name' => name {,name}... TCH   SHORt   ADATa OFF   ATT   FULL - PN9   PN11  PN15   PN 16   PN20   PN21   PN23   DLISt   SDATa 'name' PN9   PN11  PN15   PN 16   PN20   PN21   PN23   DLISt   SDATa 'name' #H0 to #HFFFFFF (28 bit) #H1 to #HFFF ( 8 bit) #H800 to #HFFF ( 12/11 bit)		   query only query only no query no query query only i=[1],2 to 8 (Slot Selector)  no query

**[:SOURce]:NADC:STATe ON | OFF**

The command switches the modulation on according to NADC standard. All other standards that might be switched on or digital modulation are automatically switched OFF.

Example: :SOUR:NADC:STAT ON \*RST value is OFF

**[:SOURce]:NADC:STANdard**

The commands sets all modulation parameters to the values of the NADC standard. I.e., all values that have been selected by the :NADC:SLOT... commands described in the following are not valid. This command triggers an event and hence has no \*RST value and no query.

Example: :SOUR:NADC:STAN

**[:SOURce]:NADC:SRATe 1kHz to 200 kHz**

The command sets the symbol rate.

Example: :SOUR:NADC:SRAT 192.1 kHz \*RST value is 192 kHz

**[:SOURce]:NADC:FILTer**

The commands for selecting a filter are under this node.

**[ :SOURCE]:NADC:FILTer:TYPE** SCOSine | COSine | USER

The command selects the type of filter. A filter list should be selected with :NADC:FILT:SEL 'name' for the filter type USER.

Example: :SOUR:NADC:FILT:TYPE COS \*RST value is SCOS

**[ :SOURCE]:NADC:FILTer:SElect** 'name'

The command selects a named filter list. The list is used only if a user-defined filter is selected with :NADC:FILT:TYPE USER. To generate lists, cf. command [:SOURCE]:DM:FLIST:SEL, to fill up lists, cf. command [:SOURCE]:DM:FLIST:DATA.

Example: :SOUR:NADC:FILT:SEL 'test' \*RST value is NONE

**[ :SOURCE]:NADC:FILTer:PARAmeter** 0.1 to 0.7

The command sets the filter parameter entry (Roll Off factor).

Example: :SOUR:NADC:FILT:PAR 0.5 \*RST value is 0.35

**[ :SOURCE]:NADC:FILTer:MODE** LACP | LEVM

This command selects one of the "L"ow filter modes.

Example: :SOUR:NADC:FILT:MODE LEVM \*RST value is LACP

**[ :SOURCE]:NADC:LDisortion[:STATE]** ON | OFF

The command sets the reduced level for the low-distortion mode.

Example: :SOUR:NADC:LDIS ON \*RST value is OFF

**[ :SOURCE]:NADC:SEquence** AUTO | RETRigger | AAUTo | ARETrigger

The command selects the trigger mode for the sequence.

AAUTo is ARMED AUTO

ARETrigger is ARMED RETRIG

Example: :SOUR:NADC:SEQ AAUT \*RST value is AUTO

**[ :SOURCE]:NADC:TRIGger:SOURce** EXTernal | INTernal

The command selects the trigger source. With INT selected, triggering is via IEC/IEEE bus or the Execute command in manual control.

Example: :SOUR:NADC:TRIG:SOUR EXT \*RST value is INT

**[ :SOURCE]:NADC:TRIGger:INHibit** 0 to 67.1E6

The command sets the retrigger inhibit duration (in number of symbols).

Example: :SOUR:NADC:TRIG:INH 1000 \*RST value is 0

**[ :SOURCE]:NADC:TRIGger:DELay** 0 to 65535

The command sets the trigger delay (in number of symbols).

Example: :SOUR:NADC:TRIG:DEL 200 \*RST value is 0

**[:SOURce]:NADC:TRIGgerOUTPut[2]:DELay 0 to 971**

The command determines the delay of the signal at trigger output 2 in comparison with the start of the frames/slots in number of symbols.

Example: `:SOUR:NADC:TRIG:OUTP2:DEL 16` \*RST value is 0

**[:SOURce]:NADC:TRIGger:OUTPut[2]:PERiod 1 to 67.1E6**

The command sets the repeat rate (in number of frames) of the signal at trigger output 2.

Example: `:SOUR:NADC:TRIG:OUTP2:PER 8` \*RST value is 1

**[:SOURce]:NADC:CLOCK**

The commands for setting the data clock are under this node.

**[:SOURce]:NADC:CLOCK:SOURce INTernal | EXTernal**

The command selects the source for the DM data clock.

**INTernal** The internal clock generator is used and output via the clock outputs of the serial and parallel interface.

**EXTernal** The clock is externally fed in via the serial interface and output via the parallel interface.

Example: `:SOUR:NADC:CLOC:SOUR INT` \*RST value is INT

**[:SOURce]:NADC:CLOCK:MODE BIT | SYMBol**

The command sets the clock mode for `:NADC:CLOCK:SOURce EXTernal`.

**BIT** The external clock has to be a bit clock.

**SYMBol** The external clock has to be a symbol clock.

The bit and symbol clock only differ for this modulation, because it has more than two states, i.e. more than one bit is required to code each state.

Example: `:SOUR:NADC:CLOC:MODE BIT` \*RST value is SYMB

**[:SOURce]:NADC:CLOCK:DELay 0 to 1.0**

The command sets the delay of the symbol clock (as a fraction of the length of a symbol).

Example: `:SOUR:NADC:CLOC:DEL 0.75` \*RST value is 0

**[:SOURce]:NADC:PRAMP**

The commands for the level control of the burst are under this node.

**[:SOURce]:NADC:PRAMP:PRESet**

This command sets the standard-stipulated values for the following commands of level control. It is an event and hence has no query and no \*RST value.

Example: `:SOUR:NADC:PRAM:PRES`

**[:SOURce]:NADC:PRAMP:TIME 0.25 to 16.0**

The command sets the cutoff steepness (in symbol clocks).

Example: `:SOUR:NADC:PRAM:TIME 2.5` \*RST value is 3

**[:SOURce]:NADC:PRAMP:DELay -1.0 to + 1.0**

The command defines the shift of the envelope characteristic to the modulated signal. A positive value causes a delay of the envelope.

Example: `:SOUR:NADC:PRAM:DEL 0.2` \*RST value is 0

#### **[[:SOURce]:NADC:PRAMP:SHAPE LINear | COSine**

The command selects the linear or cosine shape of the ramp-up and ramp-down (power burst).

Example: `:SOUR:NADC:PRAM:SHAP COS` \*RST value is COS

#### **[[:SOURce]:NADC:PRAMP:ROFFset -9 to +9**

The command determines the timing of the ('R'ising) edge of a power burst to the beginning of the block.

Example: `:SOUR:NADC:PRAM:ROFF -3` \*RST value is 0

#### **[[:SOURce]:NADC:PRAMP:FOFFset -9 to +9**

The command determines the timing of the ('F'alling) edge of a power burst to the data block

Example: `:SOUR:NADC:PRAM:FOFF 4` \*RST value is 0

#### **[[:SOURce]:NADC:SLOT:ATTenuation 0 to -70 dB**

The command determines the amount by which the power of the slots marked by `:NADC:SLOT:LEVEL ATT` is reduced in comparison with the normal output power (attribute to `:LEVEL FULL`).

Example: `:SOUR:NADC:SLOT:ATT 20 dB` \*RST value is 0

#### **[[:SOURce]:NADC:LINK UP | DOWN**

The command determines the burst type which differs depending on the transmit direction. The structure of the frames is different and thus has an effect on the selection of possible `:NADC:SLOT` commands. This command is stored as a part of the `:NADC:FLIST` configurations described below.

UP From mobile part to fixed part

DOWN From fixed part to mobile part

Example: `:SOUR:NADC:LINK DOWN` \*RST value is DOWN

#### **[[:SOURce]:NADC:RCONfiguration AHALf | FULL1 | FULL2 | FULL3 | FULL12 | FULL13 | FULL23 | AFUL**

This configuration setup determines how the FULL- and HALF-rate channels (slots) are distributed among the frames. This command is stored as a part of the `:NADC:FLIST` configurations described below.

AHALf All Half

FULL1 FULL (1 & 4)

FULL2 FULL (2 & 5)

FULL3 FULL (3 & 6)

FULL12 FULL (1 & 4), (2 & 5)

FULL13 FULL (1 & 3), (3 & 6)

FULL23 FULL (2 & 5), (3 & 6)

AFUL All Full

Example: `:SOUR:NADC:RCON FULL3` \*RST value is AFUL

#### **[[:SOURce]:NADC:FLIST**

The commands for storing and reading complete frames including their bursts (slots) are under this node. Predefined and user-generated frames have to be distinguished.

**[ :SOURce]:NADC:FLIS:PREDefined:CATalog?**

The command returns a list of all predefined frames.

Example: `:SOUR:NADC:FLIS:PRED:CAT?`

**[ :SOURce]:NADC:FLIS:PREDefined:LOAD 'name'**

The command selects one of the predefined (fixed) frames (c.f. Chapter 2). This command triggers an event and hence has no \*RST value and no query.

Example: `:SOUR:NADC:FLIS:PRED:LOAD 'test'`

**[ :SOURce]:NADC:FLIS:CATalog? =>name, {name}...**

The command returns a list of all user-defined frames.

Example: `:SOUR:NADC:FLIS:CAT?`

**[ :SOURce]:NADC:FLIS:LOAD 'name'**

The command loads a user-defined frame. This command triggers an event and hence has no \*RST value and no query.

Example: `:SOUR:NADC:FLIS:LOAD 'dn_tch'`

**[ :SOURce]:NADC:FLIS:STORE 'name'**

The command stores the current frame under a name. This command triggers an event and hence has no \*RST value and no query.

Example: `:SOUR:NADC:FLIS:STOR 'test'`

**[ :SOURce]:NADC:FLIS:DELeTe 'name'**

The command deletes the indicated frame. This command triggers an event and hence has no \*RST value and no query.

Example: `:SOUR:NADC:FLIS:DEL 'test1'`

**[ :SOURce]:NADC:DLIS:CATalog?**

The command returns an enumeration of all data lists.

These data lists are selected by means of `:NADC:SLOT:SACC:DLIS 'name'` and `...:DATA:DLIS 'name'` and used if `:NADC:SLOT:SACC DLIS` and `...:DATA DLIS` are set.

Example: `:SOUR:NADC:DLIS:CAT?`

**[ :SOURce]:NADC:SLOT<i>**

The commands for setting the slot characteristics are under this node. Since a frame contains 6 slots, suffix 'i' is used to select the slot to be changed.  $i = [1] | 2 | 3 | 3 | 5 | 6$

**[ :SOURCE ]:NADC:SLOT<i>:TYPE TCH | SHORT | ADATa**

The command selects the type of burst (slot) defined in the standard.

TCH Normal communication channel with the fields defined by the standard.

ADATa All data (without predefined SYNC, SACCh, CDVCC and RSVD fields)

SHORT Only used for uplink to set up TCH.

Example: :SOUR:NADC:SLOT2:TYPE TCH \*RST value is TCH

**[ :SOURCE ]:NADC:SLOT<i>:LEVeL OFF | ATT | FULL**

The command determines the power stage of the slot.

OFF The slot is inactive.  
For UPLINK, the source is always at full power. Therefore, in the case of a DOWNLINK TCH burst, only a series of 1's is sent instead of the data.

ATT The power is reduced by the amount defined by :NADC:SLOT:ATT  
For a DOWNLINK TCH burst this setting is not valid.

FULL Full power (predefined by level setting)

Example: :SOUR:NADC:SLOT2:LEV ATT \*RST value is FULL

**[ :SOURCE ]:NADC:SLOT<i>:PRESet**

The command sets all the parameters of the slot to the values defined by the standard as a function of the type set above and the direction (LINK). This command triggers an event and hence has no \*RST value and no query.

Example: :SOUR:NADC:SLOT2:PRES

**[ :SOURCE ]:NADC:SLOT<i>[:SOURCE]**

The commands for determining the source for the data contents are under this node. The source is either a PRBS generator (with different sequence length), the data input SER DATA or a data list.

Selection of data source for the data fields of the burst:

PN9 to 23 PRBS generator has been selected

DLIS Data of a programmable data list

SDATa Data from data input SER DATA

**[ :SOURCE ]:NADC:SLOT<i>[:SOURCE]:SACChannel PN9 | PN11 | PN15 | PN16 | PN20 | PN21 | PN23 | DLIS | SDATa**

The command determines the data source for the data words.

Example: :NADC:SLOT3:SACC PN15 \*RST value is PN9

**[ :SOURCE ]:NADC:SLOT<i>[:SOURCE]:SACChannel:DLIS 'name'**

The command selects a data list. This list will not be used unless it is set as a data source by means of the :NADC:SLOT:SACC DLIS command. This command triggers an event and hence has no \*RST value.

Example: :NADC:SLOT:SACC:DLIS 'test'

**[ :SOURCE ]:NADC:SLOT<i>[:SOURCE]:DATA PN9 | PN11 | PN15 | PN16 | PN20 | PN21 | PN23 | DLIS | SDATa**

The command determines the data source for the data words.

Example: :SOUR:NADC:SLOT2:DATA DLIS \*RST value is PN9

**[:SOURce]:NADC:SLOT<i>[:SOURce]:DATA:DLIS 'name'**

The command selects a data list. This list will not be used unless it is set as a data source by means of the :NADC:SLOT:DATA DLIS command. This command triggers an event and hence has no \*RST value.

Example: :NADC:SLOT:DATA:DLIS 'test'

**[:SOURce]:NADC:SLOT<i>:SYNC #H0 to #FFFFFFF (28 bit)**

The command changes the sync word predefined by the standard.

Example: :SOUR:NADC:SLOT2:SYNC #HC7E3C0C \*RST value depends on SLOT:TYPE

**[:SOURce]:NADC:SLOT<i>:CDVCC #H1 to #HFFF (8 bit)**

This command sets the Coded Digital Verification Color Code.

Example: :SOUR:NADC:SLOT2:CDVCC #H3F \*RST value is 1

**[:SOURce]:NADC:SLOT<i>:RSVD #H800 to #HFFF (12/11 bit)**

The command sets the reserved word (only for TCH and LINK DOWN). The MSBit is normally set.

Example: :SOUR:NADC:SLOT2:RSVD #H80F \*RST value is #H800

### 3.5.14.16 SOURce:NOISe Subsystem

Subsystem NOISe comprises all commands for setting the noise generator.

The NDSim subsystem under CALibrate is available for the offset calibration. In the DIAGnostic subsystem the noise or carrier signal can be switched off for C/N measurements (refer to chapter Performance Test in the Operating Manual).

Command	Parameter	Default Unit	Remark
[[:SOURce] :NOISe [:STATe] :SNRatio :BANDwidth BWIDth	ON   OFF -5.0 to 30.0 10k to 10M	 dB Hz	Not-SCPI

#### [[:SOURce]:NOISe[:STATe] ON | OFF

This command switches White Gaussian Noise on or off.

Example: :SOUR:NOIS ON

\*RST value is OFF

#### [[:SOURce]:NOISe:SNRatio -5.0 to 30.0 dB

This command sets the S/N ratio.

Setting range is -5 dB to +30 dB, resolution is 0.1 dB.

Example: :SOUR:NOIS:SNR 10 DB

\*RST value is 0 dB

#### [[:SOURce]:NOISe:BANDwidth|BWIDth 10000 to 10000000 Hz

This command sets the noise bandwidth. Setting range is 10 kHz to 10 MHz.

Example: :SOUR:NOIS:BAND 1.23 MHZ

\*RST value is 10 kHz



3.5.14.17 SOURce:PDC Subsystem

**Note:** #H0 to #HF are characters which are entered in alphanumeric Hex form manually. SCPI (and IEEE 488.2) also accept the entry of non-numeric characters in octal and binary such as #H|h <0 to 9, A|a to F|f>, #Q|q <0 to 7> and #B|b <0|1>. The characters are always output in Hex format after a query.

Command	Parameter	Default unit	Remark
[:SOURce]			
:PDC			
:STATe	ON   OFF		
:STANdard			
:SRATe	1kHz to 200 kHz	Hz	
:FILTer			
:TYPE	SCOSine   COSine   USER		
:SElect	'name'		
:PARAmeter	0.1 to 0.7		
:MODE	LACP   LEVM		
:LDISortion			
[:STATe]	ON   OFF		
:SEquence	AUTO   RETRigger   AAUto   ARETrigger		
:TRIGger			
:SOURce	EXTernal   INTernal		
:INHibit	0 to 67.1E6		
:DELay	0 to 65535		
:OUTPut[2]			
:DELay	0 to 839		
:PERiod	1 to 67.1E6		
:CLOCK			
:SOURce	INTernal   EXTernal		
:MODE	BIT   SYMBol		
:DELay	0 to 1.0		
:PRAMP			
:PRES			no query
:TIME	0.25 to 16		
:DELay	-1.0 to 1.0		
:SHAPE	LINear   COSine		
:ROFFset	-9 to +9		
:FOFFset	-9 to +9		
:SLOT			
:ATTenuation	0 to 70 dB	dB	
:LINK	UP   DOWN		
:RCONfiguration	AHALf   FULL0   FULL1   FULL2   FULL10   FULL20   FULL21   AFUL		

Command	Parameter	Default unit	Remark
[:SOURce]			
:PDC			
:FLISt			
:PREDefined			
:CATalog?			query only
:LOAD	⇒ name {,name}...		
:CATalog?	'name'		query only
:LOAD	'name'		
:STORe	'name'		no query
:DELeTe	'name'		no query
:DLISt	'name'		
:CATalog?			query only
:SLOT<i>			
:TYPE	TCH   SYNC   VOX   ADATa		
:LEVel	OFF   ATT   FULL		
:PRESet			No query
:SCRamble			
:STATe	ON   OFF		
:STARt	#H1 to #H1FF (9 bits)		
:SFRame			
:STATe	ON   OFF		
:RCHPosition	1 to 17		
[:SOURce]			
:DATA	PN9   PN11   PN15   PN16   PN20   PN21   PN23   DLISt   SDATa		
:DLISt	'name'		
:SACChannel	PN9   PN11   PN15   PN16   PN20   PN21   PN23   DLISt   SDATa		
:DLISt	'name'		
:RCHannel	PN9   PN11   PN15   PN16   PN20   PN21   PN23   DLISt   SDATa		
:DLISt	'name'		
:SI	PN9   PN11   PN15   PN16   PN20   PN21   PN23   DLISt   SDATa		
:DLISt	'name'		
:PREamble	#H0 to #HFF... (2/6/48/102 bits)		
:SYNC	#H0 to #HFF... (20/32 bits)		
:SYNC2	#H0 to #HFF... (20/32 bits)		
:CCODE	#H0 to #HFF (8 bits)		
:POSTamble	#H0 to #H3FF... (78 bits)		
:SF	0   1		

## [:SOURce]:PDC:STATe ON | OFF

The command switches the modulation on or off according to PDC standard. All other standards that might be switched on or digital modulation are automatically switched OFF.

Example: :SOUR:PDC:STAT ON

\*RST value is OFF

**[[:SOURce]:PDC:STANdard**

The commands sets all modulation parameters to the values of the PDC standard. I.e., all values that have been selected by the :PDC:SLOT... commands described in the following are not valid. This command triggers an event and hence has no \*RST value and no query.

Example: :SOUR:PDC:STAN

**[[:SOURce]:PDC:SRATe 1kHz to 200 kHz**

The command sets the symbol rate.

Example: :SOUR:PDC:SRAT 21.1 kHz \*RST value is 21.0 kHz

**[[:SOURce]:PDC:FILTer**

The commands for selecting a filter are under this node.

**[[:SOURce]:PDC:FILTer:TYPE SCOSine | COSine | USER**

The command selects the type of filter. A filter list should be selected with :PDC:FILT:SEL 'name' for the filter type USER.

Example: :SOUR:PDC:FILT:TYPE COS \*RST value is SCOS

**[[:SOURce]:PDC:FILTer:SELEct 'name'**

The command selects a named filter list. The list is used only if a user-defined filter is selected with :PDC:FILT:TYPE USER. To generate lists, cf. command [[:SOURce]:DM:FLISt:SEL, to fill up lists, cf. command [[:SOURce]:DM:FLISt:DATA.

Example: :SOUR:PDC:FILT:SEL 'test' \*RST value is NONE

**[[:SOURce]:PDC:FILTer:PARAmeter 0.1 to 0.7**

The command sets the filter parameter entry (Roll Off factor).

Example: :SOUR:PDC:FILT:PAR 0.51 \*RST value is 0.5

**[[:SOURce]:PDC:FILTer:MODE LACP | LEVM**

This command selects one of the "L"ow filter modes.

Example: :SOUR:PDC:FILT:MODE LEVM \*RST value is LACP

**[[:SOURce]:PDC:LDISortion[::STATe] ON | OFF**

The command sets the reduced level for the low-distortion mode.

Example: :SOUR:PDC:LDIS ON \*RST value is OFF

**[[:SOURce]:PDC:SEQuence AUTO | RETRigger | AAUTo | ARETrigger**

The command selects the trigger mode for the sequence.

AAUTo is ARMED AUTO

ARETrigger is ARMED RETRIG

Example: :SOUR:PDC:SEQ AAUT \*RST value is AUTO

**[[:SOURce]:PDC:TRIGger:SOURce EXTErnal | INTernAl**

The command selects the trigger source. With INT selected, triggering is via IEC/IEEE bus or the Execute command in manual control.

Example: :SOUR:PDC:TRIG:SOUR EXT \*RST value is INT

**[[:SOURce]:PDC:TRIGger:INHibit 0 to 67.1E6**

The command sets the retrigger inhibit duration (in number of symbols).

Example: :SOUR:PDC:TRIG:INH 1000

\*RST value is 0

**[[:SOURce]:PDC:TRIGger:DELay 0 to 65535**

The command sets the trigger delay (in number of symbols).

Example: :SOUR:PDC:TRIG:DEL 200

\*RST value is 0

**[[:SOURce]:PDC:TRIGgerOUTPut[2]:DELay 0 to 839**

The command determines the delay of the signal at trigger output 2 in comparison with the start of the frames/slots in number of symbols.

Example: :SOUR:PDC:TRIG:OUTP2:DEL 16

\*RST value is 0

**[[:SOURce]:PDC:TRIGger:OUTPut[2]:PERiod 1 to 67.1E6**

The command sets the repeat rate (in number of frames) of the signal at trigger output 2.

Example: :SOUR:PDC:TRIG:OUTP2:PER 8

\*RST value is 1

**[[:SOURce]:PDC:CLOCK**

The commands for setting the data clock are under this node.

**[[:SOURce]:PDC:CLOCK:SOURce INTERNAL | EXTERNAL**

The command selects the source for the DM data clock.

INTERNAL The internal clock generator is used and output via the clock outputs of the serial and parallel interface.

EXTERNAL The clock is externally fed in via the serial interface and output via the parallel interface.

Example: :SOUR:PDC:CLOC:SOUR INT

\*RST value is INT

**[[:SOURce]:PDC:CLOCK:MODE BIT | SYMBOL**

The command sets the clock mode for :PDC:CLOCK:SOURce EXTERNAL.

BIT The external clock has to be a bit clock.

SYMBOL The external clock has to be a symbol clock.

The bit and symbol clock only differ for modulations with more than two states, i.e. modulations for which more than one bit is required to code each state.

Example: :SOUR:PDC:CLOC:MODE BIT

\*RST value is SYMB

**[[:SOURce]:PDC:CLOCK:DELay 0 to 1.0**

The command sets the delay of the symbol clock (as a fraction of the length of a symbol).

Example: :SOUR:PDC:CLOC:DEL 0.75

\*RST value is 0

**[:SOURce]:PDC:PRAMp**

The commands for the level control of the burst are under this node.

**[:SOURce]:PDC:PRAMp:PRESet**

This command sets the standard-stipulated values for the following commands of level control. It is an event and hence has no query and no \*RST value.

Example: `:SOUR:PDC:PRAM:PRES`

**[:SOURce]:PDC:PRAMp:TIME 0.25 to 16.0**

The command sets the cutoff steepness (in symbol clocks).

Example: `:SOUR:PDC:PRAM:TIME 2.5` \*RST value is 2

**[:SOURce]:PDC:PRAMp:DELay -1.0 to + 1.0**

The command defines the shift of the envelope characteristic to the modulated signal. A positive value causes a delay of the envelope.

Example: `:SOUR:PDC:PRAM:DEL 0.2` \*RST value is 0

**[:SOURce]:PDC:PRAMp:SHAPE LINear | COSine**

The command selects the linear or cosine shape of the ramp-up and ramp-down (power burst).

Example: `:SOUR:PDC:PRAM:SHAP COS` \*RST value is COS

**[:SOURce]:PDC:PRAMp:ROFFset -9 to +9**

The command determines the timing of the ('R'ising) edge of a power burst to the beginning of the block.

Example: `:SOUR:PDC:PRAM:ROFF -3` \*RST value is 0

**[:SOURce]:PDC:PRAMp:FOFFset -9 to +9**

The command determines the timing of the ('F'alling) edge of a power burst to the data block

Example: `:SOUR:PDC:PRAM:FOFF 4` \*RST value is 0

**[:SOURce]:PDC:SLOT:ATTenuation 0 to 70 dB**

The command determines the amount by which the power of the slots marked by `:PDC:SLOT:LEVel ATT` is reduced in comparison with the normal output power (Attribut to `:LEVel FULL`).

Example: `:SOUR:PDC:SLOT:ATT 20 dB` \*RST value is 0

**[:SOURce]:PDC:LINK UP | DOWN**

The command determines the burst type which differs depending on the transmit direction. The structure of the frames is different and thus has an effect on the selection of possible `:PDC:SLOT` commands. This command is stored as a part of the `:PDC:FLISt` configurations (see below).

UP From mobile part to fixed part

DOWN From fixed part to mobile part

Example: `:SOUR:PDC:LINK DOWN` \*RST value is DOWN

**[:SOURce]:PDC:RCONfiguration** AHALf | FULL1 | FULL2 | FULL3 | FULL12 | FULL13 | FULL23 | AFUL

This configuration setup determines how the FULL- and HALF-rate channels (slots) are distributed among the frames. This command is stored as a part of the :PDC:FLIS configurations (see below).

AHALf	All Half
FULL0	FULL (0 & 3)
FULL1	FULL (1 & 4)
FULL2	FULL (2 & 5)
FULL10	FULL (1 & 4), (0 & 3)
FULL20	FULL (2 & 5), (0 & 3)
FULL21	FULL (2 & 5), (1 & 4)
AFUL	All Full

Example: :SOUR:PDC:RCON FULL0

\*RST value is AFUL

**[:SOURce]:PDC:FLIS**

The commands for storing and reading complete frames including their bursts (slots) are under this node. Predefined and user-generated frames have to be distinguished.

**[:SOURce]:PDC:FLIS:PREDefined:CATalog?**

The command returns a list of all predefined frames.

Example: :SOUR:PDC:FLIS:PRED:CAT?

**[:SOURce]:PDC:FLIS:PREDefined:LOAD** 'name'

The command selects one of the predefined (fixed) frames (c.f. Chapter 2) . This command triggers an event and hence has no \*RST value.

Example: :SOUR:PDC:FLIS:PRED:LOAD 'dn\_tch'

**[:SOURce]:PDC:FLIS:CATalog?**

The command returns a list of all user-defined frames.

Example: :SOUR:PDC:FLIS:CAT?

**[:SOURce]:PDC:FLIS:LOAD** 'name'

The command loads a user-defined frame. This command triggers an event and hence has no \*RST value.

Example: :SOUR:PDC:FLIS:LOAD 'test'

**[:SOURce]:PDC:FLIS:STORE** 'name'

The command stores the current frame under a name. This command triggers an event and hence has no \*RST value and no query.

Example: :SOUR:PDC:FLIS:STOR 'test'

**[:SOURce]:PDC:FLIS:DELETE** 'name'

The command deletes the indicated frame. This command triggers an event and hence has no \*RST value and no query.

Example: :SOUR:PDC:FLIS:DEL 'test1'

**[:SOURce]:PDC:DLIS:CATalog?**

The command returns an enumeration of all data lists.

These data lists are selected by means of :PDC:SLOT:SACC:DLIS, ...:RCH:DLIS, ...:SI:DLIS, or ...:DATA:DLIS 'name' and used if :PDC:SLOT:SACC, ...:RCH, SI, or ...:DATA DLIS are set.

Example: :SOUR:PDC:DLIS:CAT?

**[:SOURce]:PDC:SLOT<i>**

The commands for setting the slot characteristics are under this node. Since a frame contains 8 slots, suffix 'i' is used to select the slot to be changed. i = 0 | [1] | 2 | 3 | 3 | 5 | 6 | 7

**[:SOURce]:PDC:SLOT<i>:TYPE TCH | SYNC | VOX | ADATa**

The command selects the type of burst (slot) defined in the standard.

ADATa is All Data

Example: :SOUR:PDC:SLOT2:TYPE TCH \*RST value is TCH

**[:SOURce]:PDC:SLOT<i>:LEVeI OFF | ATT | FULL**

The command determines the power stage of the slot.

OFF The slot is inactive  
For UPLINK, the source is always at full power. Therefore, in the case of an DOWNLINK TCH burst, only a series of 1's is sent instead of the data.

ATT The power is reduced by the amount defined by :PDC:SLOT:ATT  
For an DOWNLINK TCH burst this setting is not valid.

FULL Full power (predefined by level setting)

Example: :SOUR:PDC:SLOT2:LEV ATT \*RST value is FULL

**[:SOURce]:PDC:SLOT<i>:PRESet**

The command sets all the parameters of the slot to the values defined by the standard as a function of the type set above. This command triggers an event and hence has no \*RST value and no query.

Example: :SOUR:PDC:SLOT2:PRES

**[:SOURce]:PDC:SLOT<i>:SCRamble**

The commands for setting the scramble method are under this node.

**[:SOURce]:PDC:SLOT<i>:SCRamble:STATe ON | OFF**

The command switches scrambling for data fields DATA, SI and SACCH on or off.

Example: :SOUR:PDC:SLOT2:SCR:STAT ON \*RST value is OFF

**[:SOURce]:PDC:SLOT<i>:SCRamble:STARt #H1 to #H1FF (9 bits)**

The command sets the start value for the scramble sequence.

Example: :SOUR:PDC:SLOT2:SCR:STAR #H12 \*RST value is 1

**[[:SOURCE]:PDC:SLOT<i>:SFRame:STATe ON | OFF**

This command switches the superframe on or off. When switched on, RCD data will be inserted instead of SACCH data in some slots and SYNC2 will be used instead of SYNC in the first slot of the superframe.

Example: :SOUR:PDC:SLOT2:SFR:STAT ON \*RST value is OFF

**[[:SOURCE]:PDC:SLOT<i>:SFRame:RCHPosition 1 to 17**

The command determines the position of the second RCH.

Example: :SOUR:PDC:SLOT2:SFR:RCHP 10 \*RST value is 1

**[[:SOURCE]:PDC:SLOT<i>[:SOURCE]**

The commands for determining the source for the data contents are under this node. The source is either a PRBS generator (with different sequence length), the data input SER DATA or a data list.

Selection of data source for the data fields of the burst:

PN9 to 23 PRBS generator has been selected

DLIS Data from a programmable data list

SDATa Data from data input SER DATA

**[[:SOURCE]:PDC:SLOT<i>[:SOURCE]:DATA PN9 | PN11 | PN15 | PN16 | PN20 | PN21 | PN23 | DLIS | SDATa**

The command determines the data source for the data words.

Example: :SOUR:PDC:SLOT3:DATA PN15 \*RST value is PN9

**[[:SOURCE]:PDC:SLOT<i>[:SOURCE]:DATA:DLIS 'name'**

The command selects a data list. This list will not be used unless it is set as a data source by means of the :PDC:SLOT:DATA DLIS command. This command triggers an event and hence has no \*RST value.

Example: :SOUR:PDC:SLOT:DATA:DLIS 'test'

**[[:SOURCE]:PDC:SLOT<i>[:SOURCE]:SACChannel PN9 | PN11 | PN15 | PN16 | PN20 | PN21 | PN23 | DLIS | SDATa**

The command determines the data source for the slow associated control channel (for :SLOT:TYPE TCH... and VOX).

Example: :SOUR:PDC:SLOT3:SACC PN15 \*RST value is PN9

**[[:SOURCE]:PDC:SLOT<i>[:SOURCE]:SACChannel:DLIS 'name'**

The command selects a data list. This list will not be used unless it is set as a data source by means of the :SOUR:PDC:SOUR:SLOT:SACC DLIS command. This command triggers an event and hence has no \*RST value.

Example: :SOUR:PDC:SLOT:SACC:DLIS 'test'

**[[:SOURCE]:PDC:SLOT<i>[:SOURCE]:RCHannel PN9 | PN11 | PN15 | PN16 | PN20 | PN21 | PN23 | DLIS | SDATa**

The command determines the data source for the housekeeping channel (for :SLOT:FRAME:STATe ON).

Example: :SOUR:PDC:SLOT2:RCH DLIS \*RST value is PN9



**[[:SOURce]:PDC:SLOT<i>[:SOURce]:RCHannel:DLIS 'name'**

The command selects a data list. This list will not be used unless it is set as a data source by means of the :SOUR:PDC:SLOT:RCH DLIS command. This command triggers an event and hence has no \*RST value.

Example: :PDC:SLOT:RCH:DLIS 'test'

**[[:SOURce]:PDC:SLOT<i>[:SOURce]:SI PN9 | PN11 | PN15 | PN16 | PN20 | PN21 | PN23 | DLIS | SDATa**

The command determines the data source for the sync information field (for :SLOT:TYPE SYNC).

Example: :SOUR:PDC:SLOT2:SI DLIS \*RST value is PN9

**[[:SOURce]:PDC:SLOT<i>[:SOURce]:SI:DLIS 'name'**

The command selects a data list. This list will not be used unless it is set as a data source by means of the :SOUR:PDC:SLOT:SI DLIS command. This command triggers an event and hence has no \*RST value.

Example: :SOUR:PDC:SLOT:SI:DLIS 'test'

**[[:SOURce]:PDC:SLOT<i>:PREamble #H0 to #H... (2/6/48/102 bits)**

The command sets the value of the 'P' bits. The length and the \*RST value depend on the slot type and the link direction:

:SLOT:TYPE	:LINK	Length (bits)	*RST value.
TCH	UP	2	2
SYNC	UP	48	9999 9999 9999
VOX	UP	6	26
TCH	DOWN	2	2
SYNC	DOWN	102	26 6666 6666 6666 6666 6666 6666

Example: :SOUR:PDC:SLOT2:PRE #H1 For \*RST value see above

**[[:SOURce]:PDC:SLOT<i>:SYNC #H0 to #HFFFFFF/FFFFFFFF (20/32 bits)**

The command sets the value of the sync word. The length 32bit is only available for SLOT:TYPE SYNC.

Example: :SOUR:PDC:SLOT2:SYNC #H1A \*RST value depends on SLOT

**[[:SOURce]:PDC:SLOT<i>:SYNC2 #H0 to #HFF... (20/32 bits)**

The command sets the value for the sync word in the superframe (only available for :PDC:SFRA:STAT ON).

Example: :SOUR:PDC:SLOT2:SYNC2 #H1AB \*RST value is 0

**[[:SOURce]:PDC:SLOT<i>:CCODE #H0 to #HFF (8 bits)**

The command sets the value for the color code.

Example: :SOUR:PDC:SLOT2:CCOD #H1F \*RST value is 0

**[[:SOURce]:PDC:SLOT<i>:POSTamble #H0 to 3FF... (78 bits)**

The command sets the value for postamble (only valid for SLOT:TYP SYNC and LINK DOWN).

Example: :SOUR:PDC:SLOT2:POST #HF2 \*RST value is 2666 6666 6666 6666 6666

**[[:SOURce]:PDC:SLOT<i>:SF 0 | 1**

The command sets the state of the steal flag.

Example: :SOUR:PDC:SLOT2:SF 1 \*RST value is 0

## 3.5.14.18 SOURce:PHASe Subsystem

Command	Parameter	Default Unit	Remark
[:SOURce] :PHASe [:ADJust] :REFerence	-360 deg to +360 deg	rad	No query

**[:SOURce]:PHASe[:ADJust] -360 deg to +360 deg**

The command indicates the phase between output signal and reference oscillator signal. This setting is only accepted using SOURce:PHASe:REFerence (cf. below). An indication in RADian is possible.

Example:   : SOUR: PHAS: ADJ 2DEG  
          : SOUR: PHAS: ADJ 0.1RAD

\*RST value is 0.0 DEG

**[:SOURce]:PHASe:REFerence**

The command accepts the phase set using SOURce:PHASe:ADJust as a new reference phase. The command has no \*RST value.

Example:   : SOUR: PHAS: REF

3.5.14.19 SOURce:PHS Subsystem

**Note** #H0 to #HF are characters which are entered in alphanumeric Hex form manually. SCPI (and IEEE 488.2) also accept the entry of non-decimal characters in octal and binary such as #H|h <0 to 9, A|a to F|f>, #Q|q <0 to 7> and #B|b <0|1>. The characters are always output in Hex format after a query.

Command	Parameter	Default unit	Remark
[:SOURce]			
:PHS			
:STATe	ON   OFF		
:STANdard			
:SRATe	1kHz to 200 kHz	Hz	
:FILTer			
:TYPE	SCOSine   COSine   USER		
:SELEct	'name'		
:PARAmeter	0.1 to 0.7		
:MODE	LACP   LEVM		
:LDISortion			
[:STATe]	ON   OFF		
:SEQUence	AUTO   RETRigger   AAUTo   ARETrigger		
:TRIGger			
:SOURce	EXTernal   INTernal		
:INHibit	0 to 67.1E6		
:DELay	0 to 65535		
:OUTPut[2]			
:DELay	0 to 959		
:PERiod	1 to 67.1E6		
:CLOCK			
:SOURce	INTernal   EXTernal		
:MODE	BIT   SYMBol   SBIT		
:DELay	0 to 1.0		
:PRAMP			
:PRESet			No query
:TIME	0.25 to 16		
:DELay	1.0 to +1.0		
:SHAPE	LINear   COSine		
:ROFFset	-9 to +9		
:FOFFset	-9 to +9		
:SLOT			
:ATTenuation	0 to 70 dB	DB	
:FLISt			
:PREDefined			
:CATalog?	=> name {,name}...		query only
:LOAD	'name'		
:CATalog?	=> name {,name}...		query only
:LOAD	'name'		
:STORE	'name'		no query
:DELEte	'name'		no query

Command	Parameter	Default unit	Remark
<pre> [:SOURce]   :PHS     :DLISt       :CATalog?     :SLOT&lt;i&gt;       :TYPE       :LEVel       :PRESet       :SCRamble         :STATe         :CODE       :ENCRyption         :STATe         :KEY       :UWORD       :CSID       :PSID       :IDLe     [:SOURce]       :SACChannel         :DLISt       :TCHannel         :DLISt </pre>	<pre> =&gt; name {,name}.. TCHFull   TCHHalf   SYNC   VOX   ADATa OFF   ATT   FULL - ON   OFF #H0 to #H3FF (10 bit) ON   OFF #H0 to #HFFFF (16 bits) #H0 to #HFFFFFFFF (16 or 32 bits) #H0 to #H3FFFFFFFFF (42 bits) #H0 to #HFFFFFFFF (28 bits) #H0 to #H3FFFFFFFFF (34 bits) PN9   PN11   PN15   PN 16   PN20   PN21   PN23   DLISt   SDATa 'name' PN9   PN11   PN15   PN 16   PN20   PN21   PN23   DLISt   SDATa 'name' </pre>		<p>query only</p> <p>No query</p>

#### [:SOURce]:PHS:STATe ON | OFF

The command switches the modulation on according to PHS standard. All other standards that might be switched on or digital modulation are automatically switched OFF.

Example: `:SOUR:PHS:STAT ON`

\*RST value is OFF

#### [:SOURce]:PHS:STANdard

The commands sets all modulation parameters to the values of the PHS standard. I.e., all values that have been selected by the `:PHS:SLOT...` commands described in the following are not valid. This command triggers an event and hence has no \*RST value and no query.

Example: `:SOUR:PHS:STAN`

#### [:SOURce]:PHS:SRATe 1kHz to 200 kHz

The command sets the symbol rate.

Example: `:SOUR:PHS:SRAT 192.1 kHz`

\*RST value is 192 kHz

#### [:SOURce]:PHS:FILTer

The commands for selecting a filter are under this node.

#### [:SOURce]:PHS:FILTer:TYPE SCOSine | COSine | USER

The command selects the type of filter. A filter list should be selected with `:PHS:FILT:SEL 'name'` for the filter type USER.

Example: `:SOUR:PHS:FILT:TYPE COS`

\*RST value is SCOS

**[:SOURce]:PHS:FILTer:SElect 'name'**

The command selects a named filter list. The list is used only if a user-defined filter is selected with :PHS:FILT:TYPE USER. To generate lists, cf. command [:SOURce]:DM:FLIST:SEL, to fill up lists, cf. command [:SOURce]:DM:FLIST:DATA.

Example: :SOUR:PHS:FILT:SEL 'test' \*RST value is NONE

**[:SOURce]:PHS:FILTer:PARAMeter 0.1 to 0.7**

The command sets the filter parameter entry (Roll Off factor).

Example: :SOUR:PHS:FILT:PAR 0.5 \*RST value is 0.5

**[:SOURce]:PHS:FILTer:MODE LACP | LEVM**

This command selects one of the "L"ow filter modes.

Example: :SOUR:PHS:FILT:MODE LEVM \*RST value is LACP

**[:SOURce]:PHS:LDISTortion[:STATe] ON | OFF**

The command sets the reduced level for the low-distortion mode.

Example: :SOUR:PHS:LDIS ON \*RST value is OFF

**[:SOURce]:PHS:SEQUence AUTO | RETRigger | AAUTO | ARETrigger**

The command selects the trigger mode for the sequence.

AAUTO is ARMED AUTO

ARETrigger is ARMED RETRIG

Example: :SOUR:PHS:SEQ AAUT \*RST value is AUTO

**[:SOURce]:PHS:TRIGger:SOURce EXTernal | INTernal**

The command selects the trigger source. With INT selected, triggering is via IEC/IEEE bus or the Execute command in manual control.

Example: :SOUR:PHS:TRIG:SOUR EXT \*RST value is INT

**[:SOURce]:PHS:TRIGger:INHibit 0 to 67.1E6**

The command sets the retrigger inhibit duration (in number of symbols).

Example: :SOUR:PHS:TRIG:INH 1000 \*RST value is 0

**[:SOURce]:PHS:TRIGger:DELay 0 to 65535**

The command sets the trigger delay (in number of symbols).

Example: :SOUR:PHS:TRIG:DEL 200 \*RST value is 0

**[:SOURce]:PHS:TRIGgerOUTPut[1]:DELay 0 to 959**

The command determines the delay of the signal at trigger output 2 in comparison with the start of the frames/slots in number of symbols.

Example: :SOUR:PHS:TRIG:OUTP2:DEL 16 \*RST value is 0

**[[:SOURce]:PHS:TRIGger:OUTPut[2]:PERiod 1 to 67.1E6**

The command sets the repeat rate (in number of frames) of the signal at trigger output 2.

Example: `:SOUR:PHS:TRIG:OUTP:PER 8` \*RST value is 1

**[[:SOURce]:PHS:CLOCK**

The commands for setting the data clock are under this node.

**[[:SOURce]:PHS:CLOCK:SOURce INTernal | EXTernal**

The command selects the source for the DM data clock.

INTernal The internal clock generator is used and output via the clock outputs of the serial and parallel interface.

EXTernal The clock is externally fed in via the serial interface and output via the parallel interface.

Example: `:SOUR:PHS:CLOC:SOUR INT` \*RST value is INT

**[[:SOURce]:PHS:CLOCK:MODE BIT | SYMBol**

The command sets the clock mode for `:PHS:CLOCK:SOURce EXTernal`.

BIT The external clock has to be a bit clock.

SYMBol The external clock has to be a symbol clock.

The bit and symbol clock only differ for modulations with more than two states, i.e. modulations for which more than one bit is required to code each state.

Example: `:SOUR:PHS:CLOC:MODE BIT` \*RST value is SYMB

**[[:SOURce]:PHS:CLOCK:DELay 0 to 1.0**

The command sets the delay of the symbol clock (as a fraction of the length of a symbol).

Example: `:SOUR:PHS:CLOC:DEL 0.75` \*RST value is 0

**[[:SOURce]:PHS:PRAMP**

The commands for the level control of the burst are under this node.

**[[:SOURce]:PHS:PRAMP:PRESet**

This command sets the standard-stipulated values for the following commands of level control. It is an event and hence has no query and no \*RST value.

Example: `:SOUR:PHS:PRAM:PRES`

**[[:SOURce]:PHS:PRAMP:TIME 0.25 to 16.0**

The command sets the cutoff steepness (in symbol clocks).

Example: `:SOUR:PHS:PRAM:TIME 2.5` \*RST value is 0

**[[:SOURce]:PHS:PRAMP:DELay -1.0 to + 1.0**

The command defines the shift of the envelope characteristic to the modulated signal. A positive value causes a delay of the envelope.

Example: `:SOUR:PHS:PRAM:DEL 0.2` \*RST value is 0

**[[:SOURce]:PHS:PRAMP:SHAPE LINear | COSine**

The command selects the linear or cosine shape of the ramp-up and ramp-down (power burst).

Example: `:SOUR:PHS:PRAMP:SHAP COS` \*RST value is LIN

**[[:SOURce]:PHS:PRAMP:ROFFset -9 to +9**

The command determines the timing of the ('R'ising) edge of a power burst to the beginning of the slot.

Example: `:SOUR:PHS:PRAMP:ROFF -3` \*RST value is 0

**[[:SOURce]:PHS:PRAMP:FOFFset -9 to +9**

The command determines the timing of the ('F'alling) edge of a power burst to the data block

Example: `:SOUR:PHS:PRAMP:FOFF 4` \*RST value is 0

**[[:SOURce]:PHS:SLOT:ATTenuation 0 to 70 dB**

The command determines the amount by which the power of the slots marked by `:PHS:SLOT:LEVEL ATT` is reduced in comparison with the normal output power (Attribut to `:LEVEL FULL`).

Example: `:SOUR:PHS:SLOT:ATT 20 dB` \*RST value is 0

**[[:SOURce]:PHS:FLISt**

The commands for storing and reading complete frames including their bursts (slots) are under this node. Predefined and user-generated frames have to be distinguished.

**[[:SOURce]:PHS:FLISt:PREDefined:CATalog?**

The command returns a list of all predefined frames.

Example: `:SOUR:PHS:FLIS:PRED:CAT?`

**[[:SOURce]:PHS:FLISt:PREDefined:LOAD 'name'**

The command selects one of the predefined (fixed) frames (c.f. Chapter 2). This command triggers an event and hence has no \*RST value.

Example: `:SOUR:PHS:FLIS:PRED:LOAD 'test'` \*RST value is 0

**[[:SOURce]:PHS:FLISt:CATalog?**

The command returns a list of all user-defined frames.

Example: `:SOUR:PHS:FLIS:CAT?`

**[[:SOURce]:PHS:FLISt:LOAD 'name'**

The command loads a user-defined frame. This command triggers an event and hence has no \*RST value.

Example: `:SOUR:PHS:FLIS:LOAD 'test'`

**[[:SOURce]:PHS:FLISt:STORe 'name'**

The command stores the current frame under a name. This command triggers an event and hence has no \*RST value and no query.

Example: `:SOUR:PHS:FLIS:STOR 'test'`

**[[:SOURCE]:PHS:FLIS:DELeT 'name']**

The command deletes the indicated frame. This command triggers an event and hence has no \*RST value and no query.

Example: :SOUR:PHS:FLIS:DEL 'test1'

**[[:SOURCE]:PHS:DLIS:CATalog?]**

The command returns an enumeration of all data lists.

These data lists are selected by means of :PHS:SLOT:SACC:DLIS 'name' and . . . :TCH:DLIS 'name' and used if :PHS:SLOT:SACC DLIS and . . . :TCH DLIS are set.

Example: :SOUR:PHS:DLIS:CAT?

**[[:SOURCE]:PHS:SLOT<i>]**

The commands for setting the slot characteristics are under this node. Since a frame contains 8 slots, suffix 'i' is used to select the slot to be changed. i = [1] | 2 | 3 | 3 | 5 | 6 | 7 | 8

**[[:SOURCE]:PHS:SLOT<i>:TYPE TCHFull | TCHHalf | SYNC | VOX | ADATa]**

The command selects the type of burst (slot) defined in the standard.

ADATa All Data

Example: :SOUR:PHS:SLOT2:TYPE TCHH

Slot1: \*RST value is SYNC  
Slot2 to 8: \*RST value is TCHF

**[[:SOURCE]:PHS:SLOT<i>:LEVeL OFF | ATT | FULL]**

The command determines the power stage of the slot.

OFF The slot is inactive

For UPLINK, the source is always at full power. Therefore, in the case of an DOWNLINK TCH burst, only a series of 1's is sent instead of the data.

ATT The power is reduced by the amount defined by :PHS:SLOT:ATT  
For an DOWNLINK TCH burst this setting is not valid.

FULL Full power (predefined by level setting)

Example: :SOUR:PHS:SLOT2:LEV ATT

slot1: \*RST value is FULL  
slot2 to slot8: \*RST value is OFF

**[[:SOURCE]:PHS:SLOT<i>:PRESet]**

The command sets all the parameters of the slot to the values defined by the standard as a function of the type set above. This command triggers an event and hence has no \*RST value and no query.

Example: :SOUR:PHS:SLOT2:PRES

**[[:SOURCE]:PHS:SLOT<i>:SCRamble]**

The commands for setting the scramble method are under this node.

**[[:SOURCE]:PHS:SLOT<i>:SCRamble:STATe ON | OFF]**

The command switches scrambling on or off.

Example: :SOUR:PHS:SLOT2:SCR:STAT ON

\*RST value is OFF



**[[:SOURce]:PHS:SLOT<i>:SCRamble:CODE #H0 to #H3FF**

The command sets the 10-bit scramble value.

Example: :SOUR:PHS:SLOT2:SCR:CODE #H123 \*RST value is 0

**[[:SOURce]:PHS:SLOT<i>:ENCRyption**

The commands to determine encryption are under this node.

**[[:SOURce]:PHS:SLOT<i>:ENCRyption:STATe ON | OFF**

This command defines whether or not the data are to be encrypted according to the predefined method.

Example: :SOUR:PHS:SLOT2:ENCR:STAT ON \*RST value is OFF

**[[:SOURce]:PHS:SLOT<i>:ENCRyption:KEY #H0 to #HFFFF**

The command enters the 16-bit code for encryption or decryption .

Example: :SOUR:PHS:SLOT2:KEY #H1234 \*RST value is 0

**[[:SOURce]:PHS:SLOT<i>:UWORd #H0 to #HFFFFFFF**

The command enters the 16/32-bit synchronization value (unique word). The number of bits depends on the type of slot. \*RST value depends on SLOT:TYPE

Example: :SOUR:PHS:SLOT2:UWOR #HA1B2C3D4

**[[:SOURce]:PHS:SLOT<i>:CSID #H0 to #H3FFFFFFFF**

The command enters the 42-bit cell station ID code .

Example: :SOUR:PHS:SLOT2:CSID #H12345FEDCBA

**[[:SOURce]:PHS:SLOT<i>:PSID #H0 to #HFFFFFFF**

The command enters the 28-bit personal station ID code.

Example: :SOUR:PHS:SLOT2:PSID #H1234567

**[[:SOURce]:PHS:SLOT<i>:IDLe #H0 to #HFFFFFFF**

The command enters the 24-bit Idle bit.

Example: :SOUR:PHS:SLOT2:PSID #H1234567

**[[:SOURce]:PHS:SLOT<i>[:SOURce]**

The commands for determining the source for the data contents are under this node. The source is either a PRBS generator (with different sequence length) or a data list.

Selection of data source for the data fields of the burst:

PN9 to 23 PRBS generator has been selected

DLISt Data of a programmable data list

SDATa Data from data input SER DATA

**[[:SOURce]:PHS:SLOT<i>[:SOURce]:SACChannel PN9 | PN11 | PN15 | PN16 | PN20 | PN21 | PN23 | DLISt | SDATa**

The command determines the data source for the slow associated control channel (for :SLOT:TYPE TCH... and VOX).

Example: :SOUR:PHS:SLOT3:SACC PN15 \*RST value is PN9

**[[:SOURCE]:PHS:SLOT<i>[:SOURCE]:SACChannel:DLIS 'name'**

The command selects a data list. This list will not be used unless it is set as a data source by means of the :PHS:SLOT:SACC DLIS command. This command triggers an event and hence has no \*RST value.

Example: :PHS:SLOT:SACC:DLIS 'test'

**[[:SOURCE]:PHS:SLOT<i>[:SOURCE]:TChannel PN9 | PN11 | PN15 | PN16 | PN20 | PN21 | PN23 | DLIS | SDATa**

The command determines the data source for the traffic channel (for :SLOT:TYPE TCH... and VOX).

Example: :SOUR:PHS:SLOT2:TCH PN9 \*RST value is PN9

**[[:SOURCE]:PHS:SLOT<i>[:SOURCE]:TChannel:DLIS 'name'**

The command selects a data list. This list will not be used unless it is set as a data source by means of the :PHS:SLOT:TCH DLIS command. This command triggers an event and hence has no \*RST value.

Example: :PHS:SLOT:TCH:DLIS 'test'

**3.5.14.20 SOURce:PM Subsystem**

This subsystem contains the commands to check the phase modulation and to set the parameters of the modulation signal. The SMIQ can be equipped with two independent phase modulators (option SM-B5). They are differentiated by a suffix after PM.

SOURce:PM1  
SOURce:PM2

Command	Parameter	Default Unit	Remark
<b>[:SOURce]</b> <b>:PM1 2</b>			Option SM-B5
<b>[:DEVIation]</b>	-360 deg to +360 deg	rad	
<b>:EXTernal1 2</b> <b>:COUPling</b>	AC   DC		
<b>:INTernal</b> <b>:FREQUency</b>	0.1Hz to 1 MHz	Hz	
<b>:SOURce</b>	INT   EXT1   EXT2		
<b>:STATe</b>	ON   OFF		

**[:SOURce]:PM1|2[:DEVIation]** -360 to +360 deg

The command sets the modulation depth in Radian. DEGREE are accepted.

\*RST value is 1 rad

Example: SOUR:PM:DEV 20DEGR

**[:SOURce]:PM1|2:EXTernal1|2**

The commands to check the external input of the PM modulators are under this node. The settings under EXTernal for modulations AM, FM and PM are independent of each other. The settings are always related to the socket determined by the suffix after EXTernal. The suffix after PM is ignored then. With the following commands, e.g., the settings are both related to socket EXT2:

:SOUR:PM1:EXT2:COUP AC  
:SOUR:PM2:EXT2:COUP AC

A command without suffix is interpreted like a command with suffix 1.

**[:SOURce]:PM1|2:EXTernal1|2:COUPling** AC | DC

The command selects the type of coupling for the external PM input.

AC The d.c. voltage content is separated from the modulation signal.

DC The modulation signal is not changed.

\*RST value is AC

Example: :SOUR:PM:COUP DC

**[:SOURce]:PM1|2:INTernal**

The settings for the internal PM generators are effected under this node. For PM1, this is always LF generator 1, for PM2, always LF generator 2. Here the same hardware is set for FM1, PM1, AM::INT1 as well as SOURce0, for FM2, PM2 and AM:INT2 and SOURce2 as well. This means that, e.g., the following commands are coupled with each other and have the same effect:

SOUR:AM:INT2:FREQ  
SOUR:FM2:INT:FREQ  
SOUR:PM2:INT:FREQ  
SOUR2:FREQ:CW

**[[:SOURce]:PM1|2:INTernal:FREQuency** 0.1 Hz to 1 MHz

The command sets the modulation frequency.

\*RST value is 1 kHz

Example: :SOUR:PM:INT:FREQ 10kHz

**[[:SOURce]:PM1|2:SOURce** INTernal | EXTernal1 | EXTernal2

The command selects the modulation source. A command without suffix is interpreted like a command with suffix 1. For PM1 the LF generator is INTernal. For PM2, only the external sources can be used (not the internal LF generator).

The external and the internal modulation source can be indicated at the same time (see example)

\*RST value for PM1: INT

Example: :SOUR:PM:SOUR INT; PM2:SOUR EXT2

for PM2:EXT2

**[[:SOURce]:PM1|2:STATe** ON | OFF

The command switches the phase modulation selected by the numeric suffix with PM on or off.

Example: :SOUR:PM1:STAT OFF

\*RST value is OFF

3.5.14.21 SOURce:POWer Subsystem

This subsystem contains the commands to set the output level, the level control and the level correction of the RF signal. Other units can be used instead of dBm:

- by indication directly after the numeric value (Example :POW 0.5V),
- by altering the DEFault unit in the UNIT system (see Command :UNIT:POWER)

Command	Parameter	Default Unit	Remark
[:SOURce] :POWer :ALC [:STATe] :SEARch :TABLe [:MEASure]? [:LEVel] [:IMMediate] [:AMPLitude] :OFFSet :RCL :LIMit [:AMPLitude] :MANual :MODE :PEP? :STARt :STOP :STEP [:INCRement]	ON   OFF   AUTO ON   OFF   ONCE  -144 to +16 dBm -100 to +100 dB INCLude   EXCLude  -144 to +16 dBm -144 to +16 dBm FIXed   SWEEp   LIST  -144 to +16 dBm -144 to +16 dBm 0.1 to 10 dB	    dBm dB   dBm dBm  dBm dBm  dB	   query only

[:SOURce]:POWer:ALC

The commands checking the automatic level control are under this node.

[:SOURce]:POWer:ALC:TABLe[:MEASure]?

The command starts a calibration measurement. It fills the level table for the POW:ALC:SEARCh OFF mode.

Example: :SOUR:POW:ALC:TABL:MEAS? Answer: 0

[:SOURce]:POWer:ALC[:STATe] ON | OFF | AUTO

The command switches level control on or off.

ON Level control is permanently switched on.

OFF Level control is handled depending on POW:ALC:SEAR described below.

AUTO Depending on the operating mode, level control is automatically switched on or off.

Example: :SOUR:POW :ALC:STAT ON \*RST value is ON

**[[:SOURce]:POWer:ALC:SEARch ON | OFF | ONCE**

This command is only valid with level control switched off.

ON Level control is switched on briefly after a level or frequency change (SAMPLE & HOLD).

OFF Level control is never switched on (TABLE mode).

ONCE Level control is briefly switched on for calibration.

Example: :SOUR:POW :ALC:SEAR ONCE \*RST value: ON

**[[:SOURce]:POWer[:LEVel][:IMMediate][:AMPLitude] -144 to +16 dBm**

The command sets the RF output level in operating mode CW. UP and DOWN can be indicated in addition to numeric values. Then the level is increased or reduced by the value indicated under :SOURce:POWer:STEP.

In this command, the OFFSet value is considered as with input value AMPLITUDE in the LEVEL-LEVEL menu. Thus the specified range indicated is only valid for :POWer:OFFSet = 0. The specified range with other OFFSet values can be calculated according to the following formula (cf. Chapter 2, Section "Level Offset" as well):

$$-144\text{dBm} + \text{OFFSet} \text{ to } +16\text{dBm} + \text{OFFSet}$$

The keywords of this command are optional to a large extent, thus the long as well as the short form of the command is shown in the example. \*RST value is -30 dBm

Example: :SOUR:POW:LEV:IMM:AMPL 15 or  
:POW 15

**[[:SOURce]:POWer[:LEVel][:IMMediate]:OFFSet -100 to +100 dB**

The command enters the constant level offset of a series-connected attenuator/amplifier (cf. Chapter 2, Section "Level Offset"). If a level offset is entered, the level entered using :POWer:AMPLitude does no longer conform to the RF output level. The following connection is true:

$$:\text{POWer} = \text{RF output level} + \text{POWer:OFFSet}.$$

Entering a level offset does not change the RF output level but only the query value of :POWer:AMPLitude.

Only dB is permissible as a unit here, linear units (V, W etc.) are not permitted.

**Caution:** The level offset is also valid in the case of level sweeps!

Example: :SOUR:POW:LEV:IMM:OFFS 0 or \*RST value is 0  
:POW:OFFS 0

**[[:SOURce]:POWer[:LEVel][:IMMediate][:AMPLitude]:RCL INCLude | EXCLude**

The command determines the effect of the recall function on the RF level.\*RST value has no effect to this setting.

INCLude The saved RF level is loaded when instrument settings are loaded with the [RECALL] key or with a memory sequence.

EXCLude The RF level is not loaded when instrument settings are loaded, the current settings are maintained.

Example: :SOUR:POW:RCL INCL

**[[:SOURce]:POWer:LIMit[:AMPLitude] -144 to + 16 dBm**

The command limits the maximum Rf output level in operating mode CW and SWEEP. It does not influence the display LEVEL and the answer to query POW?.

Example: :SOUR:POW:LIM:AMPL 15 \*RST value is +16 dBm

**[:SOURce]:POWer:MANual -144 to +16 dBm**

The command sets the level if SOURce:POWer:MODE is set to SWEep and SOURce:SWEep:MODE to MANual. Only level values between START and STOP are permissible. (As to specified range, cf. :POWer). \*RST value is -30 dBm

Example: :SOUR:POW:MAN 1dBm

**[:SOURce]:POWer:MODE FIXed | SWEep | LIST**

The command specifies the operating mode and thus also by means of which commands the level setting is checked.

**FIXed** The output level is specified by means of commands under :SOURce:POWer:LEVel.

**SWEep** The instrument operates in the SWEep mode. The level is specified by means of :SOURce:POWer:STARt; STOP; CENTer; SPAN and MANual.

**LIST** The instrument processes a list of frequency and level settings. The settings are effected in the SOURce:LIST subsystem.

Setting :SOURce:POWer:MODE LIST automatically sets command :SOURce:FREQuency:MODE to LIST as well.

Example: :SOUR:POW:MODE FIX \*RST value is FIXed

**[:SOURce]:POWer:PEP?**

This command returns the peak envelope power in dBm (Digital Modulation and Digital Standards).

Example: :POW:PEP?

**[:SOURce]:POWer:STARt -144 to +16 dBm**

The command sets the starting value for a level sweep. STARt may be larger than STOP, then the sweep runs from the high to the low level (As to specified range, cf. :POWer:AMPLitude).

Example: :SOUR:POW:STAR -20 \*RST value is -30dBm

**[:SOURce]:POWer:STOP -144 to +16 dBm**

The command sets the final value for a level sweep. STOP may be smaller than STARt. (As to specified range, cf. :POWer:AMPLitude). \*RST value is -10dBm

Example: :SOUR:POW:STOP 3

**[:SOURce]:POWer:STEP[:INCRement] 0.1 to 10 dB**

The command sets the step width with the level setting if UP and DOWN are used as level values. The command is coupled with KNOB STEP in the manual control, i.e., it also specifies the step width of the shaft encoder.

Only dB is permissible as a unit here, the linear units (V, W etc.) are not permitted.

Example: :SOUR:POW:STEP:INCR 2 \*RST value is 1dB

### 3.5.14.22 SOURce:PULM Subsystem

This subsystem contains the commands to check the external pulse modulation

Command	Parameter	Default Unit	Remark
[:SOURce] :PULM :POLarity :STATe	NORMal   INVerted ON   OFF		

#### [:SOURce]:PULM:POLarity NORMal | INVerted

The command specifies the polarity between modulating and modulated signal.

NORMal The RF signal is suppressed during the interpulse period.

INVerted The RF signal is suppressed during the pulse.

Example: :SOUR:PULM:POL INV

\*RST value is NORMal

#### [:SOURce]:PULM:STATe ON | OFF

The command switches on or off the pulse modulation.

Example: :SOUR:PULM:STAT ON

\*RST value is OFF



**3.5.14.23 SOURce:ROSCillator Subsystem**

This subsystem contains the commands to set the external and internal reference oscillator.

Command	Parameter	Default Unit	Remark
<b>[[:SOURce]                      :ROSCillator                      :EXTernal                      :FREQUENCY                      [:INTernal]                      :ADJust                      [:STATe]                      :VALue                      :SOURce</b>	1 to 16 MHz     ON   OFF 0 to 4095 INTernal   EXTernal	Hz	

**[[:SOURce]:ROSCillator:EXTernal**

The commands to set the external reference oscillator are under this node.

**[[:SOURce]:ROSCillator:EXTernal:FREQUENCY 1 to 16 MHz**

The command informs the instrument about at which frequency the external reference oscillator oscillates.

Example: `:SOUR:ROSC:FREQ 5MHz` \*RST value is 10 MHz

**[[:SOURce]:ROSCillator[:INTernal]**

The commands to set the internal reference oscillator are under this node.

**[[:SOURce]:ROSCillator[:INTernal]:ADJust**

The commands for frequency correction (fine adjustment of the frequency) are under this node.

**[[:SOURce]:ROSCillator[:INTernal]:ADJust[:STATe] ON | OFF**

The command switches the fine adjustment of the frequency on or off.

Example: `:SOUR:ROSC:INT:ADJ:STAT ON` \*RST value is OFF

**[[:SOURce]:ROSCillator[:INTernal]:ADJust:VALue 0 to 4095**

The command indicates the frequency correction value (tuning value). For a detailed definition, cf. Chapter 2, Section "Reference Frequency Internal/External".

Example: `:SOUR:ROSC:INT:ADJ:VAL 2048` \*RST value is 2048

**[[:SOURce]:ROSCillator:SOURce INTernal | EXTernal**

The command selects the reference source.

Internal The internal oscillator is used.

External The reference signal is fed externally.

Example: `:SOUR:ROSC:SOUR EXT` \*RST value is INT

### 3.5.14.24 SOURce:SWEep Subsystem

This subsystem contains the commands to check the RF sweep, i.e., sweeps of the RF generators. Sweeps are triggered on principle. The frequency sweep is activated by command `SOURce:FREQuency:MODE SWEep`, the level sweep by command `SOURce:POWEr:MODE SWEep`.

Command	Parameter	Default Unit	Remark
<code>[[:SOURce] :SWEep :BTIME [:FREQuency] :DWELI :MODE :POINTs :SPACing :STEP [:LINear] :LOGarithmic :POWEr :DWELI :MODE :POINTs :STEP [:LOGarithmic]</code>	<code>NORMal   LONG  10 ms to 5 s AUTO   MANual   STEP Number LINear   LOGarithmic  0 to 1 GHz 0.01 to 50 PCT  10 ms to 5 s AUTO   MANual   STEP Number 0 to 10 dB</code>	<code>   s     Hz PCT  s    dB</code>	

#### `[[:SOURce]:SWEep:BTIME NORMal | LONG`

The command sets the blank time (Blank TIME) of the sweep. The setting is valid for all sweeps, i.e., also for LF sweeps.

`NORMal` Blank time as short as possible.

`LONG` Blank time long enough to permit an XY recorder to return to 0.

Example: `:SOUR:SWE:BTIM LONG` \*RST value is NORM

#### `[[:SOURce]:SWEep[:FREQuency]`

The commands to set the frequency sweeps are under this node. Keyword `[ :FREQuency ]` can be omitted (cf. examples). The commands are SCPI compatible then unless stated otherwise.

#### `[[:SOURce]:SWEep[:FREQuency]:DWELI 10 ms to 5 s`

The command sets the dwell time per frequency step.

Example: `:SOUR:SWE:DWEL 12ms` \*RST value is 15 ms

#### `[[:SOURce]:SWEep[:FREQuency]:MODE AUTO | MANual | STEP`

The command specifies the run of the sweep.

`AUTO` Each trigger triggers exactly one entire sweep cycle.

`MANual` Each frequency step of the sweep is triggered by means of manual control or a `SOURce:FREQuency:MANual` command, the trigger system is not active. The frequency increases or decreases (depending on the direction of the shaft encoder) by the value indicated under `[ :SOURce ] :FREQuency :STEP :INCRement`.

`STEP` Each trigger triggers only one sweep step (single-step mode). The frequency increases by the value indicated under `[ :SOURce ] :SWEep :STEP :LOGarithmic`.

Example: `:SOUR:SWE:MODE AUTO` \*RST value is AUTO

**[:SOURce]:SWEep[:FREQUENCY]:POINTs** Number

The command determines the number of steps in a sweep.

Instead of this command, commands `SOURce:SWEep:FREQUENCY:STEP:LINEar` and `SOURce:SWEep:FREQUENCY:STEP:LOGarithmic` should be used, as `SOURce:SWEep:FREQUENCY:POINTs` has been adapted to the instrument characteristics in comparison to the SCPI command.

The value of POINTs depends on SPAN and STEP according to the following formulas..

The following is true for linear sweeps :  $POINTs = SPAN / STEP:LIN + 1$

The following is true for logarithmic sweeps and START < STOP:

$POINTs = ((\log STOP - \log START) / \log (1 + STEP:LOG))$

Two independent POINTs values are used for SPACing LOG and SPACing LIN. I.e., before POINTs is changed, SPACing must be set correctly. A change of POINTs results in an adaptation of STEP, but not of START, STOP and SPAN.

Example: `:SOUR:SWE:POIN 100`

**[:SOURce]:SWEep[:FREQUENCY]:SPACing** LINEar | LOGarithmic

The command selects whether the steps have linear or logarithmic spacings.

Example: `:SOUR:SWE:SPAC LIN` \*RST value is LIN

**[:SOURce]:SWEep[:FREQUENCY]:STEP**

The commands to set the step width for linear and logarithmic sweeps. The settings for STEP:LIN and STEP:LOG are independent.

**[:SOURce]:SWEep[:FREQUENCY]:STEP[:LINEar]** 0 to 1 GHz

The command sets the step width with the linear sweep. If STEP[:LINEar] is changed, the value of POINTs valid for SPACing:LINEar also changes according to the formula stated under POINTs. A change of SPAN does not result in a change of STEP[:LINEar]. Keyword [:LINEar] can be omitted, then the command conforms to SCPI regulations (see example).

Example: `:SOUR:SWE:STEP 1MHZ` \*RST value is 1 MHz

**[:SOURce]:SWEep[:FREQUENCY]:STEP:LOGarithmic** 0.01 to 50 PCT

The command indicates the step width factor for logarithmic sweeps. The next frequency value of a sweep is calculated according to

new frequency = prior frequency + STEP:LOG x prior frequency (if START < STOP)

STEP:LOG indicates the fraction of the prior frequency by which this is increased for the next sweep step. Usually STEP:LOG is indicated in percent, with the suffix PCT having to be used explicitly. If STEP:LOG is changed, the value of POINTs valid for SPAC:LOG also changes according to the formula stated under POINTs. A change of START or STOP does not result in a change of STEP:LOG.

Example: `:SOUR:SWE:STEP:LOG 10PCT` \*RST value is 1 PCT

**[:SOURce]:SWEep:POWER:DWELI** 10 ms to 5 s

The command sets the dwell time per level step.

Example: `:SOUR:SWE:POW:DWEL 12ms` \*RST value is 15 ms

**[[:SOURce]:SWEep:POWER:MODE AUTO | MANual | STEP**

The command specifies the run of the sweep.

**AUTO** Each trigger triggers exactly one entire sweep cycle.

**MANual** Each level step of the sweep is triggered by means of manual control or a `SOURce:POWER:MANual` command, the trigger system is not active. The level increases or decreases (depending on the direction of the shaft encoder) by the value stated under `:SOURce:POWER:STEP:INCRement`.

**STEP** Each trigger triggers only one sweep step (single-step mode). The level increases by the value indicated under `:SOURce:POWER:STEP:INCRement`.

Example: `:SOUR:SWE:POW:MODE AUTO` \*RST value is AUTO

**[[:SOURce]:SWEep:POWER:POINTS Number**

The command determines the number of steps in a sweep. Instead of this command, command `SOURce:SWEep:POWER:STEP:LOGarithmic` should be used, as POINTs has been adapted to the instrument characteristics in comparison to the SCPI command.

The value of :POINTS depends on .SPAN and :STEP according to the following formulas:

$$\text{POINTS} = ((\log \text{STOP} - \log \text{START}) / \log \text{STEP:LOG}) + 1$$

A change of POINTs results in an adaptation of STEP but not of START and STOP.

Example: `:SOUR:SWE:POW:POIN 100`

**[[:SOURce]:SWEep:POWER:STEP**

The commands to set the step width for a sweep are under this node.

**[[:SOURce]:SWEep:POWER:STEP[:LOGarithmic] 0 to 10 dB**

The command indicates the step width factor for logarithmic sweeps. The next level value of a sweep is calculated according to

$$\text{new level} = \text{prior level} + \text{STEP:LOG} \times \text{prior level}$$

STEP:LOG indicates the fraction of the prior level by which this is increased for the next sweep step. Usually STEP:LOG is indicated in dB, with suffix dB having to be used explicitly. If STEP:LOG is changed, the value of POINTs also changes according to the formula indicated under POINTs. A change of START or STOP does not result in a change of STEP:LOG. Keyword :LOG can be omitted, then the command conforms to SCPI regulation (see example).

Example: `:SOUR:SWE:STEP:LOG 10dB` \*RST value is 1dB

3.5.14.25 SOURce:WCDMA Subsystem (NTT DoCoMo/ARIB 0.0)

**Note:** #H0 to #HF are numerals which are entered in alphanumerical hex syntax in manual operation. SCPI (and IEEE 488.2) allow the octal and binary entry for non-decimal numbers in the following form  
 #H|h <0 to 9, A|a to F|f>,  
 #Q|q <0 to 7> and  
 #B|b <0|1>.  
 However, the hex format is always used for the output generated by a query.

Command	Parameter	Default Unit	Remark
[:SOURce]			
:WCDMA			
:STATe	ON   OFF		
:MODE	CHAN4   CHAN8   CHAN15		
:PRESet	(without)		
:CRATe	R4M   R8M		
:LINK	DOWN   UP   UPMulti		
:FORMat	QPSK   OQPSK		
:CRATe			
:VARIation	100cps to 7.5Mcps		
:FILTer			
:TYPE	SCOSine   COSine   WCDMA   USER		
:SElect	'name'		
:PARAmeter	0.1 to 0.7		
:MODE	LACP   LEVM		
:LDISortion			
[:STATe]	ON   OFF		
:SEquence	AUTO   RETRigger   AAUTO   ARETrigger		
:TRIGger			
:SOURce	EXTernal   INTernal		
:INHibit	0 to 67108863		
:DELay	0 to 65535		
:OUTPut[1]  2	SLOT   RFRame   CSPeriod		
:DELay	0 to 40959 (81919)		
:POLarity	POSitive   NEGative		
:CLOCK			
:SOURce	INTernal   EXTernal		
:POWER?		dBm	query only
:ADJust	(without)		
:MULTicode			
:STATe	ON   OFF		
:MASTer	0 to 3		
:CHANnels	#H0 to #HFF		
:SLENgth	1 to 256		

Command	Parameter	Default Unit	Remark
[:SOURCE] :WCDMa :CHANnel<0..14> [:!] :Q :TYPE :SRATe :SCODE :LCODE :OFFSet :SCODE :LMS [:!] :Q :POWer :DATA :DLISt :OFFSet :TPC :DLISt :STATe	⇒ name {,name}...  PERCh   CCPCh   DPCH   DPDCh   DPCCh   ALLD D16   D32   D64   D128   D256   D512   D1024 0 to 511 #H0 to #H3FFFF (#H1FFFFFFFFFFFF) 0 to 40959 (81919) #H0 to #HFF  -30 to 0 PN9   PN11   PN15   PN16   DLISt 'name' 0 to 10239 ZERO   ONE   ALTErnate   DLISt 'name' ON   OFF	dB	

**Note:** The calculation of the W-CDMA sequences is rather time-consuming and should be re-started for any new setting. The WCDMA modulation is therefore switched off for each command (autom. WCDM:STAT OFF performed). The user can then perform several settings without any delay and has to switch on again the WCDMA modulation (with WCDM:STAT ON). The calculations are performed and the previous settings are effective after the command is given.

#### [:SOURCE]:WCDMa:STATe ON | OFF

The command switches on the modulation in line with the W-CDMA procedure (ARIB standard). Option SMIQB43 is required for this purpose. All other standards that are switched on or the digital modulation are automatically switched to off state.

Caution: The command with ON should be used after any :WCDM command or after a series of WCDM commands in order to activate the previous settings.

Example: :SOUR:WCDM:STAT ON

\*RST value is OFF

#### [:SOURCE]:WCDMa:MODE CHAN4 | CHAN8 | CHAN15

The command selects the number of code channels. The limitations for setting the power of different channels thus become effective.

Example: :SOUR:WCDM:MODE CHAN4

\*RST value is CHAN8

#### [:SOURCE]:WCDMa:PRESet

The command sets all the following settings to a defined initial state (as after \*RST). This ensures that a signal is actually generated and that it is in line with the standard. This command triggers an event and hence has no \*RST value and no query.

Example: :SOUR:WCDM:PRES

**[:SOURce]:WCDMa:CRATe R4M | R8M**

The command sets the chip rate (4.096M or 8.192Mcps). R8M is possible only with a certain hardware configuration.

Example: `:SOUR:WCDM:CRAT R4M` \*RST value is R4M

**[:SOURce]:WCDMa:LINK DOWN | UP | UPMulti**

The command selects the mode of the transmitted signal.

Example: `:SOUR:WCDM:LINK UPM` \*RST value is DOWN

**[:SOURce]:WCDMa:FORMat QPSK | OQPSK**

The command selects the type of modulation (OQPSK: Offset QPSK).

Example: `:SOUR:WCDM:FORM OQPSK` \*RST value is QPSK

**[:SOURce]:WCDMa:CRATe:VARiation 100cps to 7.5Mcps**

The command selects the modification of the chip-clock frequency set with `:WCDM:CRAT R4M | R8M`.

Example: `:SOUR:WCDM:CRAT:VAR 1.2M` \*RST value is 4.096M

**[:SOURce]:WCDMa:FILTer**

The commands for selecting the baseband filter are under this node.

**[:SOURce]:WCDMa:FILTer:TYPE SCOSine | COSine | WCDMa | USER**

The command selects the type of filter. A filter list should be selected with `:WCDM:FILT:SEL 'name'` for the filter type USER.

SCOSine Square root cosine (root Nyquist) filter

COSine Cosine (Nyquist) filter

WCDMa Root Nyquist filter with fixed roll-off factor 0.22

USER User defined filter

Example: `:SOUR:WCDM:FILT:TYP COS` \*RST value is WCDM

**[:SOURce]:WCDMa:FILTer:SELEct 'name'**

The command selects a named filter list. The list is used only if a user-defined filter is selected with `:WCDM:FILT:TYPE USER`. To generate lists, cf. command `[:SOURce]:DM:FLISt:SEL`, to fill up lists, cf. command `[:SOURce]:DM:FLISt:DATA`.

Example: `:SOUR:WCDM:FILT:SEL 'test'` \*RST value is NONE

**[:SOURce]:WCDMa:FILTer:PARAmeter 0.1... 0.7**

The command sets the roll-off factor for the COS filters.

Example: `:SOUR:WCDM:FILT:PAR 0.5` \*RST value is 0.22

**[:SOURce]:WCDMa:FILTer:MODE LACP | LEVM**

This command selects one of the "L"ow filter modes.

Example: `:SOUR:WCDM:FILT:MODE LEVM` \*RST value is LACP

**[[:SOURCE]:WCDMA:LDISortion[:STATe] ON | OFF**

The command sets the reduced level for the low-distortion mode.

ON Low-distortion mode

OFF Normal level

Example: :SOUR:WCDM:LDIS ON

\*RST value is OFF

**[[:SOURCE]:WCDMA:SEQuence AUTO | RETRigger | AAUTo | ARETrigger**

The command selects the trigger mode for the W-CDMA sequence.

AUTO Continuously repeated

RETRigger Continuously repeated; new start after a trigger

AAUTo ARMED AUTO; waits for trigger, then switches over to AUTO and can no longer be triggered

ARETrigger ARMED RETRIG; a trigger event is required to start, each new trigger causes a restart

Example: :SOUR:WCDM:SEQ AAUT

\*RST value is RETR

**[[:SOURCE]:WCDMA:TRIGger:SOURce EXTernal | INTernal**

The command selects the trigger source. With INT selected, triggering is via remote control using the trigger command or via EXECUTE TRIGGER in case of manual control.

EXT The trigger signal is fed in via input TRIGIN

INT A start is only possible manually or via the remote control command TRIG:DM:IMM

Example: :SOUR:WCDM:TRIG:SOUR EXT

\*RST value is INT

**[[:SOURCE]:WCDMA:TRIGger:INHibit 0 to 67108863**

The command sets the retrigger inhibit duration (in number of chips).

Example: :SOUR:WCDM:TRIG:INH 1000

\*RST value is 0

**[[:SOURCE]:WCDMA:TRIGger:DELay 0 to 40959**

The command defines the trigger delay (in number of chips).

Example: :SOUR:WCDM:TRIG:DEL 200

\*RST value is 0

**[[:SOURCE]:WCDMA:TRIGger:OUTPut[1]2 SLOT | RFRame | CSPeriod**

The command defines the output signal at trigger output 1 or 2. The following times can be selected:

SLOT Time slot clock

RFRame Radio Frame (frame clock)

CSPeriod Chip Sequence Period

Example: :SOUR:WCDM:TRIG:OUTP1 RFR

\*RST value is: for OUTPut 1: RFR  
for OUTPut 2: CSP

**[[:SOURCE]:WCDMA:TRIGger:OUTPut[1]2:POLarity POSitive | NEGative**

The commands defines the polarity of the signals at the trigger outputs.

Example: :SOUR:WCDM:TRIG:OUTP2:POL NEG

\*RST value is POS



**[[:SOURce]:WCDMa:TRIGger:OUTPut[1]]2:DELay 0 to 40959 (81919)**

The command defines the delay of trigger signals in chips.

Example: :SOUR:WCDM:TRIG:OUTP2:DEL 50

\*RST value is 0

**[[:SOURce]:WCDMa:CLOCK:SOURce INTERNAL | EXTERNAL**

The command selects the clock source.

INTERNAL The internal clock generator is used.

EXTERNAL The clock is fed externally via connector SYMBOL CLOCK.

Example: :SOUR:WCDM:CLOC:SOUR EXT

\*RST value is INT

**[[:SOURce]:WCDMa:POWER?**

The command queries the total power for the W-CDMA signal.

Example: :SOUR:WCDM:POW?

**[[:SOURce]:WCDMa:POWER:ADJust**

The command modifies the power of each active code channel. This means that the total power is set equal to the power in the level display. The command triggers an action and hence has no \*RST value assigned.

Example: :SOUR:WCDM:POW:ADJ

**[[:SOURce]:WCDMa:MULTicode**

The commands for selecting multicode settings (not available with :WCDM:LINK UPMulti) are under this node.

**[[:SOURce]:WCDMa:MULTicode:STATE ON | OFF**

The command permits to switch on or off the multicode mode.

Example: :SOUR:WCDM:MULT:STAT OFF

**[[:SOURce]:WCDMa:MULTicode:MASTer 0 to 3**

The command selects the master channel for the spread code.

Example: :SOUR:WCDM:MULT:MAST 3

**[[:SOURce]:WCDMa:MULTicode:CHANnels #H0 to #HFF**

The command permits to select the channels for the multicode transmission. Each set bit in the 15-bit hex figure corresponds to a set channel. The figure 9, for example, switches on channel 0 (binary significance) and channel 3 (significance 8).

Example: :SOUR:WCDM:MULT:CHAN #H3A

**[[:SOURce]:WCDMa:SLENgth 1 to 256**

The command determines the length of the calculated chip sequence in number of frames.

Example: :SOUR:WCDM:SLEN 8

**[:SOURce]:WCDMA:CHANnel<0...14>[:I]:Q**

The commands for determining the channel configuration are under this node. For the sense of transmission DOWN (:WCDM:LINK DOWN) the settings cannot be separately set to I and Q component; :I and :Q need not be specified.

Example: :WCDM:CHAN2:TYPE PERC

For UP, however, there is the multiplex setting (UPMulti) with which settings are distinguished between I and Q. :I is optional, :I is used if no indication is made.

Example: :WCDM:CHAN2:I:TYPE PERC

has the same meaning as :WCDM:CHAN2:TYPE PERC

Example for Q-component setting: :WCDM:CHAN2:Q:TYPE PERC

There are some commands which do not make a distinction between I and Q:

:WCDM:CHAN<0...14>:LCOD

:WCDM:CHAN<0...14>:LCOD OFFS

:WCDM:CHAN<0...14>:SCOD:LMS

**[:SOURce]:WCDMA:CHANnel<0...14>[:I]:Q:TYPE PERCh | CCPCh | DPCH | DPDCh | DPCCh | ALLD**

The command selects the channel type.

PERCh Perch Channel (only for :WCDM:LINK DOWN)

CCPCh Common Control Physical Channel (not for :WCDM:LINK UPM)

DPCH Dedicated Physical Channel (not for :WCDM:LINK UPM)

ALLD All Data (not for :WCDM:LINK UPM)

DPDCh Dedicated Physical Data Channel (only for :WCDM:LINK UPM)

DPCCh Dedicated Physical Control Channel (only for :WCDM:LINK UPM)

Example: :SOUR:WCDM:CHAN2:I:TYPE PERC \*RST value is DPCH

\*RST value is PERC for channel 0, mode 8, downlink

**[:SOURce]:WCDMA:CHANnel<0...14>[:I]:Q:SRATe D16 | D32 | D64 | D128 | D256 | D512 | D1024**

The command determines the symbol rate. The values depend on the channel type.

Example: :SOUR:WCDM:CHAN2:I:SRAT D64 \*RST value is D32

\*RST value is 16 for channel 0, mode 8, downlink

**[:SOURce]:WCDMA:CHANnel<0...14>[:I]:Q:SCODE 0 to 511**

The command is used to set the short code of the spread code. The upper limit depends on :WCDM:CRAT, :WCDM:SRAT and :WCDM:CHAN:TYPE.

Example: :SOUR:WCDM:CHAN2:I:SCOD 123 \*RST value is (<chan>+9)

\*RST value is 0 for channel 0, mode 8, downlink

**:SOURce]:WCDMA:CHANnel<0...14>:LCODE #H0 to #H3FFFF (#H1FFFFFFFF)**

The command determines the long code of the spread code.

Example: :SOUR:WCDM:CHAN2:LCOD #H3FFF \*RST value is #H1

**[:SOURce]:WCDMA:CHANnel<0...14>:LCODE:OFFSet 0 to 40959 (81919)**

The command is used to set the long code offset of the spread code.

Example: :SOUR:WCDM:CHAN2:LCOD:OFFS 345 \*RST value is 0

**[[:SOURce]:WCDMa:CHANnel<0...14>:SCODE:LMS #H0 to #HFF**

The command determines the short code index used for the spreading of the long code mask symbols (LMS).

Example:     : SOUR : WCDM : CHAN2 : SCOD : LMS #H3F                             \*RST value is #H1

**[[:SOURce]:WCDMa:CHANnel<0...14>[:I]]:Q:POWer -30dB to 0dB**

The command determines the power of a channel in relation to the power indication on the level display. Setting limitations are to be observed with respect to :WCDM:MODE CHANx.

Example:     : SOUR : WCDM : CHAN2 : I : POW -22 DB                             \*RST value is -9

**[[:SOURce]:WCDMa:CHANnel<0...14>[:I]]:Q:DATA PN9 | PN11 | PN15 | PN16 | DLIS**

The command is used to determine the data source for the data field. PNx are PRBS data and DLIS data from a list previously defined. It is selected with the following command.

Example:     : SOUR : WCDM : CHAN2 : I : DATA DLIS                             \*RST value is PN15

**[[:SOURce]:WCDMa:CHANnel<0...14>[:I]]:Q:DATA:DLIS 'name'**

The command selects the data list used with :WCDM:CHAN:DATA DLIS. The command has no \*RST value.

Example:     : SOUR : WCDM : CHAN2 : I : DATA : DLIS 'test2'

**[[:SOURce]:WCDMa:CHANnel<0...14>[:I]]:Q:DATA:OFFSet 0 to 10239**

The command is used to set the data offset (unit symbol duration). It shifts the modulation data with respect to the spread code.

Example:     : SOUR : WCDM : CHAN2 : I : DATA : OFFS 345                             \*RST value is (<chan> \* 3)  
   \*RST value is 0 for channel 0, mode 8, downlink

**[[:SOURce]:WCDMa:CHANnel<1...14>:TPC ZERO | ONE | ALTErnate | DLIS**

The command determines the data source for the TPC field in channel types DPCH and DPCCh.

ZERO        0000..., sequence of zeros

ONE         1111..., sequence of ones

ALT         alternating sequence

DLIS        Data from a list previously defined.

Example:     : SOUR : WCDM : CHAN2 : TPC DLIS                             \*RST value is ALT

**[[:SOURce]:WCDMa:CHANnel<1...14>:TPC:DLIS 'name'**

The command selects the data list used with :WCDM:CHAN:TPC DLIS. The command has no \*RST value.

Example:     : SOUR : WCDM : CHAN2 : TPC DLIS 'test1'

**[[:SOURce]:WCDMa:CHANnel<0...14>:STATe ON | OFF**

Switches the assigned code channel on or off.

Example:     : SOUR : WCDM : CHAN12 : STAT ON                             \*RST value is ON



Command	Parameter	Default Unit	Remark
[[:SOURce]			
:W3GPP			
:COPI			
:SOURce	1 to 4		
:DESTination	1 to 4		
:COFFset	0 to 511		Only for LINK DOWN
:EXECute	(without)		
:SEQUence	AUTO   RETRigger   AAUTO   ARETrigger		
:TRIGger			
:SOURce	EXTernal   INTernal		
:DELay	0 to 38399	(chips)	
:INHibit	0 to 67108863	(chips)	
:OUTPut[1] 2	SLOT   RFRame   CSPeriod   ECSPeriod		
:POLarity	POS   NEG		
:DELay	0 to 38399	(chips)	
:CLOCK			
:SOURce	EXTernal   INTernal		
:MODE	CHIP   CHIP4		
:DELay	0 to 0.99	(chips)	
:POWER?		dB	Query only
:ADJust	(without)		
:BSTation<i>	with i = [1]   2   3   4		Base station
:STATE	ON   OFF		
:SCODE	#H0 to #H5FFF		
:STATE	ON   OFF		
:TFCI	0 to 1023		
:STATE	ON   OFF		
:SSCG?	⇒ 0 to 63		query only
:TPC			
:READ	CONTInuous   S0A   S1A   S01A   S10A		
:MISuse	ON   OFF		
:POWER			
:STEP	-10 to +10	dB	
:TRANsmit			
:DIVersity	OFF   ANT1   ANT2		
:PINDicator			
:COUNt	D18   D36   D72   D144		Multichannel
:MCHannel			
:STARt	11 to 138		
:STOP	11 to 138		
:SRATE	D7K5   D15K   D30K   D60K   D120K   D240K   D480K   D960K	(S/s)	
:PLENght	BIT2   BIT4   BIT8   BIT16		
:CCODE	0 to (511)		
:STEP	0 to (511)		
:POWER	-60 to 0	dB	
:STEP	-60 to +60	dB	
:DATA	PN9   PN11   PN15   PN16   ZERO   ONE   PATtern		
:PATTern	#B0 to B111..1, 1 to 24		

Command	Parameter	Default Unit	Remark
[[:SOURce]			
:W3GPP			
:MCHannel			Multichannel
:TIMing			
:OFFSet	0 to 149		
:STEP	0 to 149		
:TPC	ZERO   ONE   PATtern		
:PATtern	#B0 to B111..1, 1 to 24		
:MCODe	ON   OFF		
:STATe	ON   OFF		
:BSTation<i>	with i = [1]   2   3   4		Base station
:MCHannel			Multichannel
:EXECute	(without)		
:ENHanced	(only with SMIQB48, WCDMA Enhanced Channels)		
:OCNS	(only with SMIQB48, WCDMA Enhanced Channels)		
:CHANnel<n>	with n = 0   [1]   2 to 138		
:SRATe	D7K5   D15K   D30K   D60K   D120K   D240K   D480K   D960K	(S/s)	
:CCODe	0 to (511)		
:POWeR	-60.0 to 0	dB	
:DATA	PN9   PN11   PN15   PN16   ZERO   ONE   PATtern		
:PATtern	#B0 to B111..1, 1 to 24		
:TOFFset	0 to 149		
:PLENght	BIT2   BIT4   BIT8   BIT16		
:TPC	ZERO   ONE   PATtern		
:PATtern	#B0 to B111..1, 1 to 24		
:MCODe	ON   OFF		
:STATe	ON   OFF		
:DOMain	ON   OFF		
:ERRor?	=> 0   1		Query only
:MSTation<i>	with i = [1]   2   3   4		Mobile station
:STATe	ON   OFF		
:MODE	PRACH   PCPCh   DPCDch		
:SCODe	#H0 to #FFFFFFF		
:MODE	LONG   SHORt   OFF		
:TPC			
:DATA	ZERO   ONE   PATtern (  DLISt)		
:PATtern	#B0 to B111..1, 1 to 24		
:READ	CONTInuous   S0A   S1A   S01A   S10A		
:PRACH			
:PREPetition	1 to 10		
:PPOWeR	-60 to 0	dB	
:DPOWeR	-60 to 0	dB	
:CPOWeR	-60 to 0	dB	
:MLENght	1   2		Message part
:SIGNature	0 to 15		
:ASLot	0 to 14		
:SRATe	D15K   D30K   D60K   D120K		



**Note:** *The calculation of the W-CDMA sequences is rather time-consuming and should be re-started for any new setting. The WCDMA modulation is therefore switched off for each command (autom. :SOUR:W3GP:STAT OFF performed). The user can then perform several settings without any delay and has to switch on again the WCDMA modulation (with :SOUR:W3GP:STAT ON). The calculations are performed and the previous settings are effective after the command is given.*

#### **[[:SOURce]:W3GPP:CALCulate:PROGress?**

The command queries the calculation status. The value is returned in percent.

Example: :SOUR:W3GP:CALC:PROG

#### **[[:SOURce]:W3GPP:STATe ON | OFF**

The command switches on the modulation in line with the W-CDMA procedure (3GPP standard). Option SMIQB45 is required for this purpose. All other standards that are switched on or the digital modulation are automatically switched to off state.

**Caution:** The command with ON should be used after any :SOUR:W3GP command or after a series of W3GP commands in order to activate the previous settings.

Example: :SOUR:W3GP:STAT ON (or :SOUR:W3GP:STAT ON) \*RST value is OFF

#### **[[:SOURce]:W3GPP:PRESet**

The command sets all the following settings to a defined initial state (as after \*RST). This ensures that a signal is actually generated and that it is in line with the standard. This command triggers an event and hence has no \*RST value and no query.

Example: :SOUR:W3GP:PRES

#### **[[:SOURce]:W3GPP:SETTing:CATalog? =>'name'**

The command returns a list of all user-defined sequence configurations.

Example: :SOUR:W3GP:SETT:CAT? Response: 'test1', 'test2'

#### **[[:SOURce]:W3GPP:SETTing:LOAD 'name of sequence'**

The command loads a user-defined sequence configuration. The name may have a maximum number of 8 characters. This command triggers an action and hence has no \*RST value.

Example: :SOUR:W3GP:SETT:LOAD 'test'

#### **[[:SOURce]:W3GPP:SETTing:STORE 'name of sequence'**

The command stores a current sequence configuration under a name. The name may contain a maximum of 8 letters. This command triggers an action and so has no \*RST value and no query.

Example: :SOUR:W3GP:SETT:STOR 'test'



**[[:SOURce]:W3GPP:SETTing:DELeTe 'name of sequence']**

The command deletes the specified sequence configuration. This command triggers an action and so has no \*RST value and no query.

Example: :SOUR:W3GP:SETT:DEL 'test1'

**[[:SOURce]:W3GPP:SETTing:TMODeI]**

The commands for default setting (test models) are under this node.

**[[:SOURce]:W3GPP:SETTing:TMODeI[:BST] 'name']**

The command loads a default setting (test model) defined in 3GPP standard TS25.141 for the base station, i.e. for link direction FORW. This command triggers an action and hence has no \*RST value.

TEST1\_16 Spectrum emission mask ACLR; 16 Channels)  
 TEST1\_32 Spectrum emission mask ACLR; 32 Channels)  
 TEST1\_64 Spectrum emission mask ACLR; 64 Channels)  
 TEST2 Output power dynamics  
 TEST3\_16 Peak code domain error; 16 Channels  
 TEST3\_32 Peak code domain error; 32 Channels  
 TEST4

Example: :SOUR:W3GP:SETT:TMOD 'TEST1\_32'

**[[:SOURce]:W3GPP:SETTing:TMODeI[:BST]:CATalog?]**

The command returns a list of all the available test models for the base station, i.e. for link direction FORW.

Example: :SOUR:W3GP:SETT:TMOD:CAT?

**[[:SOURce]:W3GPP:SETTing:TMODeI:MST 'name']**

The command loads a non-standardized default setting (test model) for the mobile station, i.e. for link direction REV. This command triggers an action and hence has no \*RST value.

,C+D 60K  
 ,C+D960K

Example: :SOUR:W3GP:SETT:TMOD:MST 'C+D 60K'

**[[:SOURce]:W3GPP:SETTing:TMODeI[:MST]:CATalog?]**

The command returns a list of all the available test models for the mobile station, i.e. for link direction REV.

Example: :SOUR:W3GP:SETT:TMOD:MST:CAT?

**[[:SOURce]:W3GPP:GPP3:VERSion?]**

The command queries the version.

Example: :SOUR:W3GP:GPP3:VERS?

Response: (V3420)

**[[:SOURce]:W3GPP:CRATe?]**

The command queries the chip rate.

Example: :SOUR:W3GP:CRAT?

Response: (R3M84)

**[ :SOURCE]:W3GPP:LINK FORWARD | REVERSE**

The command selects the mode of the transmitted signal (sense of transmission). The signal either corresponds to that of a base station (FORWARD, alias DOWN) or a mobile station (REVERSE, alias UP).

Example:     : SOUR:W3GP:LINK REV                             \*RST value is FORW

**[ :SOURCE]:W3GPP:SLENGTH 1 to 13**

The command defines the length of the calculated chip sequence as a number of frames.

Example:     : SOUR:W3GP:SLEN 8                                 \*RST value is 1

**[ :SOURCE]:W3GPP:CLIPPING:LEVEL 1 to 100PCT**

The command limits the output level (referred to the unlimited level). Can only be set if the Enhanced Channels are switched off.

Example:     : SOUR:W3GP:CLIP:LEV 95

**[ :SOURCE]:W3GPP:FILTER:TYPE SCOSine | COSine | WCDMa | USER**

The command selects the filter type. A filter list should be selected with :W3GP:FILT:SEL 'name' for the filter type USER.

SCOSine     square root cosine (root Nyquist) filter

COSine      cosine (Nyquist) filter

WCDMa      root Nyquist filter with fixed roll-off factor 0.22

USER        user-defined list

Example:     : SOUR:W3GP:FILT:TYP COS                         \*RST value is WCDM

**[ :SOURCE]:W3GPP:FILTER:SELEct 'name'**

The command selects a named filter list. The list is used only if a user-defined filter is selected with :W3GPP:FILT:TYPE USER. To generate lists, cf. command [:SOURCE]:DM:FLIST:SEL, to fill up lists, cf. command [:SOURCE]:DM:FLIST:DATA.

Example:     : SOUR:SOUR:W3GP:FILT:SEL 'test'                 \*RST value is NONE

**[ :SOURCE]:W3GPP:FILTER:PARAMeter 0.1 to 0.99**

The command sets the roll-off factor for the COS and SCOS filters.

Example:     : SOUR:W3GP:FILT:PAR 0.5                         \*RST value is 0.22

**[:SOURce]:W3GPp:FILTer:MODE LACP | LEVM**

This command selects one of the "L"ow filter modes (LACP: lowest adjacent channel power, LEVM: lowest error vector).

Example: `:SOUR:W3GP:FILT:MODE LEVM` \*RST value is LACP

**[:SOURce]:W3GPp:CRATe:VARiation 100 Hz to 18 MHz (cps)**

The command selects the variation for the chip rate frequency (as against that set with `:SOUR:W3GP:CRAT`).

Example: `:SOUR:W3GP:CRAT:VAR 1.2MHz` \*RST value is 3.84M

**[:SOURce]:W3GPp:PPARameter**

The commands for the parameterizable predefined settings are under this node. The channel table is filled (preset) with the following parameters, if the `:SOUR:W3GP:PPAR:EXEC` action command is executed.

**[:SOURce]:W3GPp:PPARameter:SCHannels ON | OFF**

The channels (P-CPICH, P-SCH, S-SCH, PCCPCH) required for the synchronization of the mobile are switched on (ON) or remain unused (OFF).

Example: `:SOUR:W3GP:PPAR:SCH OFF` \*RST value is ON

**[:SOURce]:W3GPp:PPARameter:SCCPch:STATe ON | OFF**

SCCPCH is used in the scenario (ON) or remains unused (OFF).

Example: `:SOUR:W3GP:PPAR:SCCP:STAT OFF` \*RST value is ON

**[:SOURce]:W3GPp:PPARameter:SCCPch:SRATe D15K | D30K | D60K | D120K | D240K | D480K | D960K**

The symbol rate of S-CCPCH is set. The permissible rates depend on the channel type.

Example: `:SOUR:W3GP:PPAR:SCCP:SRATE D120K` \*RST value is D60K

**[:SOURce]:W3GPp:PPARameter:DPCH:COUNt 0 to 512**

The command sets the number of DPCH channels. The maximum number depends on the chip rate and the symbol rate.

Example: `:SOUR:W3GP:PPAR:DPCH:COUN 16` \*RST value is 3

**[:SOURce]:W3GPp:PPARameter:SRATe D7K5 | D15K | D30K | D60K | D120K | D240K | D480K | D960K**

The command sets the symbol rate of DPCH channels. The permissible rates depend on the type of channel.

Example: `:SOUR:W3GP:PPAR:SRAT D240K` \*RST value is D30K

**[:SOURce]:W3GPp:PPARameter:CRESt MINimum | AVERage | WORSt**

The command sets the crest factor. MIN sets the timing offset and channelization code so that they are minimized. An average value is generated with AVG, the highest value of the crest factor with MAX.

Example: `:SOUR:W3GP:PPAR:CRES WORS` \*RST value is MIN

**[:SOURce]:W3GPp:PPARameter:EXECute**

This action command fills (presets) the channel table with the above parameters.

Example: `:SOUR:W3GP:PPAR:EXEC`

**[[:SOURce]:W3GPp:COPI**

The commands for copying the setting of a mobile or base station to the data record of another are under this node. The `:SOUR:W3GP:COPI:EXEC` command starts copying.

**[[:SOURce]:W3GPp:COPI:SOURce 1 to 4**

The command selects the station whose data are to be copied.

Example: `:SOUR:W3GP:COPI:SOUR 2`

**[[:SOURce]:W3GPp:COPI:DESTination 1 to 4**

The command selects the station to which data are to be copied.

Example: `:SOUR:W3GP:COPI:DEST 3`

**[[:SOURce]:W3GPp:COPI:COFFset 0 to 511**

The command sets the offset value for the channelization code in the target station. This command is only available under `:SOUR:W3GP:LINK FORW/DOWN`.

Example: `:SOUR:W3GP:COPI:SOFF 100`

**[[:SOURce]:W3GPp:COPI:EXECute**

The command starts copying.

Example: `:SOUR:W3GP:COPI:EXEC`

**[[:SOURce]:W3GPp:SEQence AUTO | RETRigger | AAUTO | ARETrigger**

The command selects the trigger mode for the W-CDMA sequence.

AUTO Continuously repeated

RETRigger Continuously repeated; new start after a trigger

AAUTO ARMED AUTO; waits for trigger, then switches over to AUTO and can no longer be triggered

ARETrigger ARMED RETRIG; a trigger event is required to start, each new trigger causes a restart

Example: `:SOUR:W3GP:SEQ AAUT` \*RST value is RETR

**[[:SOURce]:W3GPp:TRIGger:SOURce EXTERNAL | INTERNAL**

The command selects the trigger source. With INT selected, triggering is via remote control using the trigger command or via EXECUTE TRIGGER in case of manual control.

EXT The trigger signal is fed in via input TRIGIN

INT A start is only possible manually or via the remote control command `TRIG:DM:IMM`

Example: `:SOUR:W3GP:TRIG:SOUR EXT` \*RST value is INT

**[[:SOURce]:W3GPp:TRIGger:DElay 0 to 38399**

The command defines the trigger delay (in number of chips).

Example: `:SOUR:W3GP:TRIG:DEL 200` \*RST value is 0

**[[:SOURce]:W3GPp:TRIGger:INHibit 0 to 67108863**

The command sets the retrigger inhibit duration (in number of chips).

Example: `:SOUR:W3GP:TRIG:INH 1000` \*RST value is 0

**[[:SOURce]:W3GPP:TRIGger:OUTPut[1]|2 SLOT | RFRame | CSPeriod | ECSPeiod | SFNR**

The command defines the output signal at trigger output 1 or 2. The following times can be selected:

- SLOT Time slot clock
- RFRame Radio Frame (frame clock)
- CSPeriod Chip Sequence Period
- ECSPeiod Enhanced Chip Sequence Period (only with option SMIQB48)
- SFNR P-CCPCH/BCH SFN Restart

Example: :SOUR:W3GP:TRIG:OUTP RFR \*RST value is: for OUTPut 1: RFR  
for OUTPut 2: CSP

**[[:SOURce]:W3GPP:TRIGger:OUTPut[1]|2:POLarity POSitive | NEGative**

The commands defines the polarity of the signals at the trigger outputs.

Example: :SOUR:W3GP:TRIG:OUTP2:POL NEG \*RST value is POS

**[[:SOURce]:W3GPP:TRIGger:OUTPut[1]|2:DELay 0 to 38399**

The command defines the delay of trigger signals in chips.

Example: :SOUR:W3GP:TRIG:OUTP2:DEL 50 \*RST value is 0

**[[:SOURce]:W3GPP:CLOCK:SOURce INTernal | EXTernal**

The command selects the clock source.

- INTernal The internal clock generator is used.
- EXTernal The clock is fed externally via connector SYMBOL CLOCK.

Example: :SOUR:W3GP:CLOC:SOUR EXT \*RST value is INT

**[[:SOURce]:W3GPP:CLOCK:MODE CHIP | CHIP4**

The command selects the clock rate for the external chip clock. With CHIP4, the clock has four times the rate.

Example: :SOUR:W3GP:CLOC:MODE CHIP4 \*RST value is CHIP

**[[:SOURce]:W3GPP:CLOCK:DELay 0 to 0.99**

The command sets the delay of the clock signal in chips.

Example: :SOUR:W3GP:CLOC:DEL 0.5 \*RST value is 0

**[[:SOURce]:W3GPP:POWER?**

The command queries the total power for the W-CDMA signal.

Example: :SOUR:W3GP:POW?

**[[:SOURce]:W3GPP:POWER:ADJust**

The command changes the power of the activated code channels. The total power then equals the power shown by the Level display (total power). This command triggers an action and so has no \*RST value and no query form.

Example: :SOUR:W3GP:POW:ADJ

**[[:SOURce]:W3GPP:BSTation<i> where i = [1] | 2 | 3 | 4**

This node comprises commands for one of the 4 base stations. They are only effective if the link direction is set to FORW. (:SOUR:W3GP:LINK FORW).

**[[:SOURce]:W3GPp:BSTation<i>:STATe ON | OFF**

The command activates the station with ON and deactivates it with OFF.

Example: :SOUR:W3GP:BST2:STAT ON

\*RST value is OFF

**[[:SOURce]:W3GPp:BSTation<i>:SCODE #H0 to #H5FFF**

The command sets the scrambling coder of a station.

Example: :SOUR:W3GP:BST:SCOD #H1234

\*RST value is #H0

**[[:SOURce]:W3GPp:BSTation<i>:SCODE:STATe #H0 to #H5FFF**

The command sets the Scrambling Code of a station.

Example: :SOUR:W3GP:BST:SCOD #H1234

\*RST value is #H0

**[[:SOURce]:W3GPp:BSTation<i>:TFCI 0 to 1023**

The command sets the value of the transport format identifier.

Example: :SOUR:W3GP:BST2:TFCI 22

\*RST value is 0

**[[:SOURce]:W3GPp:BSTation<i>:TFCI:STATe ON | OFF**

The command activates the transport format identifier (ON) or deactivates it (OFF).

Example: :SOUR:W3GP:BST3:TFCI:STAT ON

\*RST value is OFF

**[[:SOURce]:W3GPp:BSTation<i>:SSCG?**

The command queries the 2nd search code group (PERCH).

Example: :SOUR:W3GP:BST4:SSCG?

**[[:SOURce]:W3GPp:BSTation<i>:TPC:READ CONTInuous | S0A | S1A | S01A | S10A**

The command sets the read-out mode for the TPC pattern.

CONTInuous TPC is used cyclically.

S0A TPC is used once, followed by 0 bits.

S1A TPC is used once, followed by 1 bits.

S01A TPC is used once, followed by alternating 01 bits.

S10A TPC is used once, followed by alternating 10 bits.

Example: :SOUR:W3GP:BST:TPC:READ S01A

\*RST value is CONT

**[[:SOURce]:W3GPp:BSTation<i>:TPC:MISuse ON | OFF**

The command sets the misuse of the TPC pattern of each channel for the channel power control.

Example: :SOUR:W3GP:BST:TPC:MIS ON

\*RST value is OFF

**[[:SOURce]:W3GPp:BSTation<i>:TPC:POWER:STEP -10.0 to 10.0 dB**

The command sets the channel-power step width when option :SOUR:W3GP:BST:MIS:TPC ON is active.

Example: :SOUR:W3GP:BST:TPC:POW:STEP 3.1

\*RST value is 0

**[:SOURce]:W3GPP:BSTation<i>:TRANsmit:DIVersity OFF | ANT1 | ANT2**

This command sets the calculation of the signal without transmit diversity (OFF) or for antenna 1, or antenna 2 (SCH channels with TSTD mode, other channels with STTD mode).

Example: `:SOUR:W3GP:BST:TRAN:DIV ANT2` \*RST value is OFF

**[:SOURce]:W3GPP:BSTation:PINDicator:COUNT D18 | D36 | D72 | D144**

The command sets the number of PI in the page indicator channel (PICH).

Example: `:SOUR:W3GP:BST:PIND:COUN D16` \*RST value is 18

**[:SOURce]:W3GPP:MCHannel**

The commands for the common setting of several DPCH channels are under this node (multichannel). All channels with the numbers between start and stop are simultaneously set to the value of the following commands by means of the `:SOUR:W3GP:BST<i>:MCH:EXEC` action command.

**[:SOURce]:W3GPP:MCHannel:STARt 11 to 138**

The command specifies the initial channel of the group with common setting.

Example: `:SOUR:W3GP:MCH:STAR 12` \*RST value is 11

**[:SOURce]:W3GPP:MCHannel:STOP 11 to 138**

The command specifies the end channel of the group with common setting.

Example: `:SOUR:W3GP:MCH:STOP 129` \*RST value is 11

**[:SOURce]:W3GPP:MCHannel:SRATe D7K5 | D15K | D30K | D60K | D120K | D240K | D480K | D960K**

This command defines the symbol rate. The values depend on the channel type.

Example: `:SOUR:W3GP:MCH:SRAT D60K` \*RST value is D30K

**[:SOURce]:W3GPP:MCHannel:PLENght Bit2 | Bit4 | Bit8 | Bit16**

The command sets the length of the pilot field in bits. The range of values depends on the symbol rate.

Example: `:SOUR:W3GP:MCH:PLEN BIT2` \*RST value is BIT4

**[:SOURce]:W3GPP:MCHannel:CCODE 0 to (511)**

This command sets the channel code. The upper limit depends on the channel type and the symbol rate.

Example: `:SOUR:W3GP:MCH:CCOD 123` \*RST value is 0

**[:SOURce]:W3GPP:MCHannel:CCODE:STEP 0 to (511)**

This command sets the step width of the channel code. The upper limit depends on the channel type and the symbol rate.

Example: `:SOUR:W3GP:MCH:CCOD:STEP 123` \*RST value is 0

**[:SOURce]:W3GPP:MCHannel:POWer –60 dB to 0 dB**

The power of a channel compared to the powers of other channels is determined.

Example: `:SOUR:W3GP:MCH:POW –22DB` \*RST value is 0 dB

**[[:SOURce]:W3GPp:MCHannel:POWer:STEP -60 dB to +60 dB**

The step width for the power of a channel compared to the powers of other channels is determined.

Example: `:SOUR:W3GP:MCH:POW:STEP -22DB` \*RST value is 0 dB

**[[:SOURce]:W3GPp:MCHannel:DATA PN9 | PN11 | PN15 | PN16 | ZERO | ONE | PATTern**

This command defines the data source for the data field. PNx is PRBS data and PATT is a pattern which is set with the following command. ZERO sets all bits to 0, ONE sets all bits to 1.

Example: `:SOUR:W3GP:MCH:DATA PATT` \*RST value is PN15

**[[:SOURce]:W3GPp:MCHannel:DATA:PATTern #B0 to B111..1, 1 to 24**

This command sets the pattern which is used under `:SOUR:W3GP:BST3:MCH:DATA PATT`. The first parameter sets the bit pattern (optionally Hex, Oct or Bin syntax), the second one indicates the number of bits to be used.

Example: `:SOUR:W3GP:MCH:DATA:PATT #H3F, 8` \*RST value is #H0, 1

**[[:SOURce]:W3GPp:MCHannel:TIMing:OFFSet 0 to 149**

This command sets the timing offset. It offsets the modulation data with respect to the scrambling code.

Example: `:SOUR:W3GP:MCH:TIM:OFFS 345` \*RST value is 0

**[[:SOURce]:W3GPp:MCHannel:TIMing:OFFSet:STEP 0 to 149**

This command sets the step width of the timing offset.

Example: `:SOUR:W3GP:MCH:TIM:OFFS:STEP 345` \*RST value is 0

**[[:SOURce]:W3GPp:MCHannel:TPC ZERO | ONE | PATTern**

This command defines the data source for the TPC field in DPCH.

ZERO 0000..., sequence of zeroes

ONE 1111..., sequence of ones

PATTern bit pattern set with the following command

Example: `:SOUR:W3GP:MCH:TPC PATT` \*RST value is ZERO

**[[:SOURce]:W3GPp:MCHannel:TPC:PATTern #B0 to B111..1, 1 to 24**

This command sets the bit pattern which is used under `:SOUR:W3GP:BST3:MCHan:TPC PATT`. The first parameter sets the bit pattern (optionally Hex, Oct or Bin syntax), the second one indicates the number of bits to be used.

Example: `:SOUR:W3GP:MCH:TPC:PATT #H3F, 8` \*RST value is #H0, 1

**[[:SOURce]:W3GPp:MCHannel:MCODE ON | OFF**

The command activates the multicode for the channel (ON) or deactivates it (OFF).

Example: `:SOUR:W3GP:MCH:MCOD ON` \*RST value is OFF

**[[:SOURce]:W3GPp:MCHannel:STATe ON | OFF**

The command activates the code channels (ON) or deactivates them (OFF).

Example: `:SOUR:W3GP:MCH:STAT OFF` \*RST value is ON



**[:SOURce]:W3GPP:BSTation<i>:MCHannel:EXECute**

All channels with the numbers between start and stop are simultaneously set to the value of the above :SOUR:W3GP:MCH commands.

Example: :SOUR:W3GP:BST3:MCH:EXEC

**[:SOURce]:W3GPP:BSTation<i>:ENHanced....**

The commands for setting the enhanced functions for the 3GPP W-CDMA standard are under this node. These commands are only available if option SMIQB48 is installed. For further information see remote-control commands of this option.

**[:SOURce]:W3GPP:BSTation<i>:OCNS....**

The commands for simulating the orthogonal channel noise are under this node. These commands are only available if option SMIQB48 is installed. For further information see manual on remote-control commands of this option.

**[:SOURce]:W3GPP:BSTation<i>:CHANnel<n>** with n = 0 | [1] | 2 to 138

The commands for determining the channel configuration are under this node. Suffix 1 is optional. For channels 0 to 10 not all commands are available (settable).

**[:SOURce]:W3GPP:BSTation<i>:CHANnel<n>:SRATe** D7K5 | D15K | D30K | D60K | D120K | D240K | D480K | D960K

This command defines the symbol rate. The permissible rates depend on the type of channel.

Example: :SOUR:W3GP:BST:CHAN2:SRAT D60K  
\*RST value is mostly D15K (see manual control)

**[:SOURce]:W3GPP:BSTation<i>:CHANnel<n>:CCODE** 0 to 511

This command sets the channelization code. The upper limit depends on the symbol rate and the channel type and cannot be set for P-SCH and S-SCH.

Example: :SOUR:W3GP:BST1:CHAN3:CCOD 123 \*RST value is mostly 0 (see manual control)

**[:SOURce]:W3GPP:BSTation<i>:CHANnel<n>:POWER** -60 dB to 0 dB

The power of a channel compared to the powers of other channels is determined.

Example: :SOUR:W3GP:BST2:CHAN4:POW -22DB \*RST value is 0

**[:SOURce]:W3GPP:BSTation<i>:CHANnel<n>:DATA** PN9 | PN11 | PN15 | PN16 | ZERO | ONE | PATTern

This command defines the data source for the data field. PNx is PRBS data and PATT is a pattern which is set with the following command. ZERO sets all bits to 0, ONE sets all bits to 1.

Example: :SOUR:W3GP:BST3:CHAN5:DATA PATT \*RST value is PN15

**[:SOURce]:W3GPP:BSTation<i>:CHANnel<n>:DATA:PATTern** #B0 to B111..1, 1 to 24

This command sets the pattern which is used under :SOUR:W3GP:BST:CHAN:DATA PATT. The first parameter sets the bit pattern (optionally Hex, Oct or Bin syntax), the second one indicates the number of bits to be used.

Example: :SOUR:W3GP:BST:CHAN2:DATA:PATT #H3F, 8 \*RST value is #H0, 1

**[[:SOURCE]:W3GPP:BSTation<i>:CHANnel<n>:TOFFset 0 to 149**

This command sets the timing offset. It offsets the modulation data with respect to the scrambling code.

Example: :SOUR:W3GP:BST2:CHAN6:TOFF 345 \*RST value is 0

**[[:SOURCE]:W3GPP:BSTation<i>:CHANnel<n>:TPC ZERO | ONE | PATTern**

This command defines the data source for the TPC field in DPCH.

ZERO 0000..., sequence of zeroes

ONE 1111..., sequence of ones

PATTern bit pattern set with the following command

Example: :SOUR:W3GP:BST3:CHAN7:TPC PATT \*RST value is ZERO

**[[:SOURCE]:W3GPP:BSTation<i>:CHANnel<n>:PLENght BIT2 | BIT4 | BIT8 | BIT16**

The command sets the length of the pilot field in bits. The range of values depends on the symbol rate.

Example: :SOUR:W3GP:BST:CHAN2:PLEN BIT4  
\*RST value is mostly bit4 (see manual control)

**[[:SOURCE]:W3GPP:BSTation<i>:CHANnel<n>:TPC:PATTern #B0 to B111..1, 1 to 24**

This command sets the bit pattern which is used under :SOUR:W3GP:BST:CHAN:TPC PATT. The first parameter sets the bit pattern (optionally Hex, Oct or Bin syntax), the second one indicates the number of bits to be used.

Example: :SOUR:W3GP:BST4:CHAN2:TPC:PATT #H3F, 8 \*RST value is #H0, 1

**[[:SOURCE]:W3GPP:BSTation<i>:CHANnel<n>:MCODe ON | OFF**

The command switches the multicode for the channel on or off.

Example: :SOUR:W3GP:BST:CHAN3:MCOD ON \*RST value is OFF

**[[:SOURCE]:W3GPP:BSTation<i>:CHANnel<n>:STATe ON | OFF**

The command switches the assigned code channel on or off.

Example: :SOUR:W3GP:BST2:CHAN4:STAT OFF \*RST value is OFF

**[[:SOURCE]:W3GPP: BSTation<i>:DOMain:ERRor?**

The command queries whether there is a conflict in the hierarchically structured spreading codes (response 1) or not (response 0). The cause can be pinpointed with manual control.

Example: :SOUR:W3GP:BST2:DOM:ERR?

**[[:SOURCE]:W3GPP:MSTation<i>:STATe ON | OFF**

The command activates the mobile station (ON) or deactivates it (OFF).

Example: :SOUR:W3GP:MST2:STAT ON \*RST value is ON (for MST1), OFF (for 2 to 4)

**[[:SOURCE]:W3GPP:MSTation<i>:MODE PRACH | PCPCh | DPCDch**

The command sets the mode of the mobile station. Depending on this mode, another group of commands is relevant for the generation of the output signal.

PRACH Physical Random Access Channel

PCPCh Physical Common Packet Channel

DPCDch DPCCCh and DPDCh (Standard mode)

Example: :SOUR:W3GP:MST3:MODE PRAC \*RST value is DPCD

**[:SOURce]:W3GPP:MSTation<i>:SCODE #H0 to #FFFFFF**

The command sets the scrambling code generator.

Example: `:SOUR:W3GP:MST3:SCOD #H1234`

\*RST value is #H0

**[:SOURce]:W3GPP:MSTation<i>:SCODE:MODE LONG | SHORt | OFF**

The command sets the mode of the scrambling code generator. SHORt can only be set under `:W3GP:MST:MODE DPcD`.

Example: `:SOUR:W3GP:MST3:SCOD:MODE SHOR`

\*RST value is LONG

**[:SOURce]:W3GPP:MSTation<i>:TPC:DATA ZERO | ONE | PATTern (| DLISt)**

The command selects the data source for the TPC field.

ZERO 0 data are continuously generated.

ONE 1 data are continuously generated.

PATT bit pattern set with the following command is used.

DLISt only in mobile station 1 and with option SMIQB48 built in (see section 2.15).

Example: `:SOUR:W3GP:MST3:TPC:DATA ZERO`

\*RST value is ZERO

**[:SOURce]:W3GPP:MSTation<i>:TPC:PATTern #B0 to B111..1, 1 to 24**

This command sets the bit pattern. It is only used if `:W3GP:MST:TPC:DATA PATT` is set. The first parameter sets the bit pattern (optionally Hex, Oct or Bin syntax), the second one indicates the number of bits to be used.

Example: `:SOUR:W3GP:MST3:TPC:PATT #H3F, 8`

\*RST value is 0, 1

**[:SOURce]:W3GPP:MSTation<i>:TPC:READ CONTInuous | S0A | S1A | S01A | S10A**

The command sets the read-out mode for the TPC pattern. 1 bit each is read out from the pattern.

CONTInuous TPC is used cyclically.

S0A TPC is used once, followed by 0 bits.

S1A TPC is used once, followed by 1 bits.

S01A TPC is used once, followed by alternating 01 bits.

S10A TPC is used once, followed by alternating 10 bits.

Example: `:SOUR:W3GP:MST3:TPC:READ S01A`

\*RST value is CONT

**[:SOURce]:W3GPP:MSTation<i>:PRACH...**

Commands for setting the physical random access channel are under this node. The commands are only relevant under `:W3GP:MST:MODE PRAC`.

**[:SOURce]:W3GPP:MSTation<i>:PRACH:PREPetition 1 to 10**

The command sets the number of repetitions of the preamble.

Example: `:SOUR:W3GP:MST3:PRAC:PREP 3`

\*RST value is 1

**[:SOURce]:W3GPP:MSTation<i>:PRACH:PPOWER -60 to 0 dB**

The command sets the power of the preamble.

Example: `:SOUR:W3GP:MST3:PRAC:PPOW -3.0`

\*RST value is 0.0

**[:SOURce]:W3GPP:MSTation<i>:PRACH:DPOWER -60 to 0 dB**

The command sets the power of the data part.

Example: `:SOUR:W3GP:MST3:PRAC:DPOW -12.1`

\*RST value is 0.0

**[[:SOURCE]:W3GPP:MSTation<i>:PRACH:CPOWer -60 to 0 dB**

The command sets the power of the control part.

Example: :SOUR:W3GP:MST3:PRAC:CPOW -20 \*RST value is 0.0

**[[:SOURCE]:W3GPP:MSTation<i>:PRACH:MLENght 1 | 2**

The command sets the length of the message parts.

Example: :SOUR:W3GP:MST3:PRAC:MLEN 2 \*RST value is 1

**[[:SOURCE]:W3GPP:MSTation<i>:PRACH:SIGNature 0 to 15**

The command sets the signature.

Example: :SOUR:W3GP:MST3:PRAC:SIGN 3 \*RST value is 0

**[[:SOURCE]:W3GPP:MSTation<i>:PRACH:ASLot 0 to 14**

The command offsets the start time of PRACH. The time expressed in timeslots is obtained by doubling the number of ASLot.

Example: :SOUR:W3GP:MST3:PRAC:ASL 3 \*RST value is 0

**[[:SOURCE]:W3GPP:MSTation<i>:PRACH:SRATe D15K | D30K | D60K | D120K**

The command sets the symbol rate.

Example: :SOUR:W3GP:MST3:PRAC:SRAT D120K \*RST value is D30K

**[[:SOURCE]:W3GPP:MSTation<i>:PRACH:DATA PN9 | PN11 | PN15 | PN16 | ZERO | ONE | PATTern**

The command sets the data source.

PNx pseudo random sequence of length x

ZERO all bits set to 0

ONE all bits set to 1

PATTern bit pattern selected with the following command

Example: :SOUR:W3GP:MST3:PRAC:DATA ZERO \*RST value is PN15

**[[:SOURCE]:W3GPP:MSTation<i>:PRACH:PATTern #B0 to B111..1, 1 to 24**

This command selects the bit pattern. It is only used if :W3GP:MST:PRAC:DATA PATT is set. The first parameter sets the bit pattern (optionally Hex, Oct or Bin syntax), the second one indicates the number of bits to be used.

Example: :SOUR:W3GP:MST3:PRAC:PATT #H3F, 8 \*RST value is #H0, 1

**[[:SOURCE]:W3GPP:MSTation<i>:PRACH:TFCI 0 to 1023**

The command sets the value for the TFCI (transport format combination indicator) field.

Example: :SOUR:W3GP:MST3:PRAC:TFCI 63 \*RST value is 0

**[[:SOURCE]:W3GPP:MSTation<i>:PCPCh...**

Commands for setting the physical common packet channel are under this node. The commands are only relevant under :W3GP:MST:MODE PCPC.

**[[:SOURCE]:W3GPP:MSTation<i>:PCPCh:PREPetition 0 to 10**

The command sets the number of repetitions of the preamble.

Example: :SOUR:W3GP:MST3:PCPC 4 \*RST value is 1

**[[:SOURce]:W3GPp:MSTation<i>:PCPCh:PPOWer -60 to 0 dB**

The command sets the power of the preamble part.

Example: `:SOUR:W3GP:MST3:PCPC:PPOW -3.0` \*RST value is 0.0

**[[:SOURce]:W3GPp:MSTation<i>:PCPCh:PPOWer:STEP 0 to 10 dB**

The command sets the step width for the power of the preamble part by which it is increased from repetition to repetition.

Example: `:SOUR:W3GP:MST3:PCPC:PPOW:STEP 3.0` \*RST value is 0.0

**[[:SOURce]:W3GPp:MSTation<i>:PCPCh:DPOWer -60 to 0 dB**

The command sets the power of the data part.

Example: `:SOUR:W3GP:MST3:PCPC:DPOW -10` \*RST value is 0.0

**[[:SOURce]:W3GPp:MSTation<i>:PCPCh:CPOWer -60 to 0 dB**

The command sets the power of the control part.

Example: `:SOUR:W3GP:MST3:PCPC:CPOW -12.3` \*RST value is 0.0

**[[:SOURce]:W3GPp:MSTation<i>:PCPCh:MLENght 0 to 10**

The command sets the length of the message part in number of frames.

Example: `:SOUR:W3GP:MST3:PCPC:MLEN 2` \*RST value is 1

**[[:SOURce]:W3GPp:MSTation<i>:PCPCh:PLENght S0 | S8**

The command sets the length of the power control preamble.

Example: `:SOUR:W3GP:MST3:PCPC:PLEN S0` \*RST value is S8

**[[:SOURce]:W3GPp:MSTation<i>:PCPCh:SIGNature 0 to 15**

The command sets the signature.

Example: `:SOUR:W3GP:MST3:PCPC:SIGN 4` \*RST value is 0

**[[:SOURce]:W3GPp:MSTation<i>:PCPCh:ASLot 0 to 14**

The command offsets the start time of PCPCH. The time expressed in timeslots is obtained by two times the number of ASLot.

Example: `:SOUR:W3GP:MST3:PCPC:ASL 5` \*RST value is 0

**[[:SOURce]:W3GPp:MSTation<i>:PCPCh:FBI:MODE OFF | D1B | D2B**

The command sets the number of bits (1 or 2) for the feedback information. The field is not used with OFF.

Example: `:SOUR:W3GP:MST3:PCPC:FBI:MODE D1B` \*RST value is OFF

**[[:SOURce]:W3GPp:MSTation<i>:PCPCh:FBI:DATA ZERO | ONE | PATTern**

The command selects the data source for the FBI field.

ZERO 0 data are continuously generated.

ONE 1 data are continuously generated.

PATT The bit pattern set with the following command is used.

Example: `:SOUR:W3GP:MST3:PCPC:FBI:DATA ONE` \*RST value is ZERO

**[[:SOURce]:W3GPP:MSTation<i>:PCPCh:FBI:PATtern #B0 to B111..1, 1 to 24**

This command sets the bit pattern. It is only used if `:W3GP:MST:PCPC:FBI:DATA PATT` is set. The first parameter sets the bit pattern (optionally Hex, Oct or Bin syntax), the second one indicates the number of bits to be used.

Example: `:SOUR:W3GP:MST3:PCPC:FBI:PATT #H3F, 8` \*RST value is #H0, 1

**[[:SOURce]:W3GPP:MSTation<i>:PCPCh:SRATe D15K | D30K | D60K | D120K | D240K | D480K | D960K**

The command sets the symbol rate. The selection depends on the channel type.

Example: `:SOUR:W3GP:MST3:PCPC:SRAT D15K` \*RST value is D30K

**[[:SOURce]:W3GPP:MSTation<i>:PCPCh:DATA PN9 | PN11 | PN15 | PN16 | ZERO | ONE | PATtern**

The command sets the data source.

PNx Pseudo random sequence of length x

ZERO All bits are set to 0

ONE all bits are set to 1

PATtern bit pattern selected with the following command

Example: `:SOUR:W3GP:MST3:PCPC:DATA PN11` \*RST value is PN15

**[[:SOURce]:W3GPP:MSTation<i>:PCPCh:PATtern #B0 to B111..1, 1 to 24**

The command sets the bit pattern. It is only used if `:W3GP:MST:PCPC:DATA PATT` is set. The first parameter sets the bit pattern (optionally Hex, Oct or Bin syntax), the second one indicates the number of bits to be used.

Example: `:SOUR:W3GP:MST3:PCPC:PATT #H3F, 8` \*RST value is #H0, 1

**[[:SOURce]:W3GPP:MSTation<i>:PCPCh:TFCI 0 to 1023**

The command sets the value for the TFCI (transport format combination indicator) field.

Example: `:SOUR:W3GP:MST3:PCPC:TFCI 63` \*RST value is 0

**[[:SOURce]:W3GPP:MSTation<i>:DPCCh...**

The commands for setting the standard operating mode with active control channel are under this node. The commands are only relevant under `:W3GP:MST:MODE DPCD`.

**[[:SOURce]:W3GPP:MSTation<i>:DPCCh:POWer -60 to 0 dB**

The command sets the power.

Example: `:SOUR:W3GP:MST3:DPCC:POW -10.0` \*RST value is 0.0

**[[:SOURce]:W3GPP:MSTation<i>:DPCCh:TOFFset?**

The command queries the time offset in multiples of 256 chips.

Example: `:SOUR:W3GP:MST3:DPCC:TOFF?`

**[[:SOURce]:W3GPP:MSTation<i>:DPCCh:TFCI 0 to 1023**

The command sets the value for the TFCI (transport format combination indicator) field.

Example: `:SOUR:W3GP:MST3:DPCC:TFCI 63` \*RST value is 0

**[[:SOURce]:W3GPP:MSTation<i>:DPCCh:TFCI:STATe ON | OFF**

The command activates the TFCI field (ON) or deactivates it (OFF).

Example: :SOUR:W3GP:MST3:DPCC:TFCI:STAT ON \*RST value is OFF

**[[:SOURce]:W3GPP:MSTation<i>:DPCCh:FBI:MODE OFF | D1B | D2B**

The command sets the number of bits (1 or 2) for the feedback information. The field is not used with OFF.

Example: :SOUR:W3GP:MST3:DPCC:FBI:MODE D1B \*RST value is OFF

**[[:SOURce]:W3GPP:MSTation<i>:DPCCh:FBI:DATA ZERO | ONE | PATTern**

The command selects the data source for the FBI field.

ZERO all bits are set to 0

ONE all bits are set to 1

PATTern bit pattern selected with the following command

Example: :SOUR:W3GP:MST3:DPCC:FBI:DATA PATT \*RST value is ZERO

**[[:SOURce]:W3GPP:MSTation<i>:DPCCh:FBI:PATTern #B0 to B111..1, 1 to 24**

The command sets the bit pattern for the FBI field. It is only used if :W3GP:MST:DPCC:FBI:DATA PATT is set. The first parameter sets the bit pattern (optionally Hex, Oct or Bin syntax), the second one indicates the number of bits to be used.

Example: :SOUR:W3GP:MST3:DPCC:FBI:PATT #H3F, 8 \*RST value is #H0, 1

**[[:SOURce]:W3GPP:MSTation<i>:DPCCh:TPC:MISuse ON | OFF**

The command sets the TPC mode. With ON the TPC pattern is misused for controlling the transmit power.

Example: :SOUR:W3GP:MST3:DPCC:TPC:MIS ON \*RST value is OFF

**[[:SOURce]:W3GPP:MSTation<i>:DPCCh:TPC:PSTep -10 to 10 dB**

The command sets the step width for controlling the transmit power. The command is only used under W3GP:MST:DPCC:TPC:MISuse ON.

Example: :SOUR:W3GP:MST3:DPCC:TPC:PST 1.5 \*RST value is 0.0

**[[:SOURce]:W3GPP:MSTation<i>:ENHanced...**

The commands for setting the enhanced functions for the 3GPP W-CDMA standard are under this node. These commands are only available if option SMIQB48 is installed. For further information see manual on remote-control commands of this option.

**[[:SOURce]:W3GPP:MSTation<i>:ADDitional...**

The commands for simulating up to 50 other mobile stations are under this node. These commands are only available if option SMIQB48 is installed. For further information see remote-control commands of this option.

**[[:SOURce]:W3GPP:MSTation<i>:DPDCh(<j>)...**

The commands for setting the standard operating mode with up to 6 data channels are under this node. <j> selects one of 6 data channels. The commands are only relevant under :W3GP:MST:MODE DPDC.

**[[:SOURce]:W3GPP:MSTation<i>:DPDCh:ORATe** D15K | D30K | D60K | D120K | D240K | D480K | D960K | X2 | X3 | X4 | X5 | X6

The command sets the overall symbol rate. It determines the structure of the channel table, the symbol rate of channels and the channelization codes.

Example: `:SOUR:W3GP:MST3:DPDC:ORAT D240K` \*RST value is D30K

**[[:SOURce]:W3GPP:MSTation<i>:DPDCh:POWer** 0 to 15

The command determines the power of each channel.

Example: `:SOUR:W3GP:MST3:DPDC:POW -3.0` \*RST value is 0.0

**[[:SOURce]:W3GPP:MSTation<i>:DPDCh<j>:SRATe?=>** D15K | D30K | D60K | D120K | D240K | D480K | D960K

The command queries the symbol rate of the channels.

Example: `:SOUR:W3GP:MST3:DPDC3:SRAT?`

**[[:SOURce]:W3GPP:MSTation<i>:DPDCh<j>:TYPE?**

The command queries the type of channels.

Example: `:SOUR:W3GP:MST3:DPDC3:TYPE?`

**[[:SOURce]:W3GPP:MSTation<i>:DPDCh<j>:CCODE?**

The command queries the channelization code of the channels.

Example: `:SOUR:W3GP:MST3:DPDC3:CCOD?`

**[[:SOURce]:W3GPP:MSTation<i>:DPDCh<j>:DATA** PN9 | PN11 | PN15 | PN16 | ZERO | ONE | PATTern

The command sets the data source.

PNx pseudo random sequence of length x

ZERO all bits are set to 0

ONE all bits are set to 1

PATTern bit pattern selected with the following command

Example: `:SOUR:W3GP:MST3:DPDC3:DATA PN9` \*RST value is PN15

**[[:SOURce]:W3GPP:MSTation<i>:DPDCh<j>:PATTern** #B0 to B111..1, 1 to 24

This command sets the bit pattern. It is only used if `:W3GP:MST:DPDC:DATA PATT` is set. The first parameter sets the bit pattern (optionally Hex, Oct or Bin syntax), the second one indicates the number of bits to be used.

Example: `:SOUR:W3GP:MST3:DPDC3:PATT #H3F, 8` \*RST value is #H0, 1



### 3.5.14.27 SOURce:W3GPP:ENHanced/OCNS/ADDITIONal Subsystems

The commands for generating an extended 3 GPP W-CDMA signal are contained in these subsystems. They are only available with option SMIQB48 installed.

**Note:** #H0 to #HF are numerals which are entered in alphanumeric hex syntax manually. #B0|1 are numerals of binary syntax. SCPI (and IEEE 488.2) allow the entry of non-decimal numbers in all forms  
 #H|h <0 to 9, A|a to F|f>, #Q|q <0 to 7> and #B|b <0|1>.  
 However, the format of manual operation is always used for the output generated by a query.

Command	Parameter	Default Unit	Remark
[[:SOURce]:W3GPP			
:BSTation			Base station
:ENHanced			
:STATe	ON   OFF		
:PCCPch			
[:STATe]	ON   OFF		
:CCODing			
:STATe	ON   OFF		
:TYPE	M12K2   M64K   M144K   M384K   AMR		
:INTerleaver[1]	ON   OFF		
:INTerleaver2	ON   OFF		
:EPOWer			External power
:STATe	ON   OFF		
:STEP	0.0 to 6.0	dB	
:RANGe			
:UP	0.0 to 30.0	dB	
:DOWN	0.0 to 30.0	dB	
:SLENgth	1 to (800)	(Frames)	
:FREE?	=> <i>	(Frames)	Query only
:PCCPch			
:SLENgth?	=>1	(Frames)	Query only
:SRATe	D7K5   D15K   D30K   D60K   D120K   D240K   D480K   D960K	(S/s)	
:TOFFset	0 to 149		Timing offset
:PLENgth	BIT2   BIT 4   BIT8   BIT 16		
:DERRor			Insert bit errors in data
:BIT			
:STATe	ON   OFF		
:RATE	1E-1 to 1E-7		
:DPCH?	=> <n>		Query only
:DTCH?	=> <n>		Query only
:DCCH?	=> <n>		Query only
:BLOCK			
:STATe	ON   OFF		
:RATE	1E-1 to 1E-7		
:DTCH?	=> <n>		Query only
:DCCH?	=> <n>		Query only
:CHANnel<i>	where i = 4   11   12   13   14		4 only with PCCP ON
:STATe	ON   OFF		
:CHNCode	0 to (511)		Channelization code
:POWer			
:STARt	-60.0 to 0	dB	

Command	Parameter	Default Unit	Remark
[[:SOURCE]:W3GPP			
:BSTation			Base station
:ENHanced			
:CONTRol	OFF   UP   DOWN		
:DATA	PN9   PN11   PN15   PN16   ZERO   ONE   PATTErn   DLISt		
:PATTErn	#B0 to B111..1, 1 to 24		
:DSELEct	'name'		
:CHANnel<i>	where i = 4   11   12   13   14		4 only with PCCP ON
:DTCH	PN9   PN11   PN15   PN16   ZERO   ONE   PATTErn   DLISt		
:PATTErn	#B0 to B111..1, 1 to 24		
:DSELEct	'name'		
:DCCH	PN9   PN11   PN15   PN16   ZERO   ONE   PATTErn   DLISt		
:PATTErn	#B0 to B111..1, 1 to 24		
:DSELEct	'name'		
:PLENght	BIT2   BIT4   BIT8   BIT16		
:TPC	ZERO   ONE   PATTErn   DLISt		
:PATTErn	#B0 to B111..1, 1 to 24		
:DSELEct	'name'		
:MCODE	ON   OFF		
:OCNS			
:COUNT	1 to (508)		
:SRATE	D7K5   D15K   D30K   D60K   D120K   D240K   D480K   D960K	(S/s)	
:CRESt	MINimum   AVERAge   WORSt		
:POWEr	-60.0 to 0.0	dB	
:PCCPch			
:STATE	ON   OFF		
:POWEr	-60.0 to 0.0	dB	
:EPOWEr	-60.0 to 30.0	dB	
:EXECute	(without)		
:MSTation			Mobile station
:ENHanced			
:STATE	ON   OFF		
:CCODing			Channel coding
:STATE	ON   OFF		
:TYPE	M12K2   M64K   M144K   M384K   AMR		
:INTerleaver[1]	ON   OFF		
:INTerleaver2	ON   OFF		
:EPOWEr			External power
:STATE	ON   OFF		
:START			
:DPCCh	-60.0..0.0	dB	
:DPDCh	-60.0..0.0	dB	
:STEP	0.0 to 6.0	dB	
:RANGE			
:UP	0.0 to 30.0	dB	
:DOWN	0.0 to 30.0	dB	
:SLENGth	1 to (800)	(Frames)	
:FREE?	=> <i>	(Frames)	Query only
:ORATE	D15K   D30K   D60K   D120K   D240K   D480K   D960K   X2   X3   X4   X5   X6	(S/s)	

Command	Parameter	Default Unit	Remark
[:SOURce]:W3GPP			
:MSTation			Mobile station
ENHanced			
:DPCCh			
:STATe	ON   OFF		
:POWer			
:DPCCh	-60.0 to 0.0	dB	
:DPDCh	-60.0 to 0.0	dB	
:DERRor			Insert bit errors in data
:STATe	ON   OFF		
:RATE	1E-1 to 1E-7		
:BIT			
:DPDCh?	⇒ <n>		Query only
:DTCH?	⇒ <n>		Query only
:DCCH?	⇒ <n>		Query only
:BLOCK			
:STATe	ON   OFF		
:RATE	1E-1 to 1E-7		
:DTCH?	⇒ <n>		Query only
:DCCH?	⇒ <n>		Query only
:CHANnel<i>	where i = 0   [1]   2   3   4   5   6		
:SRATe?	⇒ D15K   D30K   D60K   D120K   D240K   D480K   D960K	(S/s)	
:CHNCode?			Channelization code Query only
:DATA	PN9   PN11   PN15   PN16   ZERO   ONE   PATTErn   DLISt		
:PATTern	#B0 to B111..1, 1 to 24		
:DSElect	'name'		
:DTCH	PN9   PN11   PN15   PN16   ZERO   ONE   PATTErn   DLISt		
:PATTern	#B0 to B111..1, 1 to 24		
:DSElect	'name'		
:DCCH	PN9   PN11   PN15   PN16   ZERO   ONE   PATTErn   DLISt		
:PATTern	#B0 to B111..1, 1 to 24		
:DSElect	'name'		
:ADDITIONal			
:STATe	ON   OFF		
:COUNT	1 to 50		
:SCODE			
:STEP	#H1 to #H100		
:POWer			
:OFFSet	-20.0 to 20.0	dB	

**Note:** The calculation of the W-CDMA sequences is rather time-consuming and should be re-started for any new setting. The W-CDMA modulation is therefore switched off for each command (:SOUR:W3GP:STAT OFF performed automatically). The user can now perform several settings without any delay and has to switch on again the W-CDMA modulation (with :SOUR:W3GP:STAT ON). The calculations are performed and the previous settings are effective after this command is given.

**[:SOURce]:W3GPP:BSTation:ENHanced...**

The commands for generating an enhanced 3 GPP W-CDMA signal for the base stations are under this node. They are only available with option SMIQB48 installed. They are only effective if the link direction is set to FORW (`SOUR:W3GP:LINK FORW`) and are only valid for base station 1 (suffix 2, 3 or 4 after BSTation – as in the higher W-CDMA commands – is not permitted).

**[:SOURce]:W3GPP:BSTation:ENHanced:STATe ON | OFF**

The command activates (up to 4) enhanced channels (ON) or deactivates them (OFF).

Example: `:SOUR:W3GP:BST:ENH:STAT ON` \*RST value is OFF

**[:SOURce]:W3GPP:BSTation:ENHanced:CCODing...**

The commands for the channel coding of all enhanced channels are under this node.

**[:SOURce]:W3GPP:BSTation:ENHanced:CCODing:STATe ON | OFF**

The command activates or deactivates the channel coding of all enhanced channels.

Example: `:SOUR:W3GP:BST:ENH:CCOD:STAT ON` \*RST value is OFF

**[:SOURce]:W3GPP:BSTation:ENHanced:PCCPch[:STATe]ON | OFF**

The command activates (ON) or deactivates (OFF) the Enhanced P-CCPCH/BCH\_Channel including SFN. This enables channel 4 to be set. The only other channel that can be set, however, is channel 11 (see `:SOUR:W3GP:BST:ENH:CHAN<i>. . .`).

Example: `:SOUR:W3GP:BST:ENH:PCCP ON` \*RST value is OFF

**[:SOURce]:W3GPP:BSTation:ENHanced:CCODing:TYPE M12K2 | M64K | M144K | M384K | AMR**

The command sets one of four measurement channel coding types that are predefined by 3GPP and differ in the data bit rate to be processed. Also the AMR-CODER schematic can be switched on.

Example: `:SOUR:W3GP:BST:ENH:CCOD:TYPE M144K` \*RST value is M12K2

**[:SOURce]:W3GPP:BSTation:ENHanced:CCODing:INTERleaver[1] ON | OFF**

The command switches the channel coding interleaver stage 1 on or off. Suffix 1 can be given as an option

Example: `:SOUR:W3GP:BST:ENH:CCOD:INT OFF` \*RST value is ON

**[:SOURce]:W3GPP:BSTation:ENHanced:CCODing:INTERleaver2 ON | OFF**

The command switches the channel coding interleaver stage 2 on or off.

Example: `:SOUR:W3GP:BST:ENH:CCOD:INT2 OFF` \*RST value is ON

**[:SOURce]:W3GPP:BSTation:ENHanced:EPOWER:STATe ON | OFF**

The command activates the external power control mechanism of the enhanced channels on or off.

Example: `:SOUR:W3GP:BST:ENH:EPOW:STAT ON` \*RST value is OFF

**[:SOURce]:W3GPP:BSTation:ENHanced:EPOWER:STEP 0 to 6.0 dB**

The command sets the step width of the channel power for the external power control mechanism.

Example: `:SOUR:W3GP:BST:ENH:EPOW:STEP 3.1` \*RST value is 1.0

- [[:SOURce]:W3GPP:BSTation:ENHanced:EPOWer:RANGe:UP 0 to 30.0 dB**  
The command sets the dynamic range for ranging up the channel power.  
Example: :SOUR:W3GP:BST:ENH:EPOW:RANG:UP 6.0 \*RST value is 10.0
- [[:SOURce]:W3GPP:BSTation:ENHanced:EPOWer:RANGe:DOWN 0 to 30.0 dB**  
The command sets the dynamic range for ranging down the channel power.  
Example: :SOUR:W3GP:BST:ENH:EPOW:RANG:DOWN 3.0 \*RST value is 10.0
- [[:SOURce]:W3GPP:BSTation:ENHanced:SLENGth 1 to (800)**  
The command sets the radio frame sequence length. The maximum size depends on the available memory capacity.  
Example: :SOUR:W3GP:BST:ENH:SLEN 23 \*RST value is 1
- [[:SOURce]:W3GPP:BSTation:ENHanced:SLENGth:FREE?**  
The command queries the free memory available for the radio frame sequence.  
Example: :SOUR:W3GP:BST:ENH:SLEN:FREE?
- [[:SOURce]:W3GPP:BSTation:ENHanced:PCCPch:SLENGth?**  
The command queries the frame sequence length of P-CCPCH/BCH.  
Example: :SOUR:W3GP:BST:ENH:PCCP:SLEN?
- [[:SOURce]:W3GPP:BSTation:ENHanced:SRATE D7K5 | D15K | D30K | D60K | D120K | D240K | D480K | D960K**  
The command sets the symbol rate of the enhanced channels.  
Example: :SOUR:W3GP:BST:ENH:SRATE D120K \*RST value is D15K
- [[:SOURce]:W3GPP:BSTation:ENHanced:TOFFset 0 to 149**  
The command sets the timing offset (in \*256 chips) by which the corresponding channel is sent.  
Example: :SOUR:W3GP:BST:ENH:TOFF 32 \*RST value is 0
- [[:SOURce]:W3GPP:BSTation:ENHanced:PLENGth BIT2 | BIT4 | BIT8 | BIT16**  
The command sets the pilot field size for the corresponding channel.  
Example: :SOUR:W3GP:BST:ENH:PLEN 8 \*RST value is 4
- [[:SOURce]:W3GPP:BSTation:ENHanced:DERRor:BIT:STATe ON | OFF**  
The command switches the insertion of bit errors into the data fields on or off.  
Example: :SOUR:W3GP:BST:ENH:DERR:BIT:STAT ON \*RST value is OFF
- [[:SOURce]:W3GPP:BSTation:ENHanced:DERRor:BIT:RATE 1E-1 to 1E-7**  
The command sets the bit error rate desired by the user.  
Example: :SOUR:W3GP:BST:ENH:DERR:BIT:RATE 1E-6 \*RST value is 1E-3
- [[:SOURce]:W3GPP:BSTation:ENHanced:DERRor:BIT:DPCH?**  
The command queries the resulting bit error rate of DPCH since the rate desired by the user cannot be precisely calculated.  
Example: :SOUR:W3GP:BST:ENH:DERR:BIT:DPCH?

**[[:SOURce]:W3GPP:BSTation:ENHanced:DERRor:BIT:DTCH?**

The command queries the resulting bit error rate of the DTCHs since the rate desired by the user cannot be precisely calculated.

Example: `:SOUR:W3GP:BST:ENH:DERR:BIT:DTCH?`

**[[:SOURce]:W3GPP:BSTation:ENHanced:DERRor:BIT:DCCH?**

The command queries the resulting bit error rate of the DCCHs since the rate desired by the user cannot be precisely calculated.

Example: `:SOUR:W3GP:BST:ENH:DERR:BIT:DCCH?`

**[[:SOURce]:W3GPP:BSTation:ENHanced:DERRor:BLOCK:STATe ON | OFF**

The command switches the insertion of bit errors into the CRC fields of the channel-coding stage on or off.

Example: `:SOUR:W3GP:BST:ENH:DERR:BLOCK:STAT ON` \*RST value is OFF

**[[:SOURce]:W3GPP:BSTation:ENHanced:DERRor:BLOCK:RATE 1E-1 to 1E-7**

The command sets the bit error rate desired by the user into the CRC fields of the channel-coding stage.

Example: `:SOUR:W3GP:BST:ENH:DERR:BLOCK:RATE 1E-6` \*RST value is 1E-3

**[[:SOURce]:W3GPP:BSTation:ENHanced:DERRor:BLOCK:DTCH?**

The command queries the resulting bit error rate of the DTCHs since the rate desired by the user cannot be precisely calculated.

Example: `:SOUR:W3GP:BST:ENH:DERR:BLOCK:DTCH?`

**[[:SOURce]:W3GPP:BSTation:ENHanced:DERRor:BLOCK:DCCH?**

The command queries the resulting bit error rate of the DCCHs since the rate desired by the user cannot be precisely calculated.

Example: `:SOUR:W3GP:BST:ENH:DERR:BLOCK:DCCH?`

**[[:SOURce]:W3GPP:BSTation:ENHanced:CHANnel<i>**

The commands that can separately be set for each channel are under this node. Channels 11 to 14 can be changed. Therefore, suffix *i* has 11, 12, 13 or 14 as valid values. With `:SOUR:W3GP:BST:ENH:PCCP ON` set, channel 4 can also be set. The only other channel that can be set, however, is channel 11.

**[[:SOURce]:W3GPP:BSTation:ENHanced:CHANnel<i>:STATe ON | OFF**

The command switches the corresponding channel on or off.

Example: `:SOUR:W3GP:BST:ENH:CHAN:STAT ON` \*RST value is OFF

**[[:SOURce]:W3GPP:BSTation:ENHanced:CHANnel<i>:CHNCode 0 to (511)**

The command sets the channelization code for the corresponding channel.

Example: `:SOUR:W3GP:BST:ENH:CHAN:CHNC 5` \*RST value is 0

**[[:SOURce]:W3GPP:BSTation:ENHanced:CHANnel<i>:POWER:STARt -60.0 to 0 dB**

The command sets the channel power for the external power control mechanism for the corresponding channel.

Example: `:SOUR:W3GP:BST:ENH:CHAN13:POW:STAR -20` \*RST value is 0

**[:SOURce]:W3GPP:BSTation:ENHanced:CHANnel<i>:POWER:CONTrol OFF | UP | DOWN**

The command sets the direction of the STEP for the external power control mechanism for the corresponding channel.

Example: `:SOUR:W3GP:BST:ENH:CHAN11:POW:CONT UP` \*RST value is OFF

**[:SOURce]:W3GPP:BSTation:ENHanced:CHANnel<i>:DATA PN9 | PN11 | PN15 | PN16 | ZERO | ONE | PATTern | DLISt**

The command selects the data source for the data fields of the corresponding channel.

PNx Pseudo random sequence of length x

ZERO All bits set to 0

ONE All bits set to 1

PATTern The bit pattern selected with `:W3GP:BST:ENH:CHAN12:DATA:PATT`

DLISt The data list selected with `:W3GP:BST:ENH:CHAN12:DATA:DSEL`

Example: `:SOUR:W3GP:BST:ENH:CHAN12:DATA PN11` \*RST value is PN15

**[:SOURce]:W3GPP:BSTation:ENHanced:CHANnel<i>:DATA:PATTern #B0 to #B111..1, 1 to 24**

The command defines a bit pattern for the data of the corresponding channel. The first parameter sets the bit pattern (optionally Hex, Oct or Bin syntax), the second one indicates the number of bits to be used.

Example: `:SOUR:W3GP:BST:ENH:CHAN12:DATA:PATT #H3F, 8` \*RST value is #H0, 1

**[:SOURce]:W3GPP:BSTation:ENHanced:CHANnel<i>:DATA:DSElect 'name'**

The command defines a data list for the data of the corresponding channel.

Example: `:SOUR:W3GP:BST:ENH:CHAN12:DATA:DSEL 'test'` without \*RST value

**[:SOURce]:W3GPP:BSTation:ENHanced:CHANnel<i>:DTCH PN9 | PN11 | PN15 | PN16 | ZERO | ONE | PATTern | DLISt**

The command selects the data source for the DTCH channel.

PNx pseudo random sequence of length x

ZERO all bits set to 0

ONE all bits set to 1

PATTern bit pattern selected with `:W3GP:BST:ENH:CHAN12:DTCH:PATT`

DLISt data list selected with `:W3GP:BST:ENH:CHAN12:DTCH:DSEL`

Example: `:SOUR:W3GP:BST:ENH:CHAN12:DTCH PN11` \*RST value is PN15

**[:SOURce]:W3GPP:BSTation:ENHanced:CHANnel<i>:DTCH:PATTern #B0 to #B111..1, 1 to 24**

The command defines a bit pattern for the data of the DTCH channel. The first parameter sets the bit pattern (optionally in hex, oct or bin notation), the second one indicates the number of bits to be used.

Example: `:SOUR:W3GP:BST:ENH:CHAN12:DTCH:PATT #H3F, 8` \*RST value is #H0, 1

**[:SOURce]:W3GPP:BSTation:ENHanced:CHANnel<i>:DTCH:DSElect 'name'**

The command selects a data list for the data of the DTCH channel.

Example: `:SOUR:W3GP:BST:ENH:CHAN12:DTCH:DSEL 'test'` without \*RST value

**[:SOURce]:W3GPP:BSTation:ENHanced:CHANnel<i>:DCCH PN9 | PN11 | PN15 | PN16 | ZERO | ONE | PATTern | DLISt**

The command selects the data source for the DCCH channel.

PNx pseudo random sequence of length x

ZERO all bits set to 0  
 ONE all bits set to 1  
 PATTERN bit pattern selected with :W3GP:BST:ENH:CHAN12:DCCH:PATT  
 DLIST data list selected with :W3GP:BST:ENH:CHAN12:DCCH:DSEL  
 Example: :SOUR:W3GP:BST:ENH:CHAN12:DCCH PN11 \*RST value is PN15

**[[:SOURCE]:W3GPP:BSTation:ENHanced:CHANnel<i>:DCCH:PATTERN #B0 to #B111..1, 1 to 24**

The command defines a bit pattern for the data of the DCCH channel. The first parameter sets the bit pattern (optionally in hex, oct or bin notation), the second one indicates the number of bits to be used.

Example: :SOUR:W3GP:BST:ENH:CHAN12:DCCH:PATT #H3F, 8 \*RST value is #H0, 1

**[[:SOURCE]:W3GPP:BSTation:ENHanced:CHANnel<i>:DCCH:DSElect 'name'**

The command selects a data list for the data of the DCCH channel.

Example: :SOUR:W3GP:BST:ENH:CHAN12:DCCH:DSEL 'test' without \*RST value

**[[:SOURCE]:W3GPP:BSTation:ENHanced:CHANnel<i>:TPC ZERO | ONE | PATTERN | DLIST**

The command selects the data source for the TPC field of the corresponding channel.

ZERO All bits set to 0

ONE All bits set to 1

PATTERN The bit pattern selected with :W3GP:BST:ENH:CHAN12:TPC:PATT

DLIST The data list selected with :W3GP:BST:ENH:CHAN12:TPC:DSEL

The command selects the data source for the TPC field of the corresponding channel.

Example: :SOUR:W3GP:BST:ENH:CHAN12:TPC ZERO \*RST value is PATT

**[[:SOURCE]:W3GPP:BSTation:ENHanced:CHANnel<i>:TPC:PATTERN #B0 to #B111..1, 1 to 24**

The command defines a bit pattern for the TPC field of the corresponding channel. The first parameter sets the bit pattern (optionally Hex, Oct or Bin syntax), the second one indicates the number of bits to be used.

Example: :SOUR:W3GP:BST:ENH:CHAN12:TPC:PATT #H3F, 8 \*RST value is #H0, 1

**[[:SOURCE]:W3GPP:BSTation:ENHanced:CHANnel<i>:TPC:DSElect 'name'**

The command selects a data list for the TPC field of the corresponding channel.

Example: :SOUR:W3GP:BST:ENH:CHAN12:TPC:DSEL 'test' without \*RST value

**[[:SOURCE]:W3GPP:BSTation:ENHanced:CHANnel<i>:MCODe ON | OFF**

The command switches the multicode for the corresponding channel on or off.

Example: :SOUR:W3GP:BST:ENH:CHAN12:MCOD ON \*RST value is OFF

**[[:SOURCE]:W3GPP:BSTation:OCNS...**

The commands for generating the OCNS superimposed impairments for the enhanced 3 GPP W-CDMA channels are under this node. The commands are only available with option SMIQB48 installed. They are only effective if the link direction is set to FORW (SOURCE:W3GP:BST:ENH:LINK FORW) and are only valid for base station 1 (suffix 2, 3 or 4 after BSTation – as in the higher W-CDMA commands – is not permitted). All OCNS settings become effective only after execution of :W3GP:BST:OCNS:EXEC.

**[[:SOURCE]:W3GPP:BSTation:OCNS:STATe ON | OFF**

The command activates the OCNS channels (ON) or deactivates them (OFF).

Example: :SOUR:W3GP:BST:OCNS:STAT ON \*RST value is OFF



**[:SOURce]:W3GPP:BSTation:OCNS:COUNT 1 to (508)**

The command sets the number of OCNS channels that are added in addition to the enhanced channels. The maximum number depends on the OCNS symbol rate.

Example: `:SOUR:W3GP:BST:OCNS:COUN 6` \*RST value is 10

**[:SOURce]:W3GPP:BSTation:OCNS:SRATe D7K5 | D15K | D30K | D60K | D120K | D240K | D480K | D960K**

The command sets the symbol rate of all OCNS channels.

Example: `:SOUR:W3GP:BST:OCNS:SRAT D120K` \*RST value is D30K

**[:SOURce]:W3GPP:BSTation:OCNS:CRESt MINimum | AVERAge | WORSt**

The command selects the type of optimization for the crest factor.

MINimum Minimum crest factor

AVERAge Average crest factor

WORSt Maximum crest factor

Example: `:SOUR:W3GP:BST:OCNS:CRESt WORS` \*RST value is MIN

**[:SOURce]:W3GPP:BSTation:OCNS:POWER -60.0 to 0 dB**

The command sets the power part of OCNS channels with reference to the total signal.

Example: `:SOUR:W3GP:BST:OCNS:POWER -6.0` \*RST value is -5.2

**[:SOURce]:W3GPP:BSTation:OCNS:PCCPch:STATe ON | OFF**

The command switches the P-CCPCH (for the OCNS channels) on or off.

Example: `:SOUR:W3GP:BST:OCNS:PCCP:STAT OFF` \*RST value is ON

**[:SOURce]:W3GPP:BSTation:OCNS:PCCPch:POWER -60.0 to 0 dB**

The command sets the power part of P-CCPCH with reference to the total signal.

Example: `:SOUR:W3GP:BST:OCNS:PCCP:POWER -9.0` \*RST value is -10.0

**[:SOURce]:W3GPP:BSTation:OCNS:EPOWER -60.0 to 0 dB**

The command sets the power part of the enhanced channels with reference to the total signal.

Example: `:SOUR:W3GP:BST:OCNS:EPOWER -20` \*RST value is 0

**[:SOURce]:W3GPP:BSTation:OCNS:EXECute**

The channel table for the OCNS superimposed impairments are filled with this command. All OCNS settings become valid. Moreover, the calculation of W-CDMA sequences has to be started with `:SOUR:W3GP:STAT ON` for the channel table to become effective.

Example: `:SOUR:W3GP:BST:OCNS:EXEC`

**[:SOURce]:W3GPP:MSTation:ENHanced...**

The commands for generating an enhanced 3 GPP W-CDMA signal for the mobile station are under this node. They are only available with option SMIQB48 installed. They are only effective if the link direction is set to REVerse (`:SOUR:W3GP:LINK REV`) and are only valid for mobile station 1 (suffix 2, 3 or 4 after MSTation – as in the higher W-CDMA commands – is not permitted).

**[:SOURce]:W3GPP:MSTation:ENHanced:STATe ON | OFF**

The command activates (up to 4) enhanced channels (ON) or deactivates them (OFF).

Example: `:SOUR:W3GP:MST:ENH:STAT ON` \*RST value is OFF

**[[:SOURce]:W3GPP:MSTation:ENHanced:CCODing**

The commands for the channel coding of all enhanced channels are under this node.

**[[:SOURce]:W3GPP:MSTation:ENHanced:CCODing:STATe ON | OFF**

The command activates or deactivates the channel coding of all enhanced channels.

Example: `:SOUR:W3GP:MST:ENH:CCOD:STAT ON` \*RST value is OFF

**[[:SOURce]:W3GPP:MSTation:ENHanced:CCODing:TYPE M12K2 | M64K | M144K | M384K | AMR**

The command sets one of four measurement channel coding types that are predefined by 3GPP and differ in the data bit rate to be processed. Also the AMR-CODER schematic can be switched on.

Example: `:SOUR:W3GP:MST:ENH:CCOD:TYPE M144K` \*RST value is M12K2

**[[:SOURce]:W3GPP:MSTation:ENHanced:CCODing:INTERleaver[1] ON | OFF**

The command switches the channel coding interleaver stage 1 on or off. Suffix 1 can be given as an option.

Example: `:SOUR:W3GP:MST:ENH:CCOD:INT OFF` \*RST value is ON

**[[:SOURce]:W3GPP:MSTation:ENHanced:CCODing:INTERleaver2 ON | OFF**

The command switches the channel coding interleaver stage 2 on or off.

Example: `:SOUR:W3GP:MST:ENH:CCOD:INT2 OFF` \*RST value is ON

**[[:SOURce]:W3GPP:MSTation:ENHanced:EPOWER:STATe ON | OFF**

The command activates the external power control mechanism of the enhanced channels on or off.

Example: `:SOUR:W3GP:MST:ENH:EPOW:STAT ON` \*RST value is OFF

**[[:SOURce]:W3GPP:MSTation:ENHanced:EPOWER:STEP 0 to 6.0 dB**

The command sets the step width of the channel power for the external power control mechanism.

Example: `:SOUR:W3GP:MST:ENH:EPOW:STEP 3.0` \*RST value is 1.0

**[[:SOURce]:W3GPP:MSTation:ENHanced:EPOWER:RANGe:UP 0 to 30.0 dB**

The command sets the dynamic range for ranging up the channel power.

Example: `:SOUR:W3GP:MST:ENH:EPOW:RANG:UP 12.0` \*RST value is 10

**[[:SOURce]:W3GPP:MSTation:ENHanced:EPOWER:RANGe:DOWN 0 to 30.0 dB**

The command sets the dynamic range for ranging down the channel power.

Example: `:SOUR:W3GP:MST:ENH:EPOW:RANG:DOWN 3.4` \*RST value is 10

**[[:SOURce]:W3GPP:MSTation:ENHanced:SLENgth 1 to (800)**

The command sets the radio frame sequence length. The maximum size depends on the available memory capacity.

Example: `:SOUR:W3GP:MST:ENH:SLEN 3` \*RST value is 1

**[[:SOURce]:W3GPP:MSTation:ENHanced:SLENgth:FREE?**

The command queries the free memory available for the radio frame sequence.

Example: `:SOUR:W3GP:MST:ENH:SLEN:FREE?`

**[:SOURce]:W3GPP:MSTation:ENHanced:ORATe** D15K | D30K | D60K | D120K | D240K | D480K | D960K | X2 | X3 | X4 | X5 | X6

The command sets the overall symbol rate of the enhanced channels.

Example: `:SOUR:W3GP:MST:ENH:ORAT D120K` \*RST value is D30K

**[:SOURce]:W3GPP:MSTation:ENHanced:DPCCh:STATe** ON | OFF

This command switches the calculation mode for the DPCCH.

Example: `:SOUR:W3GP:MST:ENH:DPCC:STAT OFF` \*RST value is ON

**[:SOURce]:W3GPP:MSTation:ENHanced:POWer:DPCCh** -60.0 to 0 dB

The command sets the channel start power of the DPCCH.

Example: `:SOUR:W3GP:MST:ENH:POW:DPCC -30` \*RST value is 0

**[:SOURce]:W3GPP:MSTation:ENHanced:POWer:DPDCh** -60.0 to 0 dB

The command sets the channel start power of DPDCH.

Example: `:SOUR:W3GP:MST:ENH:POW:DPDC -30` \*RST value is 0

**[:SOURce]:W3GPP:MSTation:ENHanced:DERRor:BIT:STATe** ON | OFF

The command switches the insertion of bit errors into the data fields on or off.

Example: `:SOUR:W3GP:MST:ENH:DERR:BIT:STAT ON` \*RST value is OFF

**[:SOURce]:W3GPP:MSTation:ENHanced:DERRor:BIT:RATE** 1E-1 to 1E-7

The command sets the bit error rate desired by the user.

Example: `:SOUR:W3GP:MST:ENH:DERR:BIT:RATE 1E-6` \*RST value is 1E-3

**[:SOURce]:W3GPP:MSTation:ENHanced:DERRor:BIT:DPDCh?**

The command queries the resulting bit error rate since the rate desired by the user cannot be precisely calculated.

Example: `:SOUR:W3GP:MST:ENH:DERR:BIT:DPDC?`

**[:SOURce]:W3GPP:MSTation:ENHanced:DERRor:BIT:DTCH?**

The command queries the resulting bit error rate of the DTCHs since the rate desired by the user cannot be precisely calculated.

Example: `:SOUR:W3GP:MST:ENH:DERR:BIT:DTCH?`

**[:SOURce]:W3GPP:MSTation:ENHanced:DERRor:BIT:DCCH?**

The command queries the resulting bit error rate of the DCCHs since the rate desired by the user cannot be precisely calculated.

Example: `:SOUR:W3GP:MST:ENH:DERR:BIT:DCCH?`

**[:SOURce]:W3GPP:MSTation:ENHanced:DERRor:BLOCK:STATe** ON | OFF

The command switches the insertion of bit errors into the CRC fields of the channel-coding stage on or off.

Example: `:SOUR:W3GP:MST:ENH:DERR:BLOCK:STAT ON` \*RST value is OFF

**[:SOURce]:W3GPP:MSTation:ENHanced:DERRor:BLOCK:RATE** 1E-1 to 1E-7

The command sets the bit error rate desired by the user into the CRC fields of the channel-coding stage.

Example: `:SOUR:W3GP:MST:ENH:DERR:BLOCK:RATE 1E-6` \*RST value is 1E-3

**[ :SOURCE ] : W3GPP : MSTation : ENHanced : DERRor : BLOCk : DTCH ?**

The command queries the resulting bit error rate of the DTCHs since the rate desired by the user cannot be precisely calculated.

Example: : SOUR : W3GP : MST : ENH : DERR : BLOCk : DTCH ?

**[ :SOURCE ] : W3GPP : MSTation : ENHanced : DERRor : BLOCk : DCCH ?**

The command queries the resulting bit error rate of the DCCHs since the rate desired by the user cannot be precisely calculated.

Example: : SOUR : W3GP : MST : ENH : DERR : BLOCk : DCCH ?

**[ :SOURCE ] : W3GPP : MSTation : ENHanced : CHANnel < i >**

The commands that can separately be set for each channel are under this node. Channels 1 to 6 (0=DPCCH; 1 to 6=DPDCH) can be changed which is why suffix i has 0 to 6 as valid values. Without suffix, channel 1 is set.

**[ :SOURCE ] : W3GPP : MSTation : ENHanced : CHANnel < i > : SRATE ?**

The command queries the resulting symbol rate.

Example: : SOUR : W3GP : MST : ENH : CHAN : SRAT ?

**[ :SOURCE ] : W3GPP : MSTation : ENHanced : CHANnel < i > : CHNCode ?**

The command queries the channelization code for the corresponding enhanced channel.

Example: : SOUR : W3GP : MST : ENH : CHAN : CHNC ?

**[ :SOURCE ] : W3GPP : MSTation : ENHanced : CHANnel < i > : DATA PN9 | PN11 | PN15 | PN16 | ZERO | ONE | PATTErn | DLISt**

The command selects the data source for the data fields of the corresponding channel.

PNx pseudo random sequence of length x

ZERO all bits set to 0

ONE all bits set to 1

PATTErn the bit pattern selected with : W3GP : MST : ENH : CHAN2 : DATA : PATT

DLIST the data list selected with : W3GP : MST : ENH : CHAN2 : DATA : DSEL

Example: : SOUR : W3GP : MST : ENH : CHAN : DATA PATT \*RST value is PN15

**[ :SOURCE ] : W3GPP : MSTation : ENHanced : CHANnel < i > : DATA : PATTErn #B0 to #B111..1, 1 to 24**

The command defines a bit pattern for the data of the corresponding channel. The first parameter sets the bit pattern (optionally Hex, Oct or Bin syntax), the second one indicates the number of bits to be used.

Example: : SOUR : W3GP : MST : ENH : CHAN2 : DATA : PATT #H3F, 8 \*RST value is #H0, 1

**[ :SOURCE ] : W3GPP : MSTation : ENHanced : CHANnel < i > : DATA : DSELEct 'name'**

The command defines a data list for the data of the corresponding channel.

Example: : SOUR : W3GP : MST : ENH : CHAN : DATA : DSEL 'test' without \*RST value

**[:SOURce]:W3GPP:MSTation:ENHanced:CHANnel<i>:DTCH** PN9 | PN11 | PN15 | PN16 | ZERO | ONE | PATTErn | DLISt

The command selects the data source for the DTCH channel.

PNx pseudo random sequence of length x

ZERO all bits set to 0

ONE all bits set to 1

PATTErn bit pattern selected with :W3GP:MST:ENH:CHAN2:DTCH:PATT

DLISt data list selected with :W3GP:MST:ENH:CHAN2:DTCH:DSEL

Example: :SOUR:W3GP:MST:ENH:CHAN2:DTCH PN11 \*RST value is PN15

**[:SOURce]:W3GPP:MSTation:ENHanced:CHANnel<i>:DTCH:PATTern** #B0 to #B111..1, 1 to 24

The command defines a bit pattern for the data of the DTCH channel. The first parameter sets the bit pattern (optionally in hex, oct or bin notation), the second one indicates the number of bits to be used.

Example: :SOUR:W3GP:MST:ENH:CHAN2:DTCH:PATT #H3F, 8 \*RST value is #H0, 1

**[:SOURce]:W3GPP:MSTation:ENHanced:CHANnel<i>:DTCH:DSElect** 'name'

The command selects a data list for the data of the DTCH channel.

Example: :SOUR:W3GP:MST:ENH:CHAN2:DTCH:DSEL 'test' without \*RST value

**[:SOURce]:W3GPP:MSTation:ENHanced:CHANnel<i>:DCCH** PN9 | PN11 | PN15 | PN16 | ZERO | ONE | PATTErn | DLISt

The command selects the data source for the DCCH channel.

PNx pseudo random sequence of length x

ZERO all bits set to 0

ONE all bits set to 1

PATTErn bit pattern selected with :W3GP:MST:ENH:CHAN2:DCCH:PATT

DLISt data list selected with :W3GP:MST:ENH:CHAN2:DCCH:DSEL

Example: :SOUR:W3GP:MST:ENH:CHAN2:DCCH PN11 \*RST value is PN15

**[:SOURce]:W3GPP:MSTation:ENHanced:CHANnel<i>:DCCH:PATTern** #B0 to #B111..1, 1 to 24

The command defines a bit pattern for the data of the DCCH channel. The first parameter sets the bit pattern (optionally in hex, oct or bin notation), the second one indicates the number of bits to be used.

Example: :SOUR:W3GP:MST:ENH:CHAN2:DCCH:PATT #H3F, 8 \*RST value is #H0, 1

**[:SOURce]:W3GPP:MSTation:ENHanced:CHANnel<i>:DCCH:DSElect** 'name'

The command selects a data list for the data of the DCCH channel.

Example: :SOUR:W3GP:MST:ENH:CHAN2:DCCH:DSEL 'test' without \*RST value

**[:SOURce]:W3GPP:MSTation:ADDITIONal...**

The commands with which up to 50 further secondary mobile stations – in addition to the 4 primary mobile stations – can be added are under this node. The settings for them are based on the settings of primary mobile station 4. The commands are only available if option SMIQB48 is installed. They are only effective if the LINK direction is set to REVerse (SOUR:W3GP:LINK REV).

**[:SOURce]:W3GPP:MSTation:ADDITIONal:STATE** ON | OFF

The command switches the additional mobile stations on or off.

Example: :SOUR:W3GP:MST:ADD:STAT ON \*RST value is OFF

**[[:SOURce]:W3GPp:MSTation:ADDITIONal:COUNt 1 to 50**

The command determines the number of additional mobile stations.

Example: :SOUR:W3GP:MST:ADD:COUN 6

\*RST value is 4

**[[:SOURce]:W3GPp:MSTation:ADDITIONal:SCODE:STEP #H1 to #H1000**

The command sets the initialization increment of the scrambling code – relative to mobile station 4.

Example: :SOUR:W3GP:MST:ADD:SCOD:STEP #H55

\*RST value is #H1

**[[:SOURce]:W3GPp:MSTation:ADDITIONal:POWER:OFFset -20.0 to 20.0 dB**

The command sets the power offset of the additional mobile stations relative to the powers of the primary mobile stations.

Example: :SOUR:W3GP:MST:ADD:POW:OFFS -3.1

\*RST value is 0

**3.5.15 SOURce2 System**

The SOURce2 system contains the commands to configure the LF signal source. It is designated as INT if used as a modulation source (cf. command `SOURce:AM:SOURce INT`, e.g.).

The commands to set the output voltage of the LF generators are in the OUTPut2 system.

Subsystems	Settings
<b>:SOURce2</b> <b>:FREQuency</b> <b>:MARKer</b> <b>:SWEep</b>	Frequency with CW and sweep operation. Marker for LF sweeps (only possible using SOURce2) LF sweep (only possible using SOURce2)

**3.5.15.1 SOURce2:FREQuency Subsystem**

This subsystem contains the commands for the frequency settings in operating modes CW and SWEep for the LF generator.

Command	Parameter	Default Unit	Remark
<b>:SOURce2</b> <b>:FREQuency</b> <b>[:CW]:FIXed]</b> <b>:MANual</b> <b>:MODE</b> <b>:STARt</b> <b>:STOP</b>	0.1 Hz to 1 MHz 0.1 Hz to 1 MHz CW FIXed   SWEep 0.1 Hz to 1 MHz 0.1 Hz to 1 MHz	Hz Hz Hz Hz	

**:SOURce2:FREQuency[:CW | :FIXed] 0.1 Hz to 1 MHz**

The command sets the frequency for the CW mode.

\*RST value is 1 kHz

Example: `:SOUR2:FREQ: CW 1kHz`

**:SOURce2:FREQuency:MANual 0.1 Hz to 1 MHz**

The command sets the frequency if

`:SOURce2:SWEep:MODE Manual` and `SOURce2:FREQuency:MODE SWEep` are set. In this case, only frequency values between the settings `SOURce2:FREQuency:STARt` and `...:STOP` are allowed.

Example: `:SOUR2:FREQ:MAN 1kHz`

\*RST value is 1kHz

**:SOURce2:FREQuency:MODE** CW|FIXed | SWEep

The command specifies the operating mode and hence by means of which commands the FREQuency subsystem is checked. The following allocations are valid:

**CW |FIXed** CW and FIXed are synonyms. The output frequency is specified by means of `SOURce2:FREQuency:CW |FIXed`.

**SWEep** The generator operates in the SWEep mode. The frequency is specified by means of commands `SOURce2:FREQuency:STARt; STOP; MANual`.

Example: `:SOUR2:FREQ:MODE CW` \*RST value is CW

**:SOURce2:FREQuency:STARt** 0.1 Hz to 1 MHz

This command indicates the starting value of the frequency for the sweep.

Example: `:SOUR2:FREQ:STAR 100kHz` \*RST value is 1kHz

**:SOURce2:FREQuency:STOP** 0.1 Hz to 1 MHz

This command indicates the end value of the frequency for the sweep.

Example: `:SOUR2:FREQ:STOP 200kHz` \*RST value is 100 kHz



**3.5.15.2 SOURce2:MARKer Subsystem**

This subsystem contains the commands to check the marker generation in the case of LF sweeps. The three markers existing are differentiated by a numeric suffix after marker.

Command	Parameter	Default Unit	Remark
:SOURce2 :MARKer1 2 3 [:FSweep] :AOFF :FREquency [:STATe] :POLarity	0.1 Hz to 1 MHz ON   OFF NORMal   INVerted	Hz	Option SM-B2/B6  No query

**:SOURce2:MARKer1|2|3[:FSweep]**

The commands for the markers with the LF frequency sweep (Frequency Sweep) are under this node. Keyword [:FSweep] can also be omitted, then the command conforms to SCPI regulation (see examples).

**:SOURce2:MARKer1|2|3[:FSweep]:AOFF**

The command switches off all LF frequency markers. This command triggers an event, thus is has no \*RST value and no query form.

Example:        :SOUR2:MARK:AOFF

**:SOURce2:MARKer1|2|3[:FSweep]:FREquency 0.1 Hz to 1 MHz**

The command sets the marker selected by the numeric suffix at MARKer to the frequency indicated.

\*RST value for MARK1: 100kHz  
MARK2: 10kHz  
MARK3: 1kHz

Example:        :SOUR2:MARK1:FREQ 9000

**:SOURce2:MARKer1|2|3[:FSweep][:STATe] ON | OFF**

The command switches on or off the marker selected by the numeric suffix at MARKer.

Example:        :SOUR2:MARK1:STAT ON                                        \*RST value is OFF

**:SOURce2:MARKer1|2|3:POLarity NORMal | INVerted**

The command specifies the polarity of the marker signal as follows:

**NORMal**        When running through the marker condition, TTL level is applied at the marker output, otherwise 0 V.

**INVers**        When running through the marker condition, 0 V is applied at the marker output, otherwise TTL level.                                        \*RST value is NORM

Example:        :SOUR2:MARK1:POL INV

### 3.5.15.3 SOURce2:SWEep Subsystem

This subsystem contains the commands to check the LF sweep of SOURce2. Sweeps are triggered on principle.

Command	Parameter	Default Unit	Remark
:SOURce2 :SWEep :BTIMe [:FREQuency] :DWELI :MODE :POINts :SPACing :STEP [:LINear] :LOGarithmic	NORMAl   LONG  1 ms to 1 s AUTO   MANual   STEP Number LINear   LOGarithmic  0 to 500 kHz 0.01 PCT to 50 PCT	s      Hz PCT	Option SM-B2

#### :SOURce2:SWEep:BTIMe NORMAl | LONG

The command sets the blank time (Blank TIME) of the sweep. The setting is valid for all sweeps, i.e., also for RF sweeps

NORMAl Blank time as short as possible.

LONG Blank time long enough to permit an X/Y recorder to return to 0.

Example: :SOUR2:SWE:BTIM LONG \*RST value is NORM

#### :SOURce2:SWEep[:FREQuency]

The commands to set the frequency sweeps are under this node. Keyword [:FREQuency] can be omitted. Then the commands are SCPI-compatible unless stated otherwise (see examples).

#### :SOURce2:SWEep[:FREQuency]:DWELI 1 ms to 1 s

The command sets the time per frequency step (dwell).

Example: :SOUR2:SWE:DWEL 20ms \*RST value is 15 ms

#### :SOURce2:SWEep[:FREQuency]:MODE AUTO | MANual | STEP

The command specifies the run of the sweep.

AUTO Each trigger triggers exactly one entire sweep cycle.

STEP Each trigger triggers only one sweep step (single-step mode). The frequency increases by the value indicated under :SOURce2:SWEep

Example: :SOUR2:SWE:MODE AUTO \*RST value is AUTO

**:SOURce2:SWEEP[:FREQUENCY]:POINTS** Number

The command determines the number of steps in a sweep. Instead of this command, commands :SOURce2:FREQUENCY:STEP:LINEar and :SOURce2 :FREQUENCY:STEP:LOGarithmic should be used, as :SOURce2:SWEEP:FREQUENCY: POINTs has been adapted to the instrument characteristics in comparison to the SCPI command. The value of POINTs depends on SPAN and STEP according to the following formulas.

The following is true of linear sweeps :  $POINTS = SPAN / STEP:LIN + 1$

The following is true of logarithmic sweeps and START < STOP:  
 $POINTS = ((\log STOP \log START) / \log STEP:LOG) + 1$

Two independent POINTs values are used for SPACing LOG and SPACing LIN. That is to say, before POINTs is changed, SPACing must be set correctly. A change of POINTs causes an adaption of STEP, but not of START, STOP and SPAN.

Example: :SOUR2:SWEEP:POIN 50

**:SOURce2:SWEEP[:FREQUENCY]:SPACING** LINear | LOGarithmic

The command selects whether the steps have linear or logarithmic spacings.

Example: :SOUR2:SWEEP:SPAC LOG \*RST value is LINear

**:SOURce2:SWEEP[:FREQUENCY]:STEP**

The commands to set the step width with linear and logarithmic sweeps are under this node. The settings of STEP:LIN and STEP:LOG are independent of each other.

**:SOURce2:SWEEP[:FREQUENCY]:STEP[:LINEar]** 0 to 500 kHz

The command sets the step width with the linear sweep. If STEP:LINEar is changed, the value of POINTs valid for SPACing:LINEar also changes according to the formula indicated under POINTs. A change of SPAN does not cause a change of STEP:LINEar. Keyword [:LINEar] can be omitted, then the command conforms to SCPI regulation (see example)

Example: :SOUR2:SWEEP:STEP 10kHz \*RST value is 1 kHz

**:SOURce2:SWEEP[:FREQUENCY]:STEP:LOGarithmic** 0.01 to 50PCT

The command indicates the step width factor for logarithmic sweeps. The next frequency value of a sweep is calculated according to (if START < STOP) :

new frequency = prior frequency + STEP:LOG x prior frequency

Thus STEP:LOG indicates the fraction of the prior frequency by which this is increased for the next sweep step. Usually STEP:LOG is indicated in percent, with the suffix PCT having to be used explicitly. If STEP:LOG is changed, the value of POINTs valid for SPACing:LOGarithmic also changes according to the formula stated unde

Example: :SOUR2:SWEEP:STEP:LOG 5PCT \*RST value is 1 PCT

### 3.5.16 STATus System

This system contains the commands for the status reporting system (c.f. Section "Status Reporting System"). \*RST has no influence on the status registers.

Command	Parameter	Default Unit	Remark
:STATus			
:OPERation			
[:EVENT]?			Query only
:CONDition?			Query only
:PTRansition	0 to 32767		
:NTRansition	0 to 32767		
:ENABle	0 to 32767		
:PRESet			No query
:QUESTionable			
[:EVENT]?			Query only
:CONDition?			Query only
:PTRansition	0 to 32767		
:NTRansition	0 to 32767		
:ENABle	0 to 32767		
:QUEue			
[:NEXT]?			Query only

#### :STATus:OPERation

The commands for the STATus:OPERation register are under this node.

#### :STATus:OPERation[:EVENT]?

The command queries the content of the EVENT part of the STATus:OPERation register. In reading out, the content of the EVENT part is deleted.

Example:       :STAT:OPER:EVENT?

Response: 17

#### :STATus:OPERation:CONDition?

The command queries the content of the CONDition part of the STATus:OPERation register. In reading out, the content of the CONDition part is not deleted. The value returned directly reflects the current hardware state.

Example:       :STAT:OPER:COND?

Response: 1

#### :STATus:OPERation:PTRansition 0 to 32767

The command (Positive TRansition) sets the edge detectors of all bits of the STATus:OPERation register from 0 to 1 for the transitions of the CONDition bits.

Example:       :STAT:OPER:PTR 32767

#### :STATus:OPERation:NTRansition 0 to 32767

The command (Negative TRansition) sets the edge detectors of all bits of the STATus:OPERation register from 1 to 0 for the transitions of the CONDition bit.

Example:       :STAT:OPER:NTR 0



## 3.5.17 SYSTEM System

In this system, a number of commands for general functions which are not immediately related to signal generation, are combined.

Command	Parameter	Default Unit	Remark
:SYSTEM			
:BEEPer			
:STATe	ON   OFF		
:COMMunicate			
:GPIB			
:LTERminator	EOI   STANdard		
[:SELF]			
:ADDRess	0 to 30		
:SDATa			
:BAUD	1200   2400   4800   9600   19200   38400   57600   115200		
:SERial			
:CONTRol			
:RTS	ON   IBFull   RFR		
:BAUD	1200   2400   4800   9600   19200   38400   57600   115200		
:PACE	XON   NONE		
:ERRor?			Query only
:KLOCK	ON   OFF		
:MODE	FIXed   MSEQUence		
:MSEQUence			
:CATalog?			Query only
:DELeTe	"Name of sequence"		
:ALL			
:DWELI	50 ms to 60 s {,50 ms to 60 s}	s	
:FREE?			
:MODE	AUTO   STEP		
[:RCL]	1 to 50 {,1 to 50}		
:POINTs?			Query only
:SELeCt	"Name of sequence"		
:PRESet			No query
:PROTect1 2 3			
[:STATe]	ON   OFF , password		
:SECurity			
[:STATe]	ON   OFF		
:SERRor?			Query only
:VERSion?			Query only
:SSAVe	1 to 1000		
:SREStore	1 to 1000		
!	<least significant byte> <most significant byte>		

**:SYSTEM:BEEPer:STATE ON | OFF**

This node contains the commands to set the beeper fitted. \*RST value is OFF  
 Example:       :SYST:BEEP:STAT OFF

**:SYSTEM:COMMunicate:GPIB**

The commands to check the IEC bus are under this node (GPIB = General Purpose Interface Bus)

**:SYSTEM:COMMunicate:GPIB:LTERminator EOI | STANdard**

The command activates the delimiter identification mode.  
 EOI               only signs transmitted with the circuit message EOI are identified. The EOI mode is particularly suitable for binary block transmission where an arbitrary sign not representing a delimiter could accidentally have the value LF  
 STANdard        LF (with or without EOI) is identified as a delimiter as well.  
 Example:       :SYST:COMM:GPIB:LTER EOI \*RST value is STAN

**:SYSTEM:COMMunicate:GPIB[:SELF]:ADDRess 1 to 30**

The command sets the IEC bus instrument address. \*RST value is 28  
 Example:       :SYST:COMM:GPIB:ADDR 1

**:SYSTEM:COMMunicate:SDATa:BAUD 1200| 2400| 4800| 9600| 19200| 38400| 57600| 115200**

The commands sets the baud rate for the asynchronous data (connector SERDATA) for digital modulation and digital standards.. \*RST has no influence on this parameter.  
 Example:       :SYST:COMM:SDAR:BAUD 1200 \*RST value is 9600

**:SYSTEM:COMMunicate:SERial**

The command to set the serial interface are under this node. The data format is fixedly set to 8 data bits, no parity and 1 stop bit. These values cannot be changed. The device represents a DTE (Data Terminal Equipment) in relation to the serial interface. Therefore the the controller must be connected via a 0-modem.

**:SYSTEM:COMMunicate:SERial:BAUD 1200| 2400| 4800| 9600| 19200| 38400| 57600| 115200**

The commands sets the baud rate for both the transmit and the receive direction. \*RST has no influence on this parameter.  
 Example:       :SYST:COMM:SER:BAUD 1200 \*RST value is 9600

**:SYSTEM:COMMunicate:SERial:CONTrol:RTS ON | IBFull | RFR**

he commands sets the hardware handshake. \*RST has no influence on this parameter.  
 ON               Interface line RTS is always active.  
 IBFull | RFR    Input Buffer Full | Ready For Receiving. Interface line RTS remains active as long as the instrument is ready to receive data  
 Example:       :SYST:COMM:SER:CONT:RTS ON \*RST value is RFR

**:SYSTem:COMMunicate:SERial:PACE** XON | NONE

The command sets the software handshake. \*RST has no influence on this parameter.

XON Software handshake using the ASCII codes 11h (XON) and 13h (XOFF).

**Note:** *This mode is not recommended for binary data and for baud rates above 9600 bauds.*

NONE No software handshake.

Example: :SYST:COMM:SER:PACE NONE

\*RST value is NONE

**:SYSTem:ERRor?**

The command queries the entry that has been in the error queue for the longest time. Positive error numbers denote errors specific of the instrument, negative error numbers denote error messages specified by SCPI (see annex B). If the error queue is empty, 0, "No error", is returned. The command is identical to STATus:QUEue:NEXT?

Example: :SYST:ERR? Response: -221, "Settings conflict"

**:SYSTem:KLOCK** ON | OFF

The command (Keyboard LOCK) disables the keyboard of the SMIQ including the [LOCAL] key or enables it again (OFF).

**Caution:** *If :SYSTem:SECurity is ON, the keyboard cannot be enabled, i.e., :SYSTem:KLOCK OFF is not accepted. If the disabling of the command is released by switching over to :SYSTem:SECurity OFF, data will be lost.*

Example: :SYST:KLOC ON

\*RST value is OFF

**:SYSTem:MODE** FIXed | MSEQence

The command sets the operating mode of the instrument.

FIXed The overall instrument state can only be switched over using \*RCL.

MSEQence The instrument successively sets the instrument states indicated under :SYSTem:MSEQence:RCL. \*RST value is FIXed

Example: :SYST:MODE FIX

**:SYSTem:MSEQence**

This node follows the SOURce:LIST system. It can manage several memory sequences which each consist of a list of instrument state numbers and a time list. If :SYSTem:MODE is switched to MSEQence, the instrument states stated in the list selected are set successively for the time stated in the time list in each case.

**:SYSTem:MSEQence:CATalog?**

The command queries the memory sequences available. It returns a list, the entries are separated by means of commas.

Example: :SYST:MSEQ:CAT?

Response: "SEQ1", "DEMO", "SEQA"







**:SYSTEM:SERRor?**

This command returns a list of all errors existing at the point of time of the query. This list corresponds to the indication on the ERROR page with manual control (cf. Section Error Messages).

Example:       :SYST:SERR?

Response:   -221, "Settings conflict", 153, "Input voltage out of range"

**:SYSTEM:VERSion?**

The command returns the SCPI version number the instrument acts in accordance with. This command is a query and thus has no \*RST value.

Example:       :SYST:VERS?

Response: 1994.0

**:SYSTEM:SSAVe 1...1000**

This command saves the current device setting at the memory location indicated.

**:SYSTEM:SREStore 1...1000**

This command loads a device status that was stored using the :SYSTEM:SSAVe command (RESTORE). One of 1000 available memory locations is selected by entering a numeral.

**! <least significant byte> <most significant byte>**

This command has the same effect as the :SYSTEM:SREStore command. The setting time however is 300  $\mu$ s less. It is optimized for highest speed and does not comply with the SCPI syntax regulations. Exactly 3 bytes are transmitted including the '!' (which is the identifier of this command). With the last byte, EOI has to be activated as delimiter.

The memory location is binary-coded in the 2 bytes indicated.

### 3.5.18 TEST System

This system contains the commands to execute the selftest routines (RAM?, ROM? FSIM?, MCODE?, BERT? and BATTERY?) as well as to directly manipulate the hardware modules (:TEST:DIRECT). The selftests return a "0" if the test has been executed successfully, otherwise a value unequal to "0". All commands of this system do not have an \*RST value.

**Caution:** *The commands under node :TEST:DIRECT directly act on the respective hardware module circumventing any security mechanisms. They are provided for service purposes and should not be used by the user. Improper use of the commands may damage the module.*

Command	Parameter	Default Unit	Remark
:TEST			
:DIRECT			
:ATTC	Subaddress, hex data string		
:DGEN	Subaddress, hex data string		
:DSYN0MUX	Subaddress, hex data string		
:DSYN1MUX	Subaddress, hex data string		
:FMOD	Subaddress, hex data string		
:FSIM1M	Subaddress, hex data string		
:FSIM2M	Subaddress, hex data string		
:IQCON	Subaddress, hex data string		
:IQMOD	Subaddress, hex data string		
:MCOD	Subaddress, hex data string		
:REFSS	Subaddress, hex data string		
:NDSim	Subaddress, hex data string		
:ROSC	Subaddress, hex data string		
:SUM	Subaddress, hex data string		
:MCOD?			Query only
:MCOD			
:DATA?			Query only
:BERT?			Query only
:FSIM?			Query only
:RAM?			Query only
:ROM?			Query only
:BATTERY			
[:RAM]?			Query only
:DGEN?			Query only

#### :TEST:DIRECT

This node contains the commands directly acting on the respective hardware module circumventing any security mechanisms. The commands under this node have no short form.

**:TEST:DIRect:ATTC** Subaddress, hex data string

The command directly acts on module ATTC. A subaddress (0 or 1) must be indicated as a parameter. The data are indicated as a <string> (i.e., an ASCII character string enclosed in quotation marks) representing hexadecimal numbers. Thus characters 0 to 9 A to F may occur in the character string.

Example: `:TEST:DIR:ATTC 0, "0010AF1F"`

Query: `:TEST:DIR:ATTC? 0`

**:TEST:DIRect:DGEN** Subaddress, hex data string

The command acts on module DGEN (cf. `:TEST:DIR:ATTC`).

**:TEST:DIRect:DSYN0MUX** Subaddress, hex data string

The command acts on module DSYN. (cf. `:TEST:DIR:ATTC`)

**:TEST:DIRect:DSYN1MUX** Subaddress, hex data string

The command acts on module DSYN. (cf. `:TEST:DIR:ATTC`)

**:TEST:DIRect:FMOD** Subaddress, hex data string

The command acts on module FMOD. (cf. `:TEST:DIR:ATTC`)

**:TEST:DIRect:FSIM1M** Subaddress, hex data string

The command acts on module FSIM1M. (cf. `:TEST:DIR:ATTC`)

**:TEST:DIRect:FSIM2M** Subaddress, hex data string

The command acts on module FSIM2M. (cf. `:TEST:DIR:ATTC`)

**:TEST:DIRect:IQCON** Subaddress, hex data string

The command acts on module IQCON. (cf. `:TEST:DIR:ATTC`)

**:TEST:DIRect:IQMOD** Subaddress, hex data string

The command acts on module IQMOD. (cf. `:TEST:DIR:ATTC`)

**:TEST:DIRect:MCOD** Subaddress, hex data string

The command acts on module MCOD. (cf. `:TEST:DIR:ATTC`)

**:TEST:DIRect:NDSim** Subaddress, hex data string

The command acts on module NDSIM. (cf. `:TEST:DIR:ATTC`)

**:TEST:DIRect:REFSS** Subaddress, hex data string

The command acts on module REFSS. (cf. `:TEST:DIR:ATTC`)

**:TEST:DIRect:ROSC** Subaddress, hex data string

The command acts on module ROSC. (cf. `:TEST:DIR:ATTC`)

**:TEST:DIRect:SUM** Sub address, hex data string

The command acts on module SUM. (cf. `:TEST:DIR:ATTC`)

**:TEST:MCOD?**

The command triggers a test of the modulation coder.

**:TEST:BERT?**

The command triggers a test of BERT.

**:TEST:FSIM?**

The command triggers a test of the fading simulator.

**:TEST:RAM?**

The command triggers a test of the RAM.

**:TEST:ROM?**

The command triggers a test of the EPROM.

**:TEST:BATTery[:RAM]?**

The command triggers a test of the RAM battery voltage. The voltage should be at least 2.5 V.

**:TEST:BATTery:DGEN?**

The command triggers a test of the battery voltage of the data generator.

### 3.5.19 TRIGger System

The TRIGger system contains the commands to select the trigger source and to configure the external trigger socket. The suffix is only important for the SWEEP subsystem:

TRIGger1 = RF generator

TRIGger2 = LFGEN

The trigger system of the SMIQ is a simplified implementation of the SCPI trigger system. Compared to SCPI, the TRIGger system shows the following differences:

- No INITiate command, the instrument behaves as if INITiate:CONTinuous ON was set.
- There are several subsystems denoting the different parts of the instrument under TRIGger (SWEep, BERT, LIST, DM, MSEQUence).

Further commands as to the trigger system of the SMIQ can be found in the ABORt system.

Command	Parameter	Default Unit	Remark
<b>:TRIGger1 2</b>			
<b>[:SWEep]</b>			
<b>[:IMMediate]</b>			No query
<b>:SOURce</b>	SINGle   EXTernal   AUTO		
<b>:BERT</b>			
<b>[:IMMediate]</b>			No query
<b>:BLER</b>			
<b>[:IMMediate]</b>			No query
<b>:LIST</b>			
<b>[:IMMediate]</b>			No query
<b>:SOURce</b>	SINGle   EXTernal   AUTO   HOP		
<b>:DM</b>			
<b>[:IMMediate]</b>			No query
<b>:SOURce</b>	SINGle   EXTernal   AUTO		
<b>:MSEQUence</b>			
<b>[:IMMediate]</b>			No query
<b>:SOURce</b>	SINGle   EXTernal   AUTO		
<b>:SLOPe</b>	POSitive   NEGative		

#### **:TRIGger1|2[:SWEep]**

All commands to trigger a sweep are under this node. The settings here act on level and frequency sweeps for RF generator (TRIG1) and LF generator (TRIG2).

#### **:TRIGger1|2[:SWEep][:IMMediate]**

The command immediately starts a sweep. Which sweep is executed depends on the respective MODE setting, e.g. :SOURce:FREQuency:MODE SWEep. The command corresponds to manual-control command EXECUTE SINGLE SWEEP. This command triggers an event and thus has no \*RST value.

Example:       :TRIG:SWE:IMM

**:TRIGger1|2[:SWEep]:SOURce** AUTO | SINGle | EXTernal

The command specifies the trigger source. The naming of the parameters directly corresponds to the different settings with manual control. SCPI uses other designations for the parameters the instrument accepts as well. These designations are to be preferred if compatibility is important. The following table provides an overview.

SMIQ designation	SCPI designation	Command with manual control
AUTO	IMMEDIATE	MODE AUTO
SINGle	BUS	MODE SINGLE or STEP
EXTernal	EXTernal	MODE EXT TRIG SINGLE or EXT TRIG STEP

**AUTO** The trigger is free-running, i.e., the trigger requirement is permanently met. As soon as a sweep has been terminated, the next one is started.

**SINGle** Triggering is effected by means of IEC-bus commands `:TRIGger:SWEep:IMMEDIATE` or `*TRG`. If `:SOURce:SWEep:MODE` is set to `STEP`, a step, in the case of the `AUTO` setting a complete sweep, is executed.

**EXTernal** Triggering is effected from outside via the `EXT.TRIG` socket or by the `GET` command via IEC/IEEE-bus (see annex A). The action triggered depends on the setting of the sweep mode as in the case of `SINGle`.

Example: `:TRIG:SWE:SOUR AUTO` \*RST value is `SINGle`

**:TRIGger:BERT[:IMMEDIATE]**

The command immediately starts the BER measurement. It corresponds to command `EXECUTE SINGLE MODE` of the manual control in the `BERT/BER` menu. This command is an event and thus has no `*RST` value.

Example: `:TRIG:BERT:IMM`

The command immediately starts the BLER measurement. It corresponds to the manual control command `EXECUTE SINGLE MODE` in the `BERT/BLER` menu. This command is an event and therefore has no `*RST` value.

Example: `:TRIG:BLER:IMM`

**:TRIGger:LIST**

This node contains all commands to trigger a list in the `LIST` mode.

**:TRIGger:LIST[:IMMEDIATE]**

The command immediately starts the processing of a list of the `LIST` mode. It corresponds to command `EXECUTE SINGLE MODE` of the manual control in the `LIST` menu. This command is an event and thus has no `*RST` value.

Example: `:TRIG:LIST:IMM`







**3.5.20 UNIT System**

This system contains the commands specifying which units are valid if no unit is indicated in a command. These settings are valid for the entire instrument.

Command	Parameter	Default Unit	Remark
:UNIT :ANGLE :POWER	DEGRee   DEGRee   RADian DBM   DBW   DBMW   DBUW   DBV   DBMV   DBUV   V		

**:UNIT:ANGLE** DEGRee | DEGRee | RADian

The command indicates the unit for angles.

\*RST value is RAD

Example:       :UNIT:ANGL DEGR

**:UNIT:POWER** DBM | DBW | DBMW | DBUW | DBV | DBMV | DBUV | V

The command indicates the unit for power.

\*RST value is DBM

Example:       :UNIT:POW V

### 3.6 Instrument Model and Command Processing

The instrument model shown in Fig. 3-2 has been made viewed from the standpoint of the servicing of IEC-bus commands. The individual components work independently of each other and simultaneously. They communicate by means of so-called "messages".

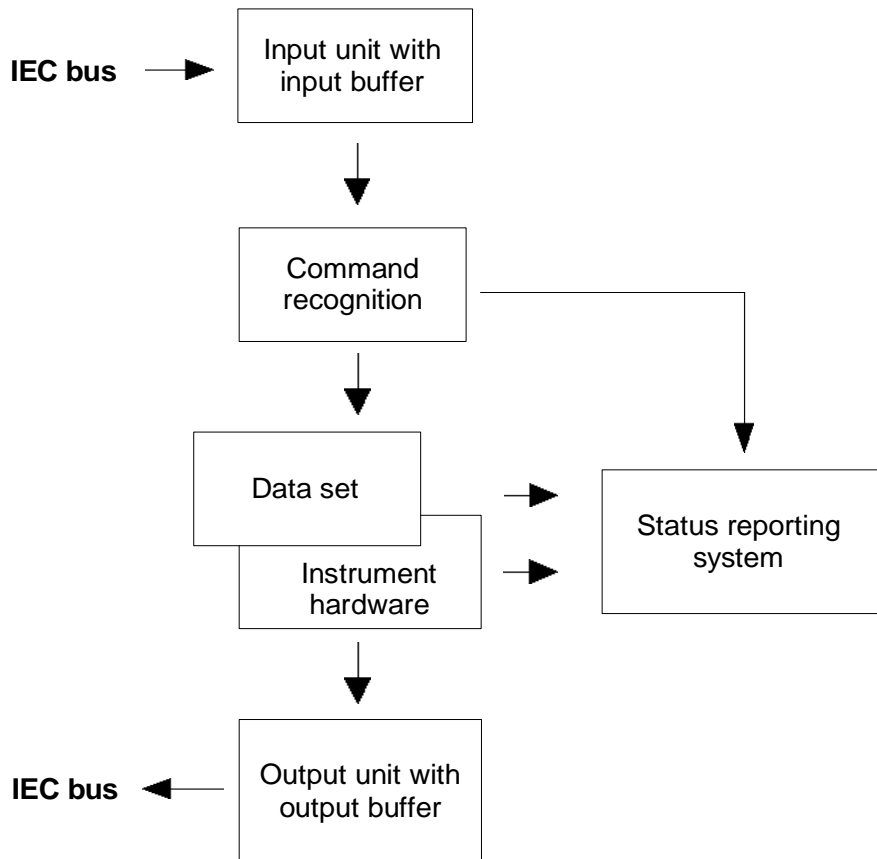

Fig. 3-2 Instrument model in the case of remote control by means of the IEC bus

#### 3.6.1 Input Unit

The input unit receives commands character by character from the IEC bus and collects them in the input buffer. The input buffer has a size of 1024 characters. The input unit sends a message to the command recognition as soon as the input buffer is full or as soon as it receives a delimiter, <PROGRAM MESSAGE TERMINATOR>, as defined in IEEE 488.2, or the interface message DCL.

If the input buffer is full, the IEC-bus traffic is stopped and the data received up to then are processed. Subsequently the IEC-bus traffic is continued. If, however, the buffer is not yet full when receiving the delimiter, the input unit can already receive the next command during command recognition and execution. The receipt of a DCL clears the input buffer and immediately initiates a message to the command recognition.

### **3.6.2 Command Recognition**

The command recognition analyses the data received from the input unit. It proceeds in the order in which it receives the data. Only a DCL is serviced with priority, a GET (Group Execute Trigger), e.g., is only executed after the commands received before as well. Each recognized command is immediately transferred to the data set but without being executed there at once.

Syntactical errors in the command are recognized here and supplied to the status reporting system. The rest of a command line after a syntax error is analyzed further if possible and serviced.

If the command recognition recognizes a delimiter or a DCL, it requests the data set to set the commands in the instrument hardware as well now. Subsequently it is immediately prepared to process commands again. This means for the command servicing that further commands can already be serviced while the hardware is still being set ("overlapping execution").

### **3.6.3 Data Set and Instrument Hardware**

Here the expression "instrument hardware" denotes the part of the instrument fulfilling the actual instrument function - signal generation, measurement etc. The controller is not included.

The data set is a detailed reproduction of the instrument hardware in the software.

IEC-bus setting commands lead to an alteration in the data set. The data set management enters the new values (e.g. frequency) into the data set, however, only passes them on to the hardware when requested by the command recognition. As this is always only effected at the end of a command line, the order of the setting commands in the command line is not relevant.

The data are only checked for their compatibility among each other and with the instrument hardware immediately before they are transmitted to the instrument hardware. If the detection is made that an execution is not possible, an "execution error" is signaled to the status reporting system. All alterations of the data set are canceled, the instrument hardware is not reset. Due to the delayed checking and hardware setting, however, it is permissible to set impermissible instrument states within one command line for a short period of time without this leading to an error message (example: simultaneous activation of FM and PM). At the end of the command line, however, a permissible instrument state must have been reached again.

Before passing on the data to the hardware, the settling bit in the STATus:OPERation register is set. The hardware executes the settings and resets the bit again as soon as the new state has settled. This fact can be used to synchronize command servicing.

IEC-bus queries induce the data set management to send the desired data to the output unit.

### **3.6.4 Status Reporting System**

The status reporting system collects information on the instrument state and makes it available to the output unit on request. The exact structure and function are described in the next section.

### 3.6.5 Output Unit

The output unit collects the information requested by the controller, which it receives from the data set management. It processes it according to the SCPI rules and makes it available in the output buffer. The output buffer has a size of 1024 characters. If the information requested is longer, it is made available "in portions" without this being recognized by the controller.

If the instrument is addressed as a talker without the output buffer containing data or awaiting data from the data set management, the output unit sends error message "Query UNTERMINATED" to the status reporting system. No data are sent on the IEC bus, the controller waits until it has reached its time limit. This behavior is specified by SCPI.

### 3.6.6 Command Sequence and Command Synchronization

What has been said above makes clear that all commands can potentially be carried out overlapping. Equally, setting commands within one command line are not absolutely serviced in the order in which they have been received.

In order to make sure that commands are actually carried out in a certain order, each command must be sent in a separate command line, that is to say, with a separate IBWRT()-call.

In order to prevent an overlapping execution of commands, one of commands \*OPC, \*OPC? or \*WAI must be used. All three commands cause a certain action only to be carried out after the hardware has been set and has settled. By a suitable programming, the controller can be forced to wait for the respective action to occur (cf. Table 3-3).

Table 3-3 Synchronization with \*OPC, \*OPC? and \*WAI

Com-mand	Action after the hardware has settled	Programming the controller
*OPC	Setting the operation-complete bit in the ESR	- Setting bit 0 in the ESE - Setting bit 5 in the SRE - Waiting for service request (SRQ)
*OPC?	Writing a "1" into the output buffer	Addressing the instrument as a talker
*WAI	The next command is executed only after having processed all of the preceding commands.	Sending the next command

An example as to command synchronization can be found in annex D "Program Examples".

### 3.7 Status Reporting System

The status reporting system (cf. Fig. 3-4) stores all information on the present operating state of the instrument, e.g. that the instrument presently carries out an AUTORANGE and on errors which have occurred. This information is stored in the status registers and in the error queue. The status registers and the error queue can be queried via IEC bus.

The information is of a hierarchical structure. The register status byte (STB) defined in IEEE 488.2 and its associated mask register service request enable (SRE) form the uppermost level. The STB receives its information from the standard event status register (ESR) which is also defined in IEEE 488.2 with the associated mask register standard event status enable (ESE) and registers STATus:OPERation and STATus:QUEStionable which are defined by SCPI and contain detailed information on the instrument.

The IST flag ("Individual STatus") and the parallel poll enable register (PPE) allocated to it are also part of the status reporting system. The IST flag, like the SRQ, combines the entire instrument status in a single bit. The PPE fulfills an analog function for the IST flag as the SRE for the service request.

The output buffer contains the messages the instrument returns to the controller. It is not part of the status reporting system but determines the value of the MAV bit in the STB and thus is represented in Fig. 3-4.

#### 3.7.1 Structure of an SCPI Status Register

Each SCPI register consists of 5 parts which each have a width of 16 bits and have different functions (cf. Fig. 3-3). The individual bits are independent of each other, i.e. each hardware status is assigned a bit number which is valid for all five parts. For example, bit 3 of the STATus:OPERation register is assigned to the hardware status "wait for trigger" in all five parts. Bit 15 (the most significant bit) is set to zero for all parts. Thus the contents of the register parts can be processed by the controller as positive integer.

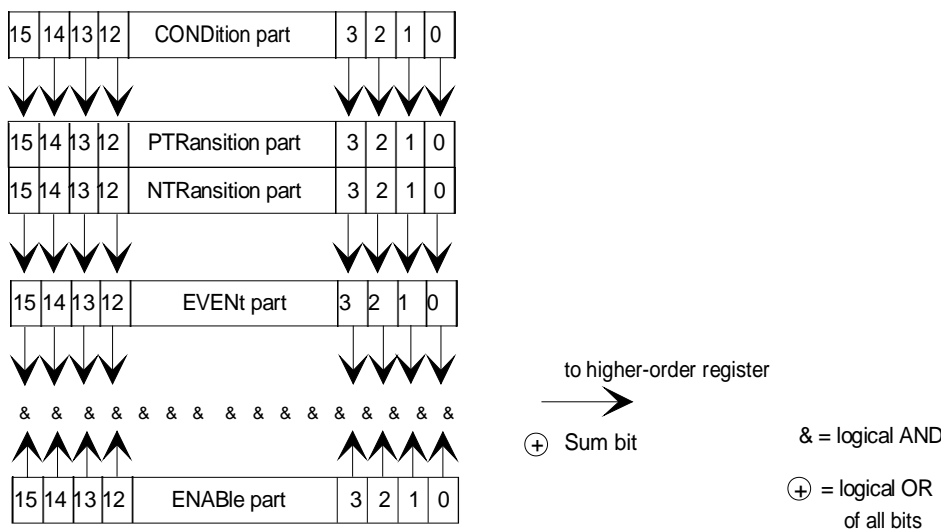

Fig. 3-3 The status -register model

<b>CONDition part</b>	The CONDition part is directly written into by the hardware or the sum bit of the next lower register. Its contents reflects the current instrument status. This register part can only be read, but not written into or cleared. Its contents is not affected by reading.
<b>PTRansition part</b>	The <u>P</u> ositive- <u>T</u> Ransition part acts as an edge detector. When a bit of the CONDition part is changed from 0 to 1, the associated PTR bit decides whether the EVENT bit is set to 1. PTR bit =1: the EVENT bit is set. PTR bit =0: the EVENT bit is not set. This part can be written into and read at will. Its contents is not affected by reading.
<b>NTRansition part</b>	The <u>N</u> egative- <u>T</u> Ransition part also acts as an edge detector. When a bit of the CONDition part is changed from 1 to 0, the associated NTR bit decides whether the EVENT bit is set to 1. NTR bit =1: the EVENT bit is set. NTR bit =0: the EVENT bit is not set. This part can be written into and read at will. Its contents is not affected by reading. With these two edge register parts the user can define which state transition of the condition part (none, 0 to 1, 1 to 0 or both) is stored in the EVENT part.
<b>EVENT part</b>	The EVENT part indicates whether an event has occurred since the last reading, it is the "memory" of the condition part. It only indicates events passed on by the edge filters. It is permanently updated by the instrument. This part can only be read by the user. During reading, its contents is set to zero. In linguistic usage this part is often equated with the entire register.
<b>ENABLE part</b>	The ENABLE part determines whether the associated EVENT bit contributes to the sum bit (cf. below). Each bit of the EVENT part is ANDed with the associated ENABLE bit (symbol '&'). The results of all logical operations of this part are passed on to the sum bit via an OR function (symbol '+'). ENAB bit =0: the associated EVENT bit does not contribute to the sum bit ENAB bit =1: if the associated EVENT bit is "1", the sum bit is set to "1" as well. This part can be written into and read by the user at will. Its contents is not affected by reading.
<b>Sum bit</b>	As indicated above, the sum bit is obtained from the EVENT and ENABLE part for each register. The result is then entered into a bit of the CONDition part of the higher-order register. The instrument automatically generates the sum bit for each register. Thus an event, e.g. a PLL that has not locked, can lead to a service request throughout all levels of the hierarchy.
<b>Note:</b>	<i>The service request enable register SRE defined in IEEE 488.2 can be taken as ENABLE part of the STB if the STB is structured according to SCPI. By analogy, the ESE can be taken as the ENABLE part of the ESR.</i>



3.7.2 Overview of the Status Registers

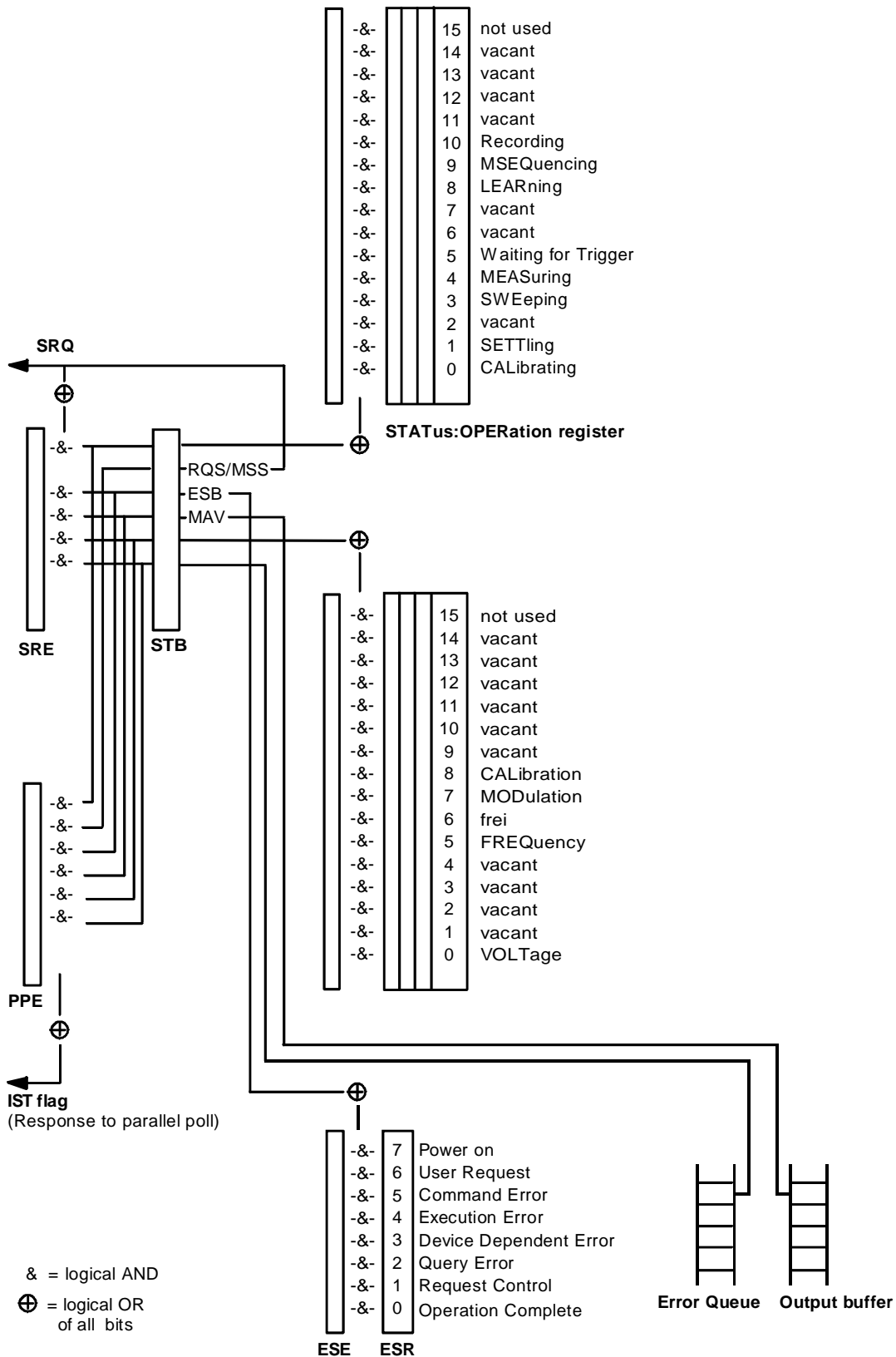

Fig. 3-4 Overview of the status register

### 3.7.3 Description of the Status Registers

#### 3.7.3.1 Status Byte (STB) and Service Request Enable Register (SRE)

The STB is already defined in IEEE 488.2. It provides a rough overview of the instrument status by collecting the pieces of information of the lower registers. It can thus be compared with the CONDition part of an SCPI register and assumes the highest level within the SCPI hierarchy. A special feature is that bit 6 acts as the sum bit of the remaining bits of the status byte.

The STATUS BYTE is read out using the command "\*STB?" or a serial poll.

The STB implies the SRE. It corresponds to the ENABLE part of the SCPI registers as to its function. Each bit of the STB is assigned a bit in the SRE. Bit 6 of the SRE is ignored. If a bit is set in the SRE and the associated bit in the STB changes from 0 to 1, a Service Request (SRQ) is generated on the IEC bus, which triggers an interrupt in the controller if this is appropriately configured and can be further processed there.

The SRE can be set using command "\*SRE" and read using "\*SRE?".

Table 3-4 Meaning of the bits used in the status byte

Bit no.	Meaning
2	<p><b>Error Queue not empty</b></p> <p>The bit is set when an entry is made in the error queue. If this bit is enabled by the SRE, each entry of the error queue generates a Service Request. Thus an error can be recognized and specified in greater detail by polling the error queue. The poll provides an informative error message. This procedure is to be recommended since it considerably reduces the problems involved with IEC-bus control.</p>
3	<p><b>QUESTionable status sum bit</b></p> <p>The bit is set if an EVENT bit is set in the QUESTionable status register and the associated ENABLE bit is set to 1. A set bit indicates a questionable instrument status, which can be specified in greater detail by polling the QUESTionable status register.</p>
4	<p><b>MAV-Bit (Message <u>A</u>vailable)</b></p> <p>The bit is set if a message is available in the output buffer which can be read. This bit can be used to enable data to be automatically read from the instrument to the controller (cf. annex D, program examples).</p>
5	<p><b>ESB bit</b></p> <p>Sum bit of the event status register. It is set if one of the bits in the event status register is set and enabled in the event status enable register. Setting of this bit implies a serious error which can be specified in greater detail by polling the event status register.</p>
6	<p><b>MSS-Bit (Master <u>S</u>tatus <u>S</u>ummary bit)</b></p> <p>The bit is set if the instrument triggers a service request. This is the case if one of the other bits of this register is set together with its mask bit in the service request enable register SRE.</p>
7	<p><b>OPERation status register sum bit</b></p> <p>The bit is set if an EVENT bit is set in the OPERation status register and the associated ENABLE bit is set to 1. A set bit indicates that the instrument is just performing an action. The type of action can be determined by polling the OPERation status register.</p>

### 3.7.3.2 IST Flag and Parallel Poll Enable Register (PPE)

By analogy with the SRQ, the IST flag combines the entire status information in a single bit. It can be queried by means of a parallel poll or using command "\*IST?".

The parallel poll enable register (PPE) determines which bits of the STB contribute to the IST flag. The bits of the STB are ANDed with the corresponding bits of the PPE, with bit 6 being used as well in contrast to the SRE. The Ist flag results from the ORing of all results. The PPE can be set using commands "\*PRE" and read using command "\*PRE?".

### 3.7.3.3 Event Status Register (ESR) and Event Status Enable Register (ESE)

The ESR is already defined in IEEE 488.2. It can be compared with the EVENT part of an SCPI register. The event status register can be read out using command "\*ESR?".

The ESE is the associated ENABLE part. It can be set using command "\*ESE" and read using command "\*ESE?".

Table 3-5 Meaning of the bits used in the event status register

Bit No.	Meaning
0	<b>Operation Complete</b> This bit is set on receipt of the command *OPC exactly when all previous commands have been executed.
2	<b>Query Error</b> This bit is set if either the controller wants to read data from the instrument without having sent a query, or if it does not fetch requested data and sends new instructions to the instrument instead. The cause is often a query which is faulty and hence cannot be executed.
3	<b>Device-dependent Error</b> This bit is set if a device-dependent error occurs. An error message with a number between -300 and -399 or a positive error number, which denotes the error in greater detail, is entered into the error queue (cf. annex B, Error Messages).
4	<b>Execution Error</b> This bit is set if a received command is syntactically correct, however, cannot be performed for other reasons. An error message with a number between -200 and -300, which denotes the error in greater detail, is entered into the error queue (cf. annex B, Error Messages).
5	<b>Command Error</b> This bit is set if a command which is undefined or syntactically incorrect is received. An error message with a number between -100 and -200, which denotes the error in greater detail, is entered into the error queue (cf. annex B, Error Messages).
6	<b>User Request</b> This bit is set on pressing the LOCAL key, i.e., when the instrument is switched over to manual control.
7	<b>Power On</b> (supply voltage on) This bit is set on switching on the instrument.

### 3.7.3.4 STATus:OPERation Register

In the CONDition part, this register contains information on which actions the instrument is being executing or, in the EVEnt part, information on which actions the instrument has executed since the last reading. It can be read using commands "STATus:OPERation:CONDition?" or "STATus:OPERation[:EVEnt]?"..

Table 3-6 Meaning of the bits used in the STATus:OPERation register

Bit-No.	Meaning
0	<b>CALibrating</b> This bit is set as long as the instrument is performing a calibration.
1	<b>SETTling</b> This bit is set as long as the new status is settling after a setting command. It is only set if the settling time is longer than the command processing time.
3	<b>SWEeping</b> This bit is set while the instrument is performing a sweep.
4	<b>MEASuring</b> This bit is set while the instrument is performing a measurement.
5	<b>WAIT for TRIGGER</b> This bit is set as long as the instrument is waiting for a trigger event.
8	<b>LEARning</b> This bit is set while the instrument is "learning" a list.
9	<b>MSEQuencing</b> This bit is set while the instrument is performing a memory sequence.
10	<b>RECording</b> This bit is set while the instrument is recording external data via the DATA input.

### 3.7.3.5 STATus:QUEStionable Register

This register contains information on questionable instrument states. They can occur, e.g. if the instrument is operated out of its specifications. It can be queried using commands "STATus:QUEStionable:CONDition?" or "STATus:QUEStionable[:EVENT]?".

Table 3-7 Meaning of the bits used in the STATus:QUEStionable register

Bit-No.	Meaning
0	<p><b>VOLTage</b></p> <p>This bit is set if the voltage at an output connector is not correct, if the voltage is above or below the specified limit values, if the level limit has responded, if the overvoltage protection has responded.</p>
5	<p><b>FREQuency</b></p> <p>The bit is set if a frequency at the RF output is not correct or if it is lower or higher than the specified values</p>
7	<p><b>MODulation</b></p> <p>The bit is set if a modulation is not correct or is operated outside the specifications.</p>
8	<p><b>CALibration</b></p> <p>The bit is set if a calibration is not performed properly.</p>

### 3.7.4 Application of the Status Reporting Systems

In order to be able to effectively use the status reporting system, the information contained there must be transmitted to the controller and further processed there. There are several methods which are represented in the following. Detailed program examples are to be found in annex D, Programming Examples.

#### 3.7.4.1 Service Request, Making Use of the Hierarchy Structure

Under certain circumstances, the instrument can send a service request (SRQ) to the controller. Usually this service request initiates an interrupt at the controller, to which the control program can react with corresponding actions. As evident from Fig. 3-4, an SRQ is always initiated if one or several of bits 2, 3, 4, 5 or 7 of the status byte are set and enabled in the SRE. Each of these bits combines the information of a further register, the error queue or the output buffer. The corresponding setting of the ENABLE parts of the status registers can achieve that arbitrary bits in an arbitrary status register initiate an SRQ. In order to make use of the possibilities of the service request, all bits should be set to "1" in enable registers SRE and ESE.

Examples (cf. Fig. 3-4 and Program Examples, annex D as well):

Use of command `"*OPC"` to generate an SRQ

- Set bit 0 in the ESE (Operation Complete)
- Set bit 5 in the SRE (ESB)

After its settings have been completed, the instrument generates an SRQ.

Indication of the end of a sweep by means of an SRQ with the controller

- Set bit 7 in the SRE (sum bit of the STATus:OPERation register)
- Set bit 3 (sweeping) in the STATus:OPERation:ENABLE.
- Set bit 3 in the STATus:OPERation:NTRansition so as to make sure that the transition of sweeping bit 3 from 1 to 0 (sweep end) is recorded in the EVENT part.

After a sweep has been completed, the instrument generates an SRQ.

The SRQ is the only possibility for the instrument to become active on its own. Each controller program should set the instrument such that a service request is initiated in the case of malfunction. The program should react appropriately to the service request. A detailed example for a service request routine is to be found in annex D, Program Examples.

#### 3.7.4.2 Serial Poll

In a serial poll, just as with command `"*STB"`, the status byte of an instrument is queried. However, the query is realized via interface messages and is thus clearly faster. The serial-poll method has already been defined in IEEE 488.1 and used to be the only standard possibility for different instruments to poll the status byte. The method also works with instruments which do not adhere to SCPI or IEEE 488.2.

The quick-BASIC command for executing a serial poll is `"IBRSP ( )"`. Serial poll is mainly used to obtain a fast overview of the state of several instruments connected to the IEC bus.

### 3.7.4.3 Parallel Poll

In a parallel poll, up to eight instruments are simultaneously requested by the controller by means of a single command to transmit 1 bit of information each on the data lines, i.e., to set the data line allocated to each instrument to logically "0" or "1". By analogy to the SRE register which determines under which conditions an SRQ is generated, there is a parallel poll enable register (PPE) which is ANDed with the STB bit by bit as well considering bit 6. The results are ORed, the result is then sent (possibly inverted) as a response in the parallel poll of the controller. The result can also be queried without parallel poll by means of command `*IST`.

The instrument first has to be set for the parallel poll using quick-BASIC command `IBPPC()`. This command allocates a data line to the instrument and determines whether the response is to be inverted. The parallel poll itself is executed using `IBRPP()`.

The parallel-poll method is mainly used in order to quickly find out after an SRQ which instrument has sent the service request if there are many instruments connected to the IEC bus. To this effect, SRE and PPE must be set to the same value. A detailed example as to the parallel poll is to be found in annex D, Program Examples.

### 3.7.4.4 Query by Means of Commands

Each part of every status register can be read by means of queries. The individual commands are indicated in the detailed description of the registers. What is returned is always a number which represents the bit pattern of the register queried. Evaluating this number is effected by the controller program.

Queries are usually used after an SRQ in order to obtain more detailed information on the cause of the SRQ.

### 3.7.4.5 Error Queue Query

Each error state in the instrument leads to an entry in the error queue. The entries of the error queue are detailed plain-text error messages which can be looked at in the ERROR menu via manual control or queried via the IEC bus using command `SYSTEM:ERROR?`. Each call of `SYSTEM:ERROR?` provides one entry from the error queue. If no error messages are stored there any more, the instrument responds with 0, "No error"

The error queue should be queried after every SRQ in the controller program as the entries describe the cause of an error more precisely than the status registers. Especially in the test phase of a controller program the error queue should be queried regularly since faulty commands from the controller to the instrument are recorded there as well.

### 3.7.5 Resetting Values of the Status Reporting Systems

Table 3-8 comprises the different commands and events causing the status reporting system to be reset. None of the commands, except for \*RST and SYSTem:PRESet influences the functional instrument settings. In particular, DCL does not change the instrument settings.

Table 3-8 Resetting instrument functions

Event	Switching on supply voltage		DCL,SDC  (Device Clear, Selected Device Clear)	*RST or SYSTem:PRESet	STATus:PRESet	*CLS
	Power-On-Status-Clear					
	0	1				
Clear STB,ESR	—	yes	—	—	—	yes
Clear SRE,ESE	—	yes	—	—	—	—
Clear PPE	—	yes	—	—	—	—
Clear EVENT parts of the registers	—	yes	—	—	—	yes
Clear ENABLE parts of all OPERation-and QUESTionable registers, Fill ENABLE parts of all other registers with "1".	—	yes	—	—	yes	—
Fill PTRansition parts with "1" Clear NTRansition parts	—	yes	—	—	yes	—
Clear error queue	yes	yes	—	—	—	yes
Clear output buffer	yes	yes	yes	1)	1)	1)
Clear command processing and input buffer	yes	yes	yes	—	—	—

1) Every command being the first in a command line, i.e. immediately following a <PROGRAM MESSAGE TERMINATOR> clears the output buffer.



## 3.8 Fast Restore Mode

Device settings can be saved and recalled very quickly via the IEC/IEEE bus using the commands described below. 1000 memory locations are available.

In contrast to the SAVE/RECALL function, not the unit parameters but only the setting data of the modules are stored in the Fast Restore mode. RESTORE by means of the ':SYSTEM:SREStore' or '!..' command has an immediate effect on the module. The database (which stores all entries and delivers the display data) is bypassed. This allows a very high setup speed.

### 3.8.1 Commands

#### :SYSTEM:SSAVe 1...1000

This command saves the current device setting at the memory location indicated.

#### :SYSTEM:SREStore 1...1000

This command loads a device status that was stored using the :SYSTEM:SSAVe command (RESTORE). One of 1000 available memory locations is selected by entering a numeral.

#### ! <least significant byte> <most significant byte>

This command has the same effect as the :SYSTEM:SREStore command. The setting time however is 300  $\mu$ s less. It is optimized for highest speed and does not comply with the SCPI syntax regulations. Exactly 3 bytes are transmitted including the '!' (which is the identifier of this command). With the last byte, EOI has to be activated as delimiter. The memory location is binary-coded in the 2 bytes indicated.

#### Example:

RESTORE at memory location 268 (-> 010C hex) corresponds to the following binary command:

```
0010 0001  0000 1100  0000 0001
  '!'      hex 0C    hex 01
```

Binary-coded bytes can usually not be written as printable ASCII characters.

When programmed in C, the above command has the following form:

```
char sendstring[3] = {'!', 0x0C, 0x01}
```

In BASIC, the command string to be output is as follows:

```
'!' + CHR$(12) + CHR$(1)
```

(The pros for CHR\$ are decimal numbers, therefore 12 for 0C hex.)

Since binary-coded bytes may also have the value of the LF (line feed) character which is interpreted as a delimiter, switch over to 'only EOI' as delimiter by selecting ':SYSTEM:COMMunicate:GPIB:LTERminator EOI' prior to using this command.

### 3.8.2 Call-Up and Termination of Operating Mode

After a RESTORE, the database does no longer reflect the device setting which means that

- the displayed values are no longer relevant,
- the desired result is not obtained by a query of setup values.
- normal setting commands may not be executed properly (see below 'Alternative ...')

It is therefore recommended either to use the \*RST command or

to store the device setting prior to using the first RESTORE command by means of the :SYSTem:SSAVe n command and to restore it after the last RESTORE command using :SYSTEM:SRESTore n. The database and the device setting will then match again.

No other commands are required to activate or deactivate this mode.

- Note:**
- *Since the module setting depends on the temperature of the unit, any temperature variation of more than 5°C should be avoided between storage and call-up to ensure the accuracy of the unit.*
  - If the mechanically switched attenuator is switched over due to a RESTORE command, the setting time increases by 15 ms. This can be avoided by setting one of the two functions for interruption-free level setting (:OUTPut:AMODE FIXed or ELECTronic) prior to storing the setting.

### 3.8.3 Effects on Device Settings

The Fast Restore commands have an effect on almost all device settings (see table).

Device settings stored and called up by Fast Restore:	Device settings not stored or called up by Fast Restore:
<ul style="list-style-type: none"> <li>• Frequency incl. reference oscillator</li> <li>• Level - incl. mech. switched attenuator, - incl. user correction, - incl. ALC modes</li> <li>• Analog modulation</li> <li>• Vector modulation</li> <li>• Switch-on/off of digital modulation</li> <li>• LF generator and LF output</li> </ul>	<ul style="list-style-type: none"> <li>• Settings of baseband signal of digital modulation and digital standard</li> <li>• Functions not regarding the RF output signal, eg commands under :SYSTem:... (except for SYSTem:PRESet) or :UNIT:...</li> <li>• Sweep</li> <li>• List mode</li> <li>• Memory sequence</li> </ul>

### 3.8.4 Alternative Use with Other IEC/IEEE-Bus Commands

The alternative use of the RESTORE commands (':SYSTEM:SREStore' or '!..') and normal IEC/IEEE-bus commands is

- useful in case of digital modulation:  
First, the baseband signal is configured by means of normal commands and digital modulation is switched on. Then, digital modulation can be switched on/off by means of the RESTORE commands.
- possible for all commands that do not regard the RF output signal (eg :SYSTEM:..., :UNIT:...),
- normally not possible for all the functions listed in the left column of the above table. In case of doubt, we recommend testing.

### 3.8.5 Synchronization Signal

In the Fast Restore mode a synchronization signal is available at the rear-panel BLANK connector to synchronize other devices.

The BLANK signal is high during settling of the RF output signal and low in the settled state.

## 4 Maintenance and Troubleshooting

The instrument does not need a periodic maintenance. What is necessary is essentially the cleaning of the instrument. However, it is recommended to check the rated data from time to time.

### 4.1 Maintenance

#### 4.1.1 Cleaning the Outside

The outside of the instrument is suitably cleaned using a soft, line-free dustcloth.

**Caution!** *Do not use solvents such as thinners, acetone and similar things in any case, because otherwise the front panel labeling or plastic parts will be damaged.*

#### 4.1.2 Storage

The storage temperature range of the instrument is -40 to +70 degrees Celsius. If the instrument is to be stored for a longer period of time, it must be protected against dust.

### 4.2 Functional Test

The SMIQ carries out a selftest on switching on the instrument and permanently during operation. On switching on, the RAM and ROM contents are checked and the batteries of the non-volatile RAMs are tested. If an error is detected, this is indicated through a corresponding error message. The most important instrument functions are automatically monitored during operation.

If a faulty function is detected in the selftest, ERROR is displayed in the status line. To identify the error, the ERROR menu, in which the error messages are entered, can be called by pressing the [ERROR] key (cf. Chapter 2, Section "Error Messages").

The tests can additionally be called via the menu.

Access to the tests is offered by the UTILITIES - TEST menu.

Menu selection: UTILITIES - TEST

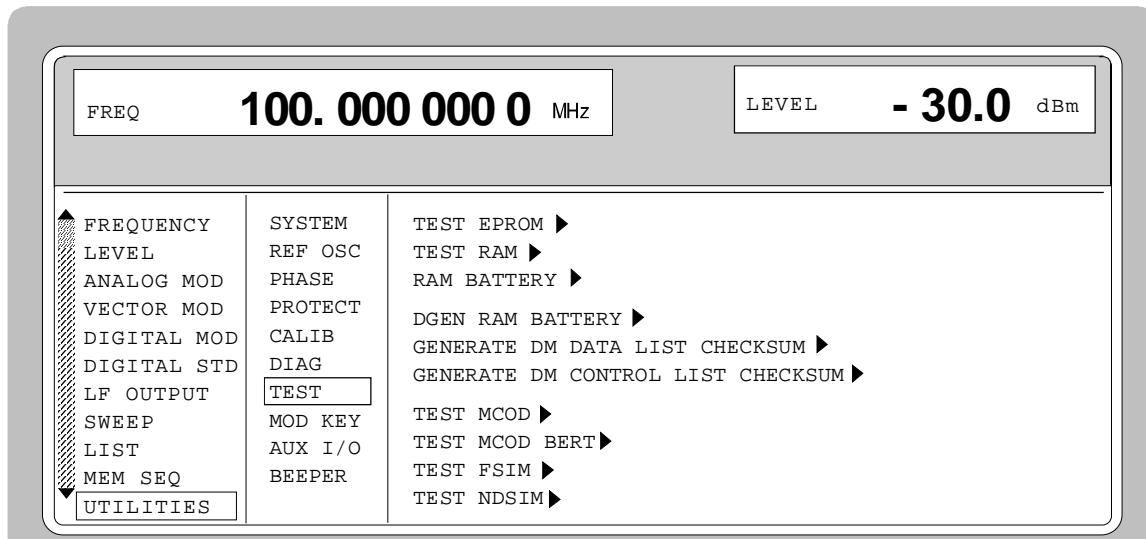

Fig. 4-1 UTILITIES-TEST menu

<b>TEST EPROM ▶</b>	Tests the EPROM. The test result is displayed in a window. IEC/IEEE-bus-command :TEST:BATT:ROM?
<b>TEST RAM ▶</b>	Tests the RAM. The test result is displayed in a window. IEC/IEEE-bus-command :TEST:BATT:RAM?
<b>RAM BATTERY ▶</b>	Tests the RAM battery. The test result is displayed in a window. IEC/IEEE-bus-command :TEST:BATT?
<b>DGEN RAM BATTERY ▶</b>	Tests the RAM battery of the data generator. The test result is displayed in a window. IEC/IEEE-bus-command :TEST:BATT:DGEN?
<b>GENERATE DM DATA LIST CHECKSUM ▶</b>	Calculates the checksum of the active data list. The following algorithm is applied: The entries in the list are interpreted as binary numbers with a length of 32 bits. The most significant bit is on the left side. All 32-bit numbers are added modulo $2^{32}$ . The result is displayed in hexadecimal representation. IEC/IEEE-bus-command :DIAG:DLIS:CHEC :DIAG:DLIS:DATA?
<b>GENERATE DM CONTROL LIST CHECKSUM ▶</b>	Calculates checksum of active control list (algorithm see above). IEC/IEEE-bus-command :DIAG:CLIS:CHEC :DIAG:CLIS:DATA?
<b>TEST MCOD ▶ (only B20)</b>	Tests the modulation coder. The test result is displayed in a window. For further information see Service Manual.
<b>TEST MCOD BERT ▶ (only B20)</b>	Tests BERT on MCOD. Before the test is started, a bit error rate test adapter has to be connected to the BER connector at the rear of the instrument (cf. chapter 5, section "Test Equipment and Test Assemblies").
<b>TEST FSIM ▶</b>	Tests the fading simulator. The test result is displayed in a window. IEC/IEEE-bus-command :TEST:FSIM?
<b>TEST NDSIM ▶</b>	Tests the noise generator and distortion simulator. The test result is displayed in a window. IEC/IEEE-bus-command :TEST:NDSim?

## 5 Checking the Rated Characteristics

### 5.1 Test Equipment and Test Assemblies

#### 5.1.1 Measuring Equipment and Accessories

Table 5-1 Measuring equipment and accessories

Item	Type of Instrument	Required Characteristics	Suitable Instrument	R&S Order No.
1	Frequency counter (included in item 2)	1 Hz to $RF_{max}$ , resolution 0.1 Hz		
2	RF spectrum analyzer	100 Hz to 26 GHz, synthesizer tuning, dynamic range >80 dB	FSIQ26	1119.6001.26
3	Storage oscilloscope	100 Msamples/s, averaging function		
4	Controller	Industry standard PC/XT/AT with IEC-625 interface	PSM17	1116.5004.70
5	Signal generator of high spectral purity	0.1 MHz to $RF_{max}$ , SSB noise level <-126 dBc at 1 GHz/20 kHz	SMIQ02B to 06B	1125.5555.02 to 06
6	Phase noise test assembly	Mixer: 10 MHz to $RF_{max}$ , branching filter 2 MHz, preamplifier with gain of approx. 30 dB, input noise < 2 nV (1 Hz), DC decoupling after mixer for oscilloscope		
7	Oscilloscope (usually included in item 3)	Bandwidth > 100 MHz, two channels with DC coupling		
8	RF power meter	5 kHz to $RF_{max}$	NRVS with NRV-Z51	1020.1809.02 0857.9004.02
9	Precision attenuator	Attenuation 0 to 120 dB, resolution 5 dB	RSG	1009.4505.02
10	Low-noise preamplifier	5 kHz to $RF_{max}$ , gain > 20 dB, noise figure < 10 dB		
11	VSWR bridge	40 kHz to 4 GHz directivity > 40 dB	ZRC	1039.9492.55/52
12	DC voltage source	Setting range 0 to 10 V	NGMD35	0117.7127.02
13	RF power amplifier	10 MHz to $RF_{max}$ , power > 1 W		
14	Audio analyzer	Generator up to 100 kHz, level meter, distortion meter	UPD UPL06	1030.7500.05 1078.2008.06
15	Modulation analyzer	100 kHz to $RF_{max}$ , AM, FM, $\phi M$ , distortion meter, weighting filter ITU-R, ITU-T	FMB with FMA-B1, FMA-B2,	856.5005.52
16	Mixer	10 MHz to $RF_{max}$ , high level		
17	Pulse generator	Pulse repetition frequency up to 10 MHz, TTL level	AFG	377.2100.02
18	Sinewave generator	10 Hz to 8 MHz, 1 V ( $V_{peak}$ ), two channels	ADS, AMIQ	1012.4002.02, 1110.2003.02,

Item	Type of Instrument	Required Characteristics	Suitable Instrument	R&S Order No.
19	AC/DC voltmeter	10 Hz to 8 MHz	URE3	350.5315.03
20	Broadband FM demodulator	Delay line discriminator, input frequency 50 MHz, electrical line length 15 m, demodulation bandwidth 10 MHz		
21	RF attenuator	DC to RF <sub>max</sub> , 3 dB	DNF	0272.4010.50
22	Lowpass filter	Attenuation up to 50 MHz < 1 dB at 100 MHz > 20 dB at 200 MHz > 40 dB		
23	Demodulator for digital modulations	Error vector measurement	Included in item 2, better: FSIQ 3 option K11 (for GSM)	1119.5005.03 1057.3392.02
24	Arbitrary waveform generator	Two channels	AMIQ	1110.2003.02
25	Program for simulation of digital modulations	Generation of data for ARB generator	WinIQSIM, included in item 24	
26	Directional coupler	High directivity, 3.3 GHz to RF <sub>max</sub>	Narda MODEL 3292-1	
27	Test connector for BERT	Type: 9-contact female SUB-D connector. Pin 6 has to be connected to pin 8, pin 7 to pin 9.		
28	Feed-through termination	50 Ω, BNC system	RAD	0289.8966.00
29	BNC adapter	Adaption of D-Sub to BNC	SMIQ-Z5	1104.8555.02

### 5.1.2 Test Assemblies

#### 5.1.2.1 Standard Test Assembly for Analog Modulations

Test equipment

- Modulation analyzer (Table 5-1, item 15)
- Oscilloscope (Table 5-1, item 7, only for a few measurements)

Test setup

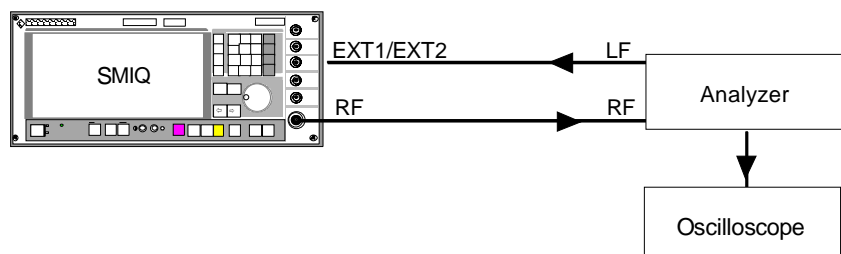

### 5.1.2.2 Test Assembly for Analog Modulations with Audio Analyzer

- Test equipment
- Modulation analyzer (Table 5-1, item 15)
  - Audio analyzer (Table 5-1, item 14)

Test setup

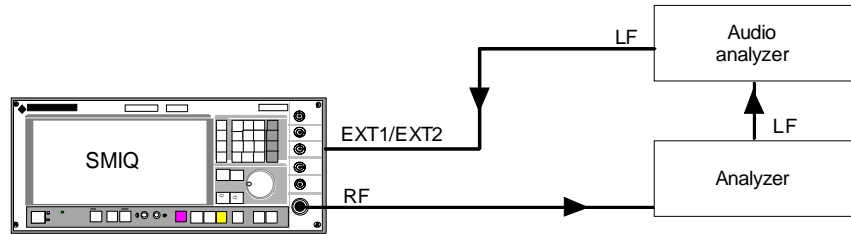

### 5.1.2.3 Test Assembly for Broadband FM

- Test equipment
- Second signal generator (Table 5-1, item 5)
  - Mixer (Table 5-1, item 16)
  - Sinewave generator (Table 5-1, item 18)
  - AC voltmeter (Table 5-1, item 19)
  - Broadband FM demodulator (Table 5-1, item 20)
  - RF attenuator (Table 5-1, item 21)
  - Lowpass filter (Table 5-1, item 22)

Test setup

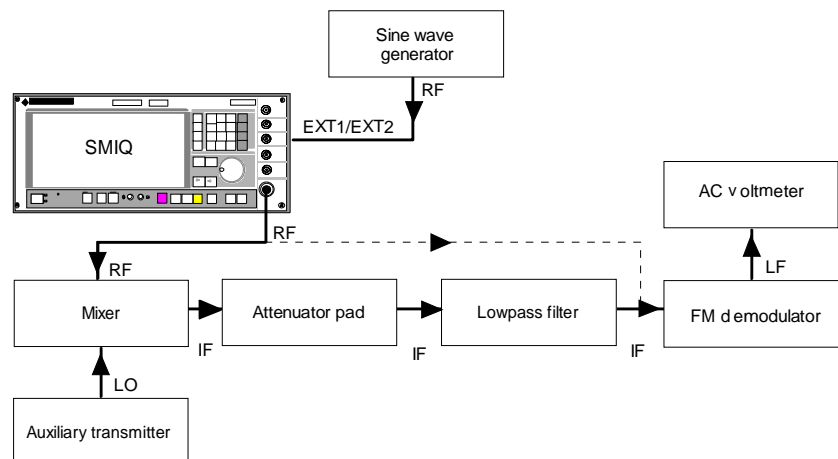



### 5.1.2.4 Test Assembly for Pulse Modulation

Test equipment

- Second signal generator (Table 5-1, item 5)
- Oscilloscope (Table 5-1, item 7)
- Mixer (Table 5-1, item 16)
- Pulse generator (Table 5-1, item 17)
- RF attenuator (Table 5-1, item 21)
- Lowpass filter (Table 5-1, item 22)

Test setup

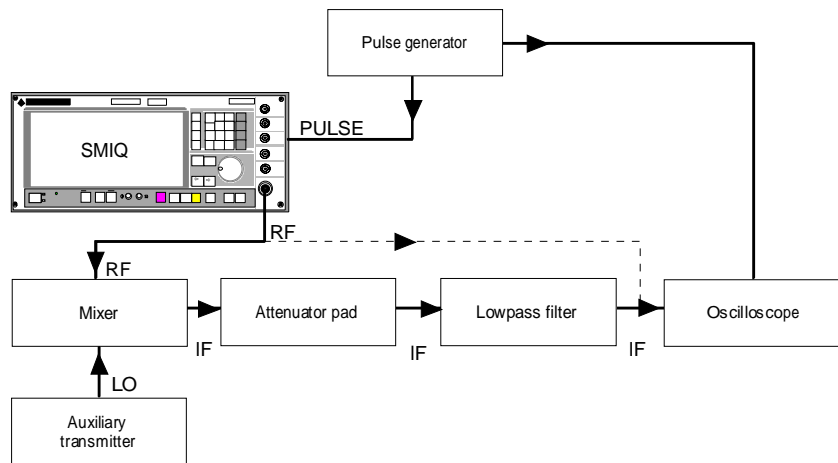

### 5.1.2.5 Test Assembly for Vector Modulation

Test equipment

- Demodulator for digital modulation (Table 5-1, item 23)
- Arbitrary waveform generator (Table 5-1, item 24)
- Program for simulation of digital modulations (Table 5-1, item 25)
- Controller to industry standard (Table 5-1, item 4)

Test setup

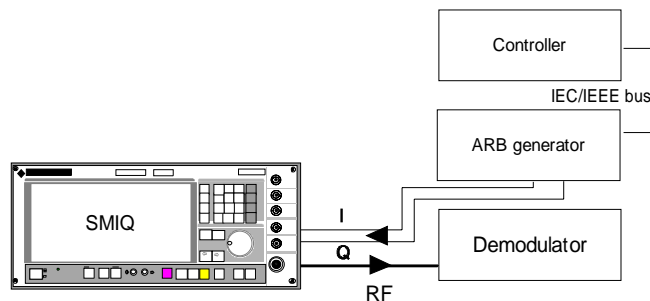

### 5.1.2.6 Test Assembly for SSB Phase Noise

Test equipment

- Second signal generator (Table 5-1 item 5),
- Phase noise test assembly consisting of mixer with lowpass filter and preamplifier (Table 5-1 item 6)
- Oscilloscope (Table 5-1 item 7)
- Spectrum analyzer (Table 5-1 item 2)

Test setup

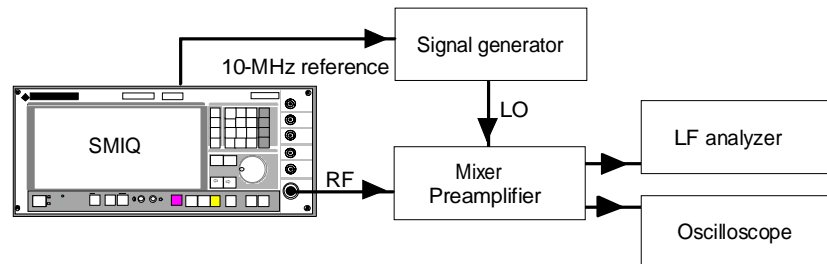

### 5.1.2.7 Test Assembly for Output Impedance (VSWR)

Test equipment

- VSWR bridge (Table 5-1, item 11), for frequencies >3.3 GHz directional coupler (Table 5-2, item 26)
- Second signal generator (Table 5-1, item 5)
- Spectrum analyzer (Table 5-1, item 2)

Test setup

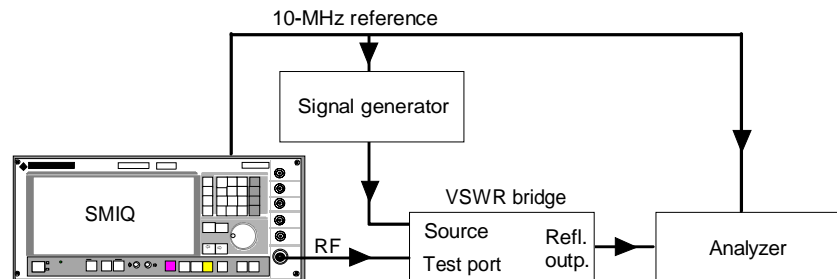

**Note:** The test port of the VSWR bridge has to be screwed directly to the DUT. The INPUT connector of the directional coupler, too, has to be screwed directly to the DUT. The line output of the directional coupler has to be connected to the second signal generator, and the reflection output (-13 dB) to the analyzer.

### 5.1.2.8 Test Assembly with Spectrum Analyzer for Fading Simulation

- Test equipment
- Arbitrary waveform generator (Table 5-1, item 24)
  - Spectrum analyzer (Table 5-1, item 2)

Test setup

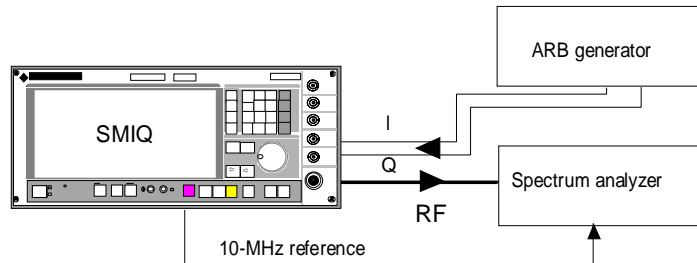

### 5.1.2.9 Test Assembly with Sampling Oscilloscope for Fading Simulation

- Test equipment
- Arbitrary waveform generator (Table 5-1, item 24)
  - Sampling oscilloscope (Table 5-1, item 3)

Test setup

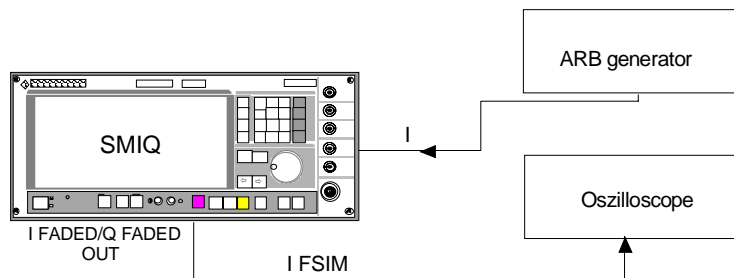

### 5.1.2.10 Test Assembly for Amplitude Settling

- Test equipment
- Spectrum analyzer with video output (Table 5-1, item 2)
  - Storage oscilloscope (Table 5-1, item 3)
  - Pulse generator (Table 5-1, item 17)

Test setup

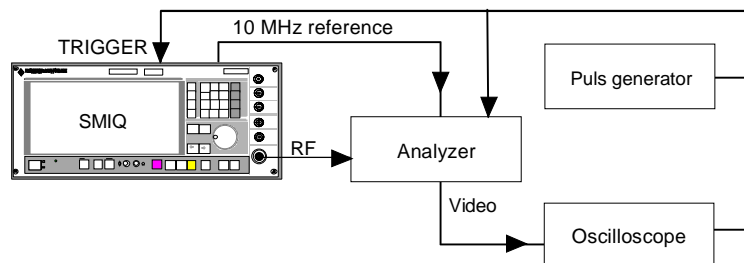

## 5.2 Preparation, Recommended Test Frequencies and Levels

To ensure that rated specifications are maintained and to prevent setting errors, the following preparations must be made prior to checking the rated characteristics:

- At least **30 minutes warmup period**.
- All **internal calibrations** must be carried out (see Chapter 2)
- A defined initial status must be set by pressing the **PRESET key** prior to making the settings for a new measurement.

In the following sections, the procedures for checking the rated specifications are described. **The binding nominal values are specified in the data sheet.**

lists the sampling frequencies for internal calibration (with and without vector modulation). For a full functional test of the instrument, we recommend measurements at these frequencies unless particular test frequencies are given.

The asterisk (\*) marks range limits which constitute the main test frequencies.

Table 5-2 Range limits, main test frequencies with/without vector modulation

Test frequency	Remarks
300 000.0 Hz	*
500 000.0 Hz	
1 000 000.0 Hz	
2 000 000.0 Hz	
3 000 000.0 Hz	
5 000 000.0 Hz	*
5 000 000.1 Hz	*
7 000 000.0 Hz	
10 000 000.0 Hz	
15 000 000.0 Hz	
20 000 000.0 Hz	
25 000 000.0 Hz	
50 000 000.0 Hz	
Every 50 MHz up to 6400 000 000.0 Hz	*

The following range limits **and the 0.1 Hz higher frequencies** are further main (\*) frequencies:

General range limits, CW:	450 MHz, 1500 MHz, 3000 MHz, 3040 MHz
General range limits, VM:	525 MHz, 750 MHz, 1200 MHz, 1800 MHz, 2500 MHz
General range limits, CW and VM:	3300 MHz, 4200 MHz, 5100 MHz, 6000 MHz, 6400 MHz
Oscillator switchover, CW:	1100 MHz, 2200 MHz
Oscillator switchover, VM:	800 MHz, 1500 MHz

Because of the different level algorithms used, the test levels are given separately for the different models. With attenuator switching in steps of 5 dB, it is also possible to perform measurements at lower levels (for example if mixers are used) by lowering the level exactly in 5.0 dB steps. For Signal Analyzer FSIQ, the optimum mixer level is  $-15$  dBm (i.e.  $-5$  dBm at 10 dB attenuation); the level of the SMIQ should have this value.

Model	P <sub>CW</sub> <sub>max</sub>	P <sub>CW</sub> <sub>min</sub>	P <sub>VM</sub> <sub>max</sub>	P <sub>VM</sub> <sub>min</sub>	P <sub>AM</sub> <sub>max</sub>	P <sub>AM</sub> <sub>min</sub>
02, 03, ..A,..E, ..W	10.0 dBm	5.1 dBm	7.0 dBm	2.1 dBm	7.9 dBm at 80% 10.7 dBm at 30%	2.1 dBm
02B, 03B	10.0 dBm	5.1 dBm	8.0* dBm	3.1 dBm	7.9 dBm at 80% 10.7 dBm at 30%	2.1 dBm
04B, 06B	7.0 dBm	2.1 dBm	5.0 dBm	0.1 dBm	4.9 dBm at 80%, 7.7 dBm at 30%	-0.9 dBm

\* For SMIQ B models, OUTPUT MODE NORMAL/LOW\_NOISE/LOW\_DIST has been introduced in the LEVEL menu from software 5.65. Moreover, the level setting algorithms were changed for digital modulation. For these units, the switchover level of the mechanical attenuator must be read under ATTN FIXED RANGE in the LEVEL menu or must be read out under remote control. 5.0 dB below the upper of the given levels switches the attenuator to ATTENUATOR MODE NORMAL. The recommended levels for digital modulation are 4.8 dB and 5.2 dB under this level corresponding to the smallest and largest internal level ahead of the attenuator.

## 5.3 Test Procedures

### 5.3.1 Display and Keyboard

- Checking the display
- Switch instrument on.
    - ⇒ The basic menu is displayed after several seconds.
  - Rotate contrast control (lefthand potentiometer below the display).
    - ⇒ The contrast is varied from dark to bright.
  - Rotate brightness control (righthand potentiometer).
    - ⇒ The brightness of the backlighting is varied.
- Checking the keyboard
- Press keys and check response at the display.

### 5.3.2 Frequency

#### 5.3.2.1 Frequency Setting

- Test equipment
- Frequency counter (Table 5-1, item 1)
- Test method
- The frequency setting is checked using a frequency counter whose reference frequency is synchronized with that of the SMIQ.
- Measurement
- SMIQ setting:
    - test frequency unmodulated,
    - level 0 dBm
  - ⇒ The measured values must be exact within the framework of the counter resolution.

Recommended test frequencies:

CW test frequency	Module under test	Counter resolution
839.1, 839.15, 839.5 MHz	Digital synthesis	0.1 Hz
840 to 940 MHz in 10 MHz steps	Step synthesis	0.1 Hz
800, 850, 1000, 1100, 1200, 1300, 1400, 1490 MHz	Harmonics of summing circuit	10 Hz
450.1, 750 MHz	Divider and harmonic filter of IQ converter	10 Hz
10, 449 MHz	Output mixer of IQ modulator	10 Hz
1501, 2200, 2500, 3300 MHz	Doubler with filters IQCON	10 Hz
3750 MHz, 4400 MHz, 5550 MHz, 6400 MHz	Frequency extension	10 Hz
<b>VM test frequencies, max. level</b>		
500, 800, 1801, 2200, 3300 MHz	Doubler with filters IQCON	10 Hz

### 5.3.2.2 Settling Time

Test assembly	See chapter Test Equipment and Test Assemblies.
Test method	The spectrum analyzer is operated as an edge demodulator with a 0 Hz span. A controller transmits the start and the stop frequency via the IEC bus. The analyzer is triggered by the positive edge on the EOI line of the IEC bus. When the controller switches over from start to stop frequency, the settling procedure is displayed on the screen of the analyzer.
Preparation of measurement	<ul style="list-style-type: none"> <li>➤ Synchronize the reference frequencies of the SMIQ and the analyzer.</li> <li>➤ Make IEC bus and RF connections.</li> <li>➤ Apply trigger connection to EOI line (pin 5) of IEC bus.</li> <li>➤ Settings on SMIQ: <ul style="list-style-type: none"> <li>- Stop frequency unmodulated</li> <li>- Level 0 dBm</li> </ul> </li> <li>➤ Settings on spectrum analyzer: <ul style="list-style-type: none"> <li>- Reference level -5 dBm</li> <li>- Amplitude scale 1 dB/div</li> <li>- Resolution bandwidth 10 kHz</li> <li>- Video bandwidth 100 kHz</li> <li>- Span 30 kHz</li> </ul> </li> <li>➤ Starting from the stop frequency, lower the center frequency of the analyzer until the visible filter edge runs through the center point of the screen.</li> <li>➤ Reduce the span to 0 Hz and calibrate the frequency scale at the analyzer by means of 100 Hz steps on the SMIQ.</li> </ul>
Measurement	<ul style="list-style-type: none"> <li>➤ Settings on analyzer: TRIGGER EXTERN <ul style="list-style-type: none"> <li>- External triggering by positive edge at 1.5 V.</li> </ul> </li> <li>➤ First send the start and then the stop frequency from the controller. <ul style="list-style-type: none"> <li>⇒ The settling curve is displayed on the screen of the externally triggered analyzer.</li> </ul> </li> <li>➤ Repeat the measurement with the start and the stop frequency interchanged.</li> </ul>

⇒ Measure the following steps in both directions:

Test	Setting	F1/MHz	F2/MHz
Step synthesis	CW	840	942
Digital synthesis	CW	1 350.2	1 351.4
Mixer range	CW	1 099	5
Doubler, oscillator change	CW	2201	1099
CW/VM synthesis, 3rd filter	CW	2999	3 001
1st/2nd filter	VM max. level, ALC table	751	1801
2nd/3rd filter	VM max. level, ALC table	1801	2601
Frequency extension	CW	3000	3301
Frequ. extension, 1st/2nd filter	CW	4199	4201
Frequ. extension, 2nd/3rd filter	CW	5099	5101
Frequ. extension, 3rd/4th filter	CW	5999	6001

**QuickBasic program for the controller**

```
CLS
iecadresse% = 28
CALL IBFIND("DEV1", generator%)
CALL IBPAD(generator%, iecadresse%)
iecterm% = &HA '
CALL IBEOS(generator%, iecterm% + &H800)
CALL IBWRT(generator%, "POW 0dBm")
DO
  INPUT "Start frequency in MHz";F1$
  INPUT "Stop frequency in MHz";F2$
  DO
    CALL IBWRT(generator%, "FREQ" + F1$ + "MHz")
    PRINT "Frequency:";F1$; "MHz"
    DO '
      kbd$ = INKEY$
      LOOP UNTIL LEN(kbd$)
      SWAP F1$, F2$
    LOOP UNTIL kbd$ = CHR$(27) '
    INPUT "Repeat (y/n)"; w$
  LOOP UNTIL NOT UCASE$(w$) = "Y"
END
```

IEC/IEEE-bus address of the SMIQ (28)  
 Open DEV1 and obtain access number  
 Set IEC-bus address of DEV1 to 28  
 Set EOS to LINE FEED

Press any key

Exit with ESCAPE

### 5.3.2.3 Setting Time LIST MODE

Test assembly	See section Test Assemblies.
Test method	<p>The spectrum analyzer is operated as a fast level meter with a 0 Hz span. The storage oscilloscope is connected to the video output of the analyzer and triggered by the positive edge of the pulse generator. If it can be ensured that the trigger delay of the spectrum analyzer is sufficiently small, the oscilloscope at the video output can be removed, and the analyzer read directly.</p> <p><i>Note : This is only a function test with a level measurement and cannot be used to measure resolution to 1E-7.</i></p>
Preparation of measurement	<ul style="list-style-type: none"> <li>➤ Synchronize reference frequencies of SMIQ and analyzer.</li> <li>➤ Connect pulse generator as trigger source to the TRIGGER connector of SMIQ, analyzer and oscilloscope. External triggering at 1.5 V, positive edge.</li> <li>➤ Connect storage oscilloscope to video output of analyzer.</li> <li>➤ Settings on SMIQ: In the List mode, enter test frequencies with +10 dBm level and generate list for frequencies F1 and F2.</li> <li>➤ Learn list and set operating mode EXT STEP.</li> <li>➤ Settings on storage oscilloscope: Time base 100 us/div, Sensitivity according to video output of analyzer.</li> <li>➤ Settings on pulse generator: Operating mode CONT, level TTL, frequency 100 Hz</li> <li>➤ Settings on spectrum analyzer: Reference level 10 dBm, Amplitude scale 10 dB/div, Resolution bandwidth 100 kHz, Video bandwidth 300 kHz, Span 0 Hz.</li> </ul>
Measurement	<ul style="list-style-type: none"> <li>➤ Select a list, set center frequency to target frequency F2. <ul style="list-style-type: none"> <li>⇒ The level settling process from the trigger time is displayed on the screen of the externally triggered oscilloscope.</li> </ul> </li> <li>➤ Repeat measurement with target frequency F1. <ul style="list-style-type: none"> <li>⇒ The frequency changes to be tested are the same as those with normal frequency setting.</li> </ul> </li> </ul>



### 5.3.3 Reference Frequency

#### 5.3.3.1 Output of Internal Reference

**Important:** Allow the SMIQ to warm up for at least 2 hours before the measurement.

Test equipment	RF power meter (Table 5-1, item 8), frequency counter (Table 5-1, item 1)
Test setup	Connect an RF power meter to the REF output (socket on rear panel).
Measurement	➤ Measure the output level. It should be within $\pm 3$ dB of the data sheet specifications.
Test setup	➤ Connect a calibrated frequency counter to the REF output (socket on rear panel).
Measurement	➤ Measure the frequency. ⇨ The frequency deviation must not exceed the sum of deviations resulting from the frequency error in the rated temperature range and from aging.

#### 5.3.3.2 Input for External Reference

Test equipment	Frequency counter (Table 5-1, item 1) Signal generator (Table 5-1, item 5)
Test setup	➤ Connect the signal generator to the input for the external reference and connect a calibrated frequency counter to the RF output.
Measurement	➤ Measure the frequency with the setting UTILITIES/REF OSC/SOURCE EXT. ⇨ <i>The pull-in range has to be tested only at 10 MHz input frequency by measuring the output frequency (e.g. at 100 MHz). There must be no relative frequency error and no error message. At the other input frequencies (1 MHz to 16 MHz in steps of 1 MHz), a function test at nominal frequency is sufficient. The level of the signal generator should be -7 dBm, for the function tests it should be raised to 16 dBm.</i>

### 5.3.4 Level

#### 5.3.4.1 Level Uncertainty

The level uncertainty is measured in two steps. First, the frequency response is measured at a fixed level and - based on this - the linearity as relative measurement. Both deviations form the measurement result.

Test equipment	- Power meter (Table 5-1, item 8) - Spectrum analyzer (Table 5-1, item 2) - Low-noise preamplifier (Table 5-1, item 10)
----------------	---

#### Test method for levels in measurement range of power meter

Test setup	➤ Connect power meter to RF output socket.
Measurement	➤ Setting on SMIQ: - RF level to be measured (see below), unmodulated ➤ Measure the level at output frequencies of 300 kHz to $RF_{max}$ . ⇨ The level error is the deviation of the measured level from the set value.

Recommended test levels	P <sub>cw<sub>max</sub></sub> , P <sub>cw<sub>min</sub></sub> and from P <sub>cw<sub>min</sub></sub> in -5 dB steps to the measurement limit of the power meter
Recommended test frequencies for the level frequency response measurement	300k, 1M, 3M, 5M, 9M, 15M, every 10M up to 1495M, 1500M, from 1500M every 20M up to 6400M (all in Hz)
Recommended test frequencies and levels for the level linearity measurement.	Measurement at the frequency where the level frequency response showed the largest deviation, at 300 kHz, 950 MHz, 1850 MHz, (2150 MHz), 3250 MHz, 4350 MHz, 5150 MHz, 6050 MHz and 6350 MHz. Test level: from P <sub>cw<sub>max</sub></sub> in 5 dB steps up to the maximum attenuation of the attenuator (P <sub>cw<sub>max</sub></sub> - 135 dBm)

### Test method for low levels

Test principle	<p>Levels below the measurement range of the power meter can be determined by means of a relative measurement referred to the measurements performed with the power meter, using a high-linearity spectrum analyzer (digital IF).</p> <p>After switching the analyzer attenuator a calibration of the connections should be carried out. It is therefore recommended to switch the attenuator after approx. 50 dB, since the linearity errors are very small in the range up to -50 dBfs (referred to full scale). If the measurement is started at P<sub>cw<sub>max</sub></sub> -40 dBm, no error occurs due to the alternating internal impedance of the DUT, since the 40 dB section at the attenuator output remains switched on.</p>
Test setup	Connect the spectrum analyzer to the RF output of the SMIQ with <b>screened RF measurement cables</b> .
Measurement	<ul style="list-style-type: none"> <li>➤ Settings on SMIQ <ul style="list-style-type: none"> <li>Test frequency</li> <li>Level P<sub>cw<sub>max</sub></sub> -40dBm, unmodulated</li> </ul> </li> <li>➤ Setting on the analyzer <ul style="list-style-type: none"> <li>Test frequency</li> <li>SPAN 0 Hz</li> <li>RES BW 10 Hz</li> <li>SWEEP TIME 150 ms</li> <li>AVERAGE over 8 sweeps</li> <li>Read out marker at 150 ms due to settling</li> <li>Select 1kHz DIG under COUPLING RBW</li> <li>Reference level P<sub>cw<sub>max</sub></sub> -40 dBm</li> </ul> </li> <li>➤ Read the level at the analyzer and define the correction factors as a function of the frequency from the measurements performed with the power meter.</li> <li>➤ Now the measurements between P<sub>cw<sub>max</sub></sub> -45 dBm and P<sub>cw<sub>max</sub></sub> -100 dBm can be carried out.</li> <li>➤ In order to obtain enough spacing to the noise limit of the analyzer, a low-noise preamplifier (Table 5-1, item 10) is looped between the DUT and the analyzer (<b>Caution: screened RF lines!</b>). A calibration of the connections at P<sub>cw<sub>max</sub></sub> -100 dBm is thus required, the reference level of the analyzer should be set such that the measured level is close to the reference level. The number of averages at -80 dBm is doubled to increase measurement accuracy.</li> <li>➤ Now the level steps up to P<sub>cw<sub>max</sub></sub> -135 dBm can be measured.</li> </ul>

### 5.3.4.2 Output Impedance

Test assembly	See section "Test Assemblies".
Test method	<p>Since the VSWR of a source must be measured, a purely passive measurement using the VSWR bridge is only possible with levels where the VSWR is determined by the output impedance of the mechanical attenuator only.</p> <p>With higher levels, the effect of level control must be taken into account. For this purpose, an auxiliary generator is used which transmits a wave with a slightly offset carrier frequency (difference frequency within the control bandwidth of the level control) into the DUT, on which the outgoing wave of the DUT is superimposed. In the case of an ideal source impedance, only the outgoing wave of the DUT flows back into the bridge, in the case of a deviating source impedance, the two components are superimposed on one another, which, due to the frequency offset, results in a beat, from the amplitude ratio of which the VSWR can be derived.</p>
Recommended test frequencies and levels	<p>Test frequencies: every 50 MHz as from 1 GHz.</p> <p>Test levels: <math>P_{CW_{min}}</math>, <math>P_{CW_{min}} - 5</math> dBm, <math>P_{CW_{min}} - 10</math> dBm, <math>P_{CW_{min}} - 20</math> dBm, <math>P_{CW_{min}} - 40</math> dBm, ALC ON and OFF for each level.</p>
Measurement	<ul style="list-style-type: none"> <li>➤ Settings on SMIQ: <ul style="list-style-type: none"> <li>- Test level</li> <li>- Test frequency, unmodulated</li> </ul> </li> <li>➤ Settings on spectrum analyzer: <ul style="list-style-type: none"> <li>- Test frequency, span 0 Hz, test level</li> <li>- Resolution and video bandwidth 10 kHz</li> <li>- Linear level scale</li> <li>- Sweep time 30 ms</li> </ul> </li> <li>➤ Settings on second signal generator: <ul style="list-style-type: none"> <li>- Detune the frequency by 100 Hz compared to the test frequency,</li> <li>- first set minimum level, unmodulated.</li> </ul> </li> <li>➤ Vary the reference level to bring the line displayed on the screen of the spectrum analyzer approximately into the center of the screen and read and note down the level as reference level.</li> <li>➤ Unscrew the VSWR bridge from the SMIQ and increase the level at the second signal generator until the reference level is measured again at the analyzer.</li> <li>➤ Screw the bridge or directional coupler onto the SMIQ again. <ul style="list-style-type: none"> <li>⇒ A more or less wavy line representing the VSWR of the SMIQ is now displayed on the spectrum analyzer.</li> </ul> <p>The VSWR is to be calculated from the maximum and minimum voltage</p> <math display="block">VSWR = V_{max}/V_{min}</math> </li> </ul>

Passive measurement of VSWR with output levels of SMIQ below -30 dBm	<ul style="list-style-type: none"> <li>➤ Settings on SMIQ:             <ul style="list-style-type: none"> <li>- Test level</li> <li>- Frequency far from test frequency, unmodulated</li> </ul> </li> <li>➤ Settings on second signal generator:             <ul style="list-style-type: none"> <li>- Test frequency</li> <li>- Level 10 dBm</li> </ul> </li> <li>➤ Unscrew the VSWR bridge from the DUT and note down the level measured at the analyzer as reference value.</li> <li>➤ Screw on the bridge or directional coupler again and determine the new level at the analyzer.             <ul style="list-style-type: none"> <li>⇒ The voltage ratio of test level to reference level is the output reflection coefficient <math>r</math> of the DUT.</li> <li>The voltage standing wave ratio (VSWR) can be calculated according to the formula                 <math display="block">\text{VSWR} = (1+r)/(1-r)</math> </li> </ul> </li> </ul>
--	--

### 5.3.4.3 Settling Time

Test assembly	Connect the spectrum analyzer (Table 5-1, item 2) to the RF connector of the SMIQ.
Test method	The spectrum analyzer is operated as a fast level meter with a span of 0 Hz. A controller transfers the start and the stop level via the IEC bus. The analyzer is triggered by the positive edge on the EOI line of the IEC bus. When the controller switches over from start to stop level, the settling procedure is displayed on the screen of the storage analyzer.
Preparation of measurement	<ul style="list-style-type: none"> <li>➤ Synchronize the reference frequencies of the SMIQ and the analyzer.</li> <li>➤ Make IEC-bus and RF connections.</li> <li>➤ Apply trigger connection to EOI line (pin 5) of IEC bus.</li> <li>➤ Setting on SMIQ:             <ul style="list-style-type: none"> <li>- Test frequency 1GHz</li> </ul> </li> <li>➤ Settings on storage oscilloscope:             <ul style="list-style-type: none"> <li>- Time base 5 ms/div</li> <li>- Sensitivity according to video output of analyzer</li> </ul> </li> <li>➤ Settings on spectrum analyzer:             <ul style="list-style-type: none"> <li>- Reference level 10 dBm</li> <li>- Amplitude scale 10 dB/div</li> <li>- Resolution bandwidth 300 kHz</li> <li>- Video bandwidth 300 kHz</li> <li>- Span 0 Hz</li> <li>- Sweep time 50 ms,</li> <li>- Triggering externally by the positive edge at 1.5 V.</li> </ul> </li> </ul>
Measurement	<ul style="list-style-type: none"> <li>➤ First send the start and then the stop level from controller.             <ul style="list-style-type: none"> <li>⇒ The level characteristic from the trigger point is displayed on the screen of the externally triggered analyzer.</li> </ul> </li> <li>➤ Repeat the measurement with the start and the stop level interchanged.             <ul style="list-style-type: none"> <li>⇒ Measure the following steps in both directions:</li> </ul> </li> </ul>

Setting	Start level	Stop level	Remarks
CW	-140 dBm	PcW <sub>max</sub>	With mechanical attenuator, in direction of stop level only
CW, FM 10 kHz	PcW <sub>max</sub> -35	PcW <sub>max</sub>	With mechanical attenuator
CW, FM 10 kHz	PcW <sub>min</sub>	PcW <sub>max</sub>	Without mechanical attenuator
AM 30%	Pam <sub>min</sub> -35	Pam <sub>min</sub>	With mechanical attenuator
AM 30%	Pam <sub>min</sub>	PcW <sub>max</sub>	Without mechanical attenuator

QuickBasic program for the controller

```

CLS
iecadresse% = 28
CALL IBFIND("DEV1", generator%)
CALL IBPAD(generator%, iecadrese%)
iecterm% = &HA '
CALL IBEOS(generator%, iecterm% + &H800)
CALL IBWRT(generator%, "FREQ 1GHZ")
DO
  INPUT "Start level in dBm";P1$
  INPUT "Stop level in dBm";P2$
  DO
    CALL IBWRT(generator%, "POW" + P1$ + "dBm")
    PRINT "Level: ";P1$; "dBm"
  DO '
    kbd$ = INKEY$
    LOOP UNTIL LEN(kbd$)
    SWAP P1$, P2$
  LOOP UNTIL kbd$ = CHR$(27) '
  INPUT "Repeat (y/n)"; w$
LOOP UNTIL NOT UCASE$(w$) = "Y"
END

```

IEC/IEEE-bus address of the SMIQ (28)  
 Open DEV1 and obtain access number  
 Set IEC-bus address of DEV1 to 28  
 Set EOS to LINE FEED

Press any key

Exit with ESCAPE

### 5.3.4.4 Non-Interrupting Level Setting (ATTENUATOR MODE FIXED)

- Test equipment                      Spectrum analyzer (Table 5-1, item 2)
- Test setup                            ➤ Connect the analyzer to the RF output of the SMIQ.
- Measurement                        ➤ Settings on SMIQ:  
     - Recommended test frequencies: 5, 100, 1000, 1500, 2200, 3300, 3301, 4400, 5000, 6400 MHz, unmodulated  
     - Level  $P_{cw_{min}}$   
     - Select FIXED in the menu LEVEL/LEVEL ATTENUATOR MODE.
- Settings on analyzer  
     same as for the measurement of level frequency response and linearity
- Note down the level read at the analyzer as reference value.
- Now reduce the level at the SMIQ in steps of 5 dB and measure the deviations from the nominal reduction.
- Settings on SMIQ  
     Level  $P_{cw_{min}}$   
     in the LEVEL/LEVEL ATTENUATOR MODE ELEC menu
- Now reduce the level in steps of 5 dB and measure the deviations from the nominal reduction. Reduce the reference level of the analyzer by 50 dB at  $P_{cw_{min}} -50$  dBm and carry out a calibration of the connections.
- ⇒ The following deviations should not be exceeded:

Attenuation in dB ATT FIXED	Tolerance in dB
5	0.15
10	0.3
15	0.8
20	2.5
Attenuation in dB ATT ELEC	
35	1
70	1.5
80	2.3

### 5.3.4.5 Overvoltage Protection (if provided)

Test equipment	<ul style="list-style-type: none"> <li>- Adjustable DC voltage source (Table 5-1, item 12)</li> <li>- Signal generator (Table 5-1, item 5)</li> <li>- Power amplifier (Table 5-1, item 13)</li> </ul>
Test setup	<ul style="list-style-type: none"> <li>➤ Connect an adjustable DC voltage source to the RF output socket of the SMIQ via a 50 Ω resistor or a signal generator with a subsequent power amplifier with a power output of more than 1 W.</li> </ul>
Measurement	<ul style="list-style-type: none"> <li>➤ Settings on SMIQ:             <ul style="list-style-type: none"> <li>- Frequency 100 MHz, unmodulated</li> <li>- Level -120 dBm</li> </ul> </li> <li>➤ Apply the DC voltage via the 50 Ω resistor.             <ul style="list-style-type: none"> <li>⇒ The overvoltage protection must respond at a voltage &gt; 4 V and &lt; 7 V for both polarities.</li> </ul> </li> <li>➤ Connect the signal generator to the RF output socket of the SMIQ via the power amplifier and apply frequencies of up to <math>RF_{max}</math>. Increase the level at each frequency, starting with 0.1 W.             <ul style="list-style-type: none"> <li>⇒ The overvoltage protection should respond at an RF power of 1 W at the latest.</li> </ul> </li> </ul>

## 5.3.5 Spectral Purity

### 5.3.5.1 Harmonics

Test equipment	Spectrum analyzer (Table 5-1, item 2)
Test setup	Connect the spectrum analyzer to the RF output of the SMIQ. Synchronize reference frequencies of analyzer and DUT.
Recommended settings on the spectrum analyzer	<ul style="list-style-type: none"> <li>➤ Reference level = test level + 3 dB, 10 dB/div.</li> <li>Span 0 Hz,</li> <li>Resolution bandwidth 1 kHz,</li> <li>Video bandwidth 30 Hz,</li> <li>Sample detector</li> </ul>
<b>Note:</b>	<i>These values are typical values that are dependent on the analyzer used. The necessary spacing must be verified prior to the measurement.</i>
Recommended frequencies	300 kHz, 1 MHz, 5 MHz and as from 50 MHz according to Table 5-2
Measurement	<ul style="list-style-type: none"> <li>➤ Settings on SMIQ:             <ul style="list-style-type: none"> <li>- Test frequencies, unmodulated</li> <li>- Level <math>P_{cw_{max}}</math> according to data sheet</li> </ul> </li> <li>➤ Settings on analyzer: ATTENUATOR AUTO LOW DISTORTION</li> <li>➤ First measure the level of the fundamental as a reference. Then find signals at twice and three times the carrier frequency.             <ul style="list-style-type: none"> <li>⇒ The harmonic spacing is the measured level referred to the fundamental (dBc = referred to the carrier).</li> </ul> </li> </ul>

### 5.3.5.2 Subharmonics

Test equipment	Same as for harmonics suppression
Test setup	Same as for harmonics suppression
Recommended frequencies	1501 MHz to 3039 MHz in 10-steps
Measurement	<ul style="list-style-type: none"> <li>➤ First the level of the fundamental is measured as reference, then a signal is searched for at the 0.5*test frequency and 1.5*test frequency.</li> <li>⇒ The subharmonic spacing is the measured level referred to the reference level (dBc = referred to the carrier).</li> </ul>

### 5.3.5.3 Nonharmonics

Test equipment	Same as for harmonics
Test setup	Same as for harmonics
Measurement	<ul style="list-style-type: none"> <li>➤ Setting at the analyzer ATTENUATOR AUTO LOW NOISE</li> <li>➤ First the level is measured at the test frequency as reference, then a signal is searched for at the analyzer frequency.</li> <li>⇒ The nonharmonic spacing is the measured level referred to the reference level (dBc = referred to the carrier).</li> </ul>

**Note:** *Some of the nonharmonics suppression values to be measured are out of the analyzer specifications. In case of doubt, the measurement should be repeated with a 3 dB attenuator at the analyzer input. If the nonharmonic spacing changes, the nonharmonic is from the analyzer.*

#### Recommended settings and sampling frequencies:

Nonharmonics of step synthesis at test level  $P_{cw_{min}}$ , unmodulated

Setting on SMIQ Frequency in MHz	Analyzer frequency in MHz	Corresponds to spacing df in kHz
831.0	831.6896	689.6
832.7	833.3993	699.3
1044.5	1045.0988	598.8
1043.0	1043.5917	591.7
1139.6	1140.1181	518.1
1141.0	1141.5235	523.5
1457.5	1458.4174	917.4
1349.6	1350.5345	934.5
1444.0	1444.8264	826.4
1446.0	1446.8403	840.3
1430.5	1431.2519	751.9
1434.1	1434.8634	763.4



Nonharmonics of summing circuit at test level  $P_{cw_{min}}$ , unmodulated

Setting on SMIQ Frequency in MHz	Analyzer frequency in MHz	Corresponds to spacing df in Hz
1412.9	1413.2	300.0k
1305.4	1305.7	300.0k
1197.9	1198.2	300.0k
1090.4	1090.7	300.0k
838.25	838.3676	117.6k
380	380.4255	425.5k
1495.59	1511.18	15.59M
1354.0625	1368.3192	14.2567M
1354.0625	1382.5758	28.5133M

Nonharmonics IQMOD at test level  $P_{cw_{min}}$ , unmodulated

Setting on SMIQ Frequency in MHz	Analyzer frequency in MHz
451	300, 600, 1200, 2400, 3000
449.9	600, 1200, 2400
225	600, 1200, 2400
70.0	600, 1200, 2400

Nonharmonics of output mixer IQMOD at test level  $P_{cw_{max}}$ , unmodulated

Setting on SMIQ Frequency in MHz	Analyzer frequency in MHz
449	1053, 1951, 2849
449.9	1050.3, 600.4
225	1725
70.0	2190

Nonharmonics of IQ synthesis at test level  $P_{vm_{min}}$ , VM at max. level

Setting on SMIQ Frequency in MHz	Analyzer frequency in MHz
751	600
901	900
751	1051, 1351
1450	1750, 2050, 1150, 850
1800	2100
1801	1501, 3002
2150	1850, 2450
2500	2200
2501	2201
2900	2600, 2300
3200	2900, 3500
595	305
1	299
149	151
524	752, 452
401	698

Nonharmonics of output mixer IQMOD at test level  $P_{vm_{max}}$ , VM at max. level

Setting on SMIQ Frequency in MHz	Analyzer frequency in MHz
580	660
749.99	900.02

Nonharmonics of module E6GHZ at test level  $P_{cw_{min}}$ , unmodulated

Setting on SMIQ Frequency in MHz	Analyzer frequency in MHz
3301, 3350, 50 MHz steps up to 6400 MHz	1200, 2400, 3600
Same as above	+300, 600 MHz from carrier
Same as above	+900 MHz from carrier
3301, 3350, 50 MHz steps up to 5100 MHz	$0.5*(f+900 \text{ MHz})$
5101, 5150, 50 MHz steps up to 6400 MHz	$0.5*(f-900 \text{ MHz})$

Non-systematic nonharmonics

Measurement

- Settings on SMIQ:
  - Test frequencies: 93, 520, 749, 751, 1799, 2200, 2499, 2501, 3300, 3301, 4199, 4400, 5099, 5101, 5999, 6001, 6400 MHz
  - Test levels  $P_{cw_{min}}$  unmodulated and  $P_{vm_{min}}$  with vector modulation at max. level
- Recommended settings on analyzer:
  - Sample detector
  - Frequency far from the carrier:
    - REF ATTEN AUTO LOW NOISE
    - Resolution bandwidth 30 kHz
    - Video bandwidth 1 kHz
    - Span 10 MHz
  - Frequency at 50 kHz to 1 MHz from the carrier:
    - Resolution bandwidth 1 kHz
    - Video bandwidth 1 kHz
    - Average over at least 3 sweeps.

### 5.3.5.4 Broadband Noise

Test assembly	Connect spectrum analyzer to RF socket of the SMIQ.
Test method	Operate the spectrum analyzer in the CHANNEL POWER mode. Set SPAN to 400 kHz, channel bandwidth to 350 kHz, detector to SAMPLE, attenuator to LOW NOISE, and PLL bandwidth with COUPLING/MAIN PLL BANDWIDTH to LOW. For reference level measurement, set the center frequency of the analyzer to the test frequency, set the reference level to the test level, and read the channel power. Then measure the reference level by shifting the center frequency of the analyzer by the desired offset (for example 5 MHz). The channel power now displayed must be converted to 1 Hz bandwidth and referred to the carrier power. By performing a measurement without input level, the analyzer's inherent noise can be determined and subtracted if necessary.
Measurement	<ul style="list-style-type: none"> <li>➤ Determine the channel power with the center frequency of the analyzer set to the test frequency and note it down as <math>P_{ref}</math>.</li> <li>➤ Increase the center frequency by the offset (5 MHz).</li> <li>➤ Inhibit the switching of the attenuator with REF RF ATTEN MANUAL without entering a value so that the input mixer is not overdriven.</li> <li>➤ Lower the reference level of the analyzer by 20 dB, read the new channel power <math>P_{noise}</math> and note it down.</li> <li>➤ Minimize the output level on the SMIQ by means of RF OFF, read the channel power <math>P_{res}</math> and note it down.</li> </ul>
Evaluation	<ul style="list-style-type: none"> <li>➤ If the power <math>P_{res}</math> is lower than <math>P_{noise}</math> by more than 0.41 dB and less than 10 dB, the inherent noise power of the analyzer can be subtracted. To this effect, convert the two power values into mW according to the formula <math>P_{mW} = 10^{(P_{dBm}/10)}</math>, then subtract <math>P_{res}</math> from <math>P_{noise}</math>. Reconvert the corrected power into dBm according to the formula <math>P_{dBm} = 10 \cdot \log_{10}(P_{mW})</math>.</li> <li>➤ If the power <math>P_{res}</math> is less than 0.41 dB below the power <math>P_{noise}</math>, the analyzer resolution is not sufficient for a precise measurement. The true result is in such case certainly more than 10 dB below the measured value. If <math>P_{res}</math> is more than 10 dB below <math>P_{noise}</math>, <math>P_{noise}</math> need not be corrected since the noise component of the analyzer is negligible.</li> <li>➤ Convert the power <math>P_{noise}</math> to 1 Hz bandwidth according to the formula <math>P_{1Hz} = P_{ch} - (10 \cdot \log_{10}(\text{channel bandwidth}))</math>. <ul style="list-style-type: none"> <li>⇒ The difference between the (possibly corrected) power <math>P_{noise}</math> in dBm and the power <math>P_{ref}</math> in dBm is the broadband noise floor in dBc.</li> </ul> </li> </ul>
Recommended test frequencies	See Table 5-2, at least * frequencies.
Recommended test levels	$P_{cw_{min}}$ with unmodulated carrier and $P_{vm_{min}}$ with vector modulation at full-scale level (0.5 V DC at I or Q input)

### 5.3.5.5 SSB Phase Noise

Test assembly	See section "Test Assemblies"
Test method	The two signal generators are set to the test frequency and synchronized with a phase offset of 90° (phase quadrature). Mixing to 0 Hz suppresses the RF carrier, and due to the phase quadrature the mixer supplies a voltage corresponding to the phase difference between the input signals. This is measured by the LF spectrum analyzer and can be converted into SSB phase noise.
Measurement	<ul style="list-style-type: none"> <li>➤ Set the levels of the two signals generators in accordance with the specifications of the mixer used (unmodulated or vector modulation with max. level).</li> <li>➤ For calibration, reduce the level of the DUT by 40 dB and detune one signal generator by 20 kHz. Check the signal for harmonics; the 2nd and 3rd harmonic should be more than 30 dB below the fundamental. Measure the reference value at 20 kHz at the analyzer and note it down.</li> <li>➤ Set the detuned signal generator to the previous frequency and set the signal generators for phase quadrature. To this end, raise the level of the DUT to the previous level and call PHASE in the UTILITIES menu. Observe the output voltage of the mixer on the oscilloscope and vary the phase until the voltage becomes 0.</li> <li>➤ Read the noise voltage, normalized to a bandwidth of 1 Hz (noise level) from the analyzer.</li> </ul>
Evaluation	<ul style="list-style-type: none"> <li>➤ Determine the difference relative to the reference level and add to the value found 6 dB for the second sideband measured (correlated) and 40 dB for level switchover. If the S/N ratio of the second signal generator is not at least 10 dB better than that of the DUT, the noise component of the reference signal generator must be determined and subtracted as well. ⇒ The corrected S/N ratio is the wanted measured value.</li> </ul> <p><b>Example:</b> <i>The measured reference level is assumed to be 12 dBm. A noise level of -78 dBm (1 Hz) is determined at 20 kHz. The difference is 90 dB, plus the correction for the second sideband (6 dB) and level switchover (40 dB), yielding an S/N ratio of -136 dB or a noise level of -136 dBc (dB referred to the carrier power). If two identical signal generators have been used, the result must be reduced by 3 dB for the (uncorrelated) noise power of the reference signal generator.</i></p> <p><i>The final result is then -139 dBc.</i></p>

### 5.3.5.6 Residual FM

**Note:** *The measurement of SSB phase noise usually makes a measurement of residual FM superfluous as it is more sensitive.*

Test assembly See section "Test Assemblies", standard test assembly for analog modulations

Measurement

- Settings on SMIQ:
  - Frequency 1 GHz
  - Level  $P_{cw_{max}}$ , unmodulated
- Setting on analyzer:
  - Demodulation FM, rms value
- Determine the residual FM with ITU-T(CCITT) filtering and with a test bandwidth of 30 Hz to 23 kHz.

### 5.3.5.7 Residual AM

Test assembly Same as above.

Measurement Same as above, but with AM demodulation.

Test frequencies \*-values of Table 5-2 as from 1 MHz.

### 5.3.6 Sweep

Test equipment DC voltmeter (Table 5-1, item 19)

Test setup

- Connect the voltmeter to the X-AXIS, MARKER or BLANK socket of the SMIQ.

Measurement

- Settings on SMIQ:
  - Set any sweep with 10 steps. Define a marker in the sweep range.
- Select LONG as SWEEP BLANK TIME.
- Select all steps in the STEP mode and measure the voltage at the sockets X-AXIS and MARKER.
- The voltage at X-AXIS should rise proportionally to the sweep steps from 0 to 10 V. Tolerance:  $\pm 5\%$   $\pm 30$  mV.
- The voltage at MARKER should go "high" when the marker step is selected, otherwise it should remain "low".
- Perform a SINGLE sweep to check the BLANK output. After the end of the sweep, the voltage at the BLANK output should go "high".

It is sufficient to perform the test in one sweep mode.

### 5.3.7 Internal Modulation Generator

Test equipment	Audio analyzer (Table 5-1, item 14)
Test setup	<ul style="list-style-type: none"> <li>➤ Connect the audio analyzer to the LF socket of the SMIQ. For frequency measurements above 100 kHz, connect the spectrum analyzer.</li> </ul>
Measurement of frequency settings and distortion	<ul style="list-style-type: none"> <li>➤ Settings on SMIQ:               <ul style="list-style-type: none"> <li>- LF OUTPUT menu:</li> <li>SOURCE LFGEN</li> <li>VOLTAGE 1 V</li> <li>Vary LFGEN FREQUENCY from 0.1 Hz to 1 MHz.</li> </ul> </li> <li>➤ Read the actual frequency from the audio or spectrum analyzer (Marker function SIGNAL COUNT).</li> <li>➤ Read the distortion from the audio analyzer.</li> </ul>
Recommended test frequencies for frequency settings	1 kHz, 33.3333 kHz, 1 MHz
Recommended test frequencies for distortion	20 Hz, 300 Hz, 1 kHz, 3 kHz, 10 kHz, 30 kHz, 100 kHz
Measurement of the level	<ul style="list-style-type: none"> <li>➤ Settings on SMIQ:               <ul style="list-style-type: none"> <li>- LF OUTPUT menu:</li> <li>Set LFGEN2 FREQUENCY to 1 kHz.</li> <li>- Vary VOLTAGE from 1 mV to 4 V.</li> </ul> </li> <li>➤ Measure the output level with the audio analyzer.</li> </ul>
Recommended settings	3 mV, 10 mV, 30 mV, 100 mV, 300 mV, 1 V, 2 V, 4 V
<b>Frequency response</b>	
Test equipment	AC voltmeter (Table 5-1, item 19)
Test setup	<ul style="list-style-type: none"> <li>➤ Connect the AC voltmeter to the LF socket of the SMIQ.</li> </ul>
Measurement	<ul style="list-style-type: none"> <li>➤ Settings on SMIQ:               <ul style="list-style-type: none"> <li>- LF OUTPUT menu:</li> <li>SOURCE LFGEN</li> <li>Vary LFGEN FREQUENCY from 10 Hz to 1 MHz.</li> <li>Recommendation: logarithmic with 4 steps/decade.</li> </ul> </li> <li>➤ Measure the output level.               <ul style="list-style-type: none"> <li>⇒ The frequency response is the difference between the highest and the lowest level.</li> </ul> </li> </ul>

**Note:** *The required settling time is a pure computer time and need therefore not be measured.*

### 5.3.8 Vector Modulation

#### 5.3.8.1 Input Impedance (VSWR)

Test equipment	Test assembly for output impedance
Test setup	<ul style="list-style-type: none"> <li>➤ Connect the test port to the I or Q input instead of the RF output.</li> </ul>
Measurement	<ul style="list-style-type: none"> <li>➤ Settings on SMIQ:             <ul style="list-style-type: none"> <li>- Level 0 dBm</li> <li>- Carrier frequency 900 MHz</li> <li>- Switch on vector modulation.</li> </ul> </li> <li>➤ Settings on signal generator:             <ul style="list-style-type: none"> <li>- Level 10 dBm</li> <li>- Carrier frequency 5, 10 and 30 MHz</li> </ul> </li> <li>➤ Screw the VSWR bridge off and measure the level as reference level.</li> <li>➤ Connect the VSWR bridge to the I input and measure the level again.             <ul style="list-style-type: none"> <li>⇒ The voltage ratio of test level to reference level is the output reflection coefficient <math>r</math> of the DUT.</li> </ul> </li> <li>➤ From this, the voltage standing wave ratio (VSWR) can be calculated as follows:             <math display="block">\text{VSWR} = (1+r)/(1-r)</math> </li> <li>➤ Repeat the measurement for the Q input.</li> </ul>

#### 5.3.8.2 Maximum Level

Test equipment	<ul style="list-style-type: none"> <li>- Power meter (Table 5-1, item 8)</li> <li>- DC voltage source (Table 5-1, item 12)</li> </ul>
Test setup	<ul style="list-style-type: none"> <li>➤ Connect the power meter (Table 5-1, item 8) to the RF output socket.</li> <li>➤ Connect the DC voltage source to the I or Q input.</li> </ul>
Measurement	<ul style="list-style-type: none"> <li>➤ Settings on SMIQ:             <ul style="list-style-type: none"> <li>- Level 0 dBm</li> <li>- Carrier frequency 900 MHz</li> </ul> </li> <li>➤ Measure the level without modulation as reference level.</li> <li>➤ Select STATE ON in the menu VECTOR MOD. Set the DC voltage source to 0.500 V. Measure the level again.             <ul style="list-style-type: none"> <li>⇒ The level difference should be within the permissible tolerance specified in the data sheet.</li> </ul> </li> </ul>

### 5.3.8.3 Error Vector

Test assembly	See section "Test Assemblies", vector modulation
Measurement	<p>Instead of a static measurement, an equivalent dynamic measurement with a low symbol rate is carried out.</p> <ul style="list-style-type: none"> <li>➤ Settings on SMIQ:             <ul style="list-style-type: none"> <li>- Level 0 dBm</li> <li>- Select STATE ON in the menu VECTOR MOD.</li> </ul> </li> <li>➤ Generate a modulation signal on the ARB generator using the controller and the simulation program:             <ul style="list-style-type: none"> <li>- Modulation 16QAM</li> <li>- No coding</li> <li>- SQR COS filter with <math>\alpha = 0.5</math></li> <li>- PRBS-9 data sequence</li> <li>- Pulse width and oversampling 32</li> <li>- Length 100 symbols</li> <li>- Symbol clock 10 kHz</li> </ul> </li> <li>➤ Check if the channels on the ARB generator are equal and adjust if necessary.</li> <li>➤ Make the corresponding settings on the demodulator. Synchronize to a bit sequence, starting with the 9th symbol, 12 bits long, result length 80 symbols.</li> <li>➤ Vary the carrier frequency from 5 MHz to <math>RF_{max}</math>. For recommended setting values see Table 5-2, at least * frequencies.</li> <li>➤ Measure the error vector magnitude (peak and rms) on the demodulator.</li> </ul>

### 5.3.8.4 Modulation Frequency Response

Test equipment	<ul style="list-style-type: none"> <li>- Spectrum analyzer (Table 5-1, item 2)</li> <li>- Signal generator (Table 5-1, item 5)</li> </ul>
Test setup	<ul style="list-style-type: none"> <li>➤ Connect the RF output of the SMIQ to the spectrum analyzer, connect the signal generator to the I input of the SMIQ.</li> </ul>
Test method	By applying a sinewave AC voltage to the I (or Q) input, an amplitude modulation with a suppressed carrier is generated. The modulation frequency response is determined by measuring the sidebands as a function of the frequency of the applied AC voltage.



- Measurement
- Settings on SMIQ:
    - Test level 0 dBm, test frequency > 100 MHz
    - Select STATE ON in the menu VECTOR MOD.
  - Setting on signal generator:
    - Level 0.5 V ( $V_{peak}$ ) corresponding to 4 dBm
  - Settings on analyzer:
    - Center frequency = test frequency, span 30 kHz, RBW 10 kHz,
    - Reference level = test level +6 dB
    - Scale 2 dB/div
  - Vary the frequency from 1 MHz to 30 MHz on the signal generator and observe the modulation sidebands on the analyzer using an appropriate span (CENTER FREQ = test frequency +/- modulation frequency).
    - ⇒ The result level for a sideband frequency is the average value of the left and the right sideband level.
  - For evaluation, determine the difference between the modulation sidebands.
    - ⇒ The modulation frequency response is the difference between the highest and the lowest sideband.
  - Settings on SMIQ:
    - Test level 0 dBm,
    - Test frequencies 751 MHz, 950 MHz, 1799 MHz, 1801 MHz, 2499 MHz, 2501 MHz, 3299 MHz, 3301 MHz, 4199 MHz, 4201 MHz, 5099 MHz, 6001 MHz, 6400 MHz.
    - Test these frequencies for compliance with the 3 dB limit by performing a measurement at 1 MHz, 15 MHz and 30 MHz on the signal generator.

### 5.3.8.5 Residual Carrier and Leakage

- Test equipment                      Spectrum analyzer (Table 5-1, item 2)
- Test setup
- Connect the spectrum analyzer to the RF output of the SMIQ.
- Measurement
- Settings on SMIQ:
    - Test level  $P_{vm_{max}}$ ,
    - Test frequencies: 395, 600, 936, 1250, 1801, (2200), 3301, 5099, 5501, (4400), 6400 MHz, unmodulated
    - Select STATE OFF in the menu VECTOR MOD/STATE.
  - Settings on analyzer:
    - Center frequency = test frequency, span 1 MHz
    - Reference level = test level
    - Scale 10 dB/div
  - First measure the unmodulated level as a reference.
  - Then switch on vector modulation with open inputs (STATE ON) and measure the residual carrier.
    - ⇒ The residual carrier in dBc is the level of the residual signal found referred to the output signal of the DUT without modulation (dBc = referred to the carrier).
  - Set IMPAIRMENT STATE ON and LEAKAGE 10% on the SMIQ.
    - ⇒ The residual carrier should increase to 10% (-20 dBc).

### 5.3.8.6 I/Q Imbalance

#### Measurement of imbalance

- |                |   |
|----------------|---|
| Test equipment | <ul style="list-style-type: none"> <li>- Spectrum analyzer (Table 5-1, item 2)</li> <li>- Adjustable DC voltage source (Table 5-1, item 12)</li> </ul>  |
| Test setup     | <ul style="list-style-type: none"> <li>➤ Connect the spectrum analyzer to the RF output of the SMIQ.</li> <li>➤ Connect the DC voltage source to the I or the Q input.</li> </ul>   |
| Measurement    | <ul style="list-style-type: none"> <li>➤ Settings on SMIQ:             <ul style="list-style-type: none"> <li>- Test frequency 900 MHz</li> <li>- Test level 0 dBm</li> <li>- Select STATE ON in the menu VECTOR MOD.</li> </ul> </li> <li>➤ Settings on analyzer:             <ul style="list-style-type: none"> <li>- Center frequency = test frequency, span 1 MHz</li> <li>- Reference level = test level +3 dB</li> <li>- Scale 1 dB/div</li> </ul> </li> <li>➤ First measure the undistorted level as a reference. To this end, apply a DC voltage of 0.500 V to the I and then to the Q input and note down the corresponding RF levels as reference levels. In the menu VECTOR MOD/IMPAIRMENT STATE, select ON and IMBALANCE 10%. Repeat the level measurements.             <ul style="list-style-type: none"> <li>⇒ The I level should increase by the set imbalance, the Q level decrease by the inverse ratio. With 10%, the I level should increase to 1.1 times, the Q level decrease to 1/1.1 times the original value, i.e. the Q level should be reduced to 0.909 times the original value (corresponding to <math>\pm 0.83</math> dB).</li> </ul> </li> </ul> |

#### Measurement quadrature error

- |               |  |
|---------------|--|
| Test assembly | See section "Test Assemblies", vector modulation   |
| Measurement   | <ul style="list-style-type: none"> <li>➤ Settings on SMIQ:             <ul style="list-style-type: none"> <li>- Level 0 dBm</li> <li>- Test frequency 900 MHz</li> <li>- In the menu VECTOR MOD, select STATE ON, IMPAIRMENT STATE OFF, QUADRATURE ERROR 10°.</li> </ul> </li> <li>➤ Generate a modulation signal using the controller and the simulation program:             <ul style="list-style-type: none"> <li>- Modulation 16QAM</li> <li>- No coding</li> <li>- SQR filter with <math>\alpha = 0.5</math></li> <li>- PRBS-9 data sequence</li> <li>- Pulse width and oversampling 32</li> <li>- Length 100 symbols</li> <li>- Symbol clock 10 kHz</li> </ul> </li> <li>➤ Make the corresponding settings on the demodulator. Synchronize to a bit sequence, starting with the 9th symbol, 12 bits long, result length 80 symbols. <b>Caution: the mapping of DUT and demodulator must be in agreement!</b></li> <li>➤ Select the vector representation on the demodulator.             <ul style="list-style-type: none"> <li>⇒ The symbols should be located in a square grid.</li> </ul> </li> <li>➤ Select IMPAIRMENT STATE ON on the SMIQ.             <ul style="list-style-type: none"> <li>⇒ The symbols must no longer be arranged at right angles; the Y axis should be inclined towards the left by 10°, with a setting of -10° it should be inclined towards the right.</li> </ul> </li> </ul> |

### 5.3.8.7 Level Control POW RAMP

Test equipment	<ul style="list-style-type: none"> <li>- Spectrum analyzer (Table 5-1, item 2)</li> <li>- 2 adjustable DC voltage sources (Table 5-1, item 12)</li> <li>- Function generator (Table 5-1, item 18 or 24)</li> <li>- Digital storage oscilloscope (Table 5-1, item 3)</li> </ul>
Test setup	<ul style="list-style-type: none"> <li>➤ Connect the spectrum analyzer to the RF output of the SMIQ.</li> <li>➤ Connect the 1st DC voltage source to the I input with 0.50 V.</li> <li>➤ Connect the 2nd DC voltage source to the POW RAMP input.</li> </ul>
Measurement	<ul style="list-style-type: none"> <li>➤ Settings on SMIQ: <ul style="list-style-type: none"> <li>- Test frequency 900 MHz</li> <li>- Level 0 dBm</li> <li>- Select STATE ON in the menu VECTOR MOD.</li> </ul> </li> <li>➤ Settings on analyzer: <ul style="list-style-type: none"> <li>- Center frequency = test frequency, span 1 MHz</li> <li>- Reference level = test level</li> <li>- Scale 10 dB/div</li> </ul> </li> <li>➤ First measure the non-attenuated level with 1.00 V at the POW RAMP input as a reference. Then reduce the voltage to 0.100 V and measure the level again. <ul style="list-style-type: none"> <li>⇒ A value 20 dB lower is now expected. The attenuation error at -20 dB is the deviation of this level from the expected value.</li> </ul> </li> <li>➤ Reduce the voltage to 0.00 V and determine the residual level. <ul style="list-style-type: none"> <li>⇒ The on/off ratio is the residual level referred to the reference level at 1 V.</li> </ul> </li> </ul>
Test setup	<ul style="list-style-type: none"> <li>➤ To measure the dynamic characteristics, connect a function generator to the POW RAMP input.</li> <li>➤ Connect one channel of the storage oscilloscope to the video output of the analyzer and the other one to the input signal from the function generator.</li> </ul>
Measurement	<ul style="list-style-type: none"> <li>➤ Setting on function generator: <ul style="list-style-type: none"> <li>- Squarewave signal with offset, lower level 0.1 V, upper level 1.0 V, frequency 100 kHz</li> </ul> </li> <li>➤ Settings on analyzer: <ul style="list-style-type: none"> <li>- Center frequency = test frequency, span 0 Hz</li> <li>- Reference level = test level</li> <li>- Scale 10 dB/div</li> <li>- Resolution and video bandwidth 10 MHz</li> </ul> </li> <li>➤ Trigger on the input signal on the oscilloscope. Two offset squarewave signals appear on the screen which can be evaluated after a delay (&lt;1.5 s) and rise/fall time. <ul style="list-style-type: none"> <li>⇒ Rise time = time between 10% and 90% of RF amplitude</li> <li>    Fall time = time between 90% and 10% of RF amplitude</li> <li>    Delay = time between 50% of input amplitude and 50% of RF amplitude</li> </ul> </li> <li>• On the FSIQ the video signal is always logarithmic with 9 mV/dB and independent of the video bandwidth. The 90% level is thus approx. 8 mV (0.9 dB) below the upper level, the 10% level approx. 50 mV (5.4 dB) above the lower level (because of the start at -20 dB, 10% of the rise is at -14.4 dB).</li> </ul>

### 5.3.9 Amplitude Modulation

#### 5.3.9.1 Modulation Depth Setting

Test assembly	See section "Test Assemblies", standard test assembly for analog modulations
Measurement	<ul style="list-style-type: none"> <li>➤ Settings on SMIQ:             <ul style="list-style-type: none"> <li>- Level 0 dBm</li> <li>- Select INT in the menu ANALOG MOD/AM/AM SOURCE INT, Modulation depth 0.1% to 80% Modulation frequency 1 kHz</li> </ul> </li> <li>➤ Vary the carrier frequency from 5 MHz to <math>RF_{max}</math>. For recommended setting values see Table 5-2, at least * frequencies.</li> <li>➤ Read the modulation depth from the modulation analyzer.</li> </ul>
Recommended settings	<ul style="list-style-type: none"> <li>➤ Resolution of the setting Measurement at <math>f_{mod} = 1</math> kHz, RF 150 MHz, test level <math>P_{am_{min}} + 3</math> dBm of <math>m = 10\%</math> to <math>96\%</math> in 10-steps.</li> <li>➤ RF frequency response at <math>f_{mod} = 1</math> kHz, <math>m = 80\%</math>, test level <math>P_{am_{max}}</math>, test frequencies 1 MHz, 5 MHz, more in Table 5-2, *-frequencies.</li> </ul>

#### 5.3.9.2 AM Distortion

Test assembly	See section "Test Assemblies", standard test assembly for analog modulations
Measurement	<ul style="list-style-type: none"> <li>➤ Settings on SMIQ:             <ul style="list-style-type: none"> <li>- Level <math>P_{am_{min}}</math></li> <li>- Select INT in the menu ANALOG MOD/AM/AM SOURCE INT</li> <li>- Modulation depth 30%</li> <li>- Modulation frequency 1 kHz</li> </ul> </li> <li>➤ Vary the carrier frequency from 5 MHz to <math>RF_{max}</math>. For recommended setting values see Table 5-2, at least * frequencies.</li> <li>➤ Read the distortion from the modulation analyzer.</li> <li>➤ Repeat the measurement with <math>P_{am_{max}}</math> and AM 80%.</li> </ul>

#### 5.3.9.3 AM Frequency Response

Test assembly	See section "Test Assemblies", standard test assembly for analog modulations with audio analyzer
Measurement	<ul style="list-style-type: none"> <li>➤ Settings on SMIQ:             <ul style="list-style-type: none"> <li>- Level <math>P_{am_{min}} + 3</math> dBm</li> <li>- Select EXT1 in the menu ANALOG MOD/AM/AM SOURCE EXT.</li> <li>- Modulation depth 60%</li> </ul> </li> <li>➤ Vary the carrier frequency from 5 MHz to <math>RF_{max}</math>. Recommended test frequencies: 5, 150, 1500, 1501, (2200), 2500, 3300, 3301, 4199, 4201, (4400), 5099, 5101, 5999, 6001, 6400 MHz..</li> <li>➤ Setting on audio analyzer:             <ul style="list-style-type: none"> <li>- Generator level 1 V (<math>V_{peak}</math>).</li> </ul> </li> <li>➤ Vary the generator frequency to determine the modulation frequency response.             <ul style="list-style-type: none"> <li>⇒ The modulation frequency response is the difference between the greatest and the smallest modulation depth.</li> </ul> </li> <li>➤ Repeat the measurement with the internal modulation generator with the setting INT in the menu ANALOG MOD/AM/AM SOURCE INT.</li> </ul>

### 5.3.9.4 Residual PhiM with AM

Test assembly	See section "Test Assemblies", standard test assembly for analog modulations
Measurement	<ul style="list-style-type: none"><li>➤ Settings on SMIQ:<ul style="list-style-type: none"><li>- Level 0 dBm</li><li>- Select INT in the menu ANALOG MOD/AM/AM SOURCE INT.</li><li>- Modulation depth 30%</li><li>- Modulation frequency 1 kHz</li></ul></li><li>➤ Vary the carrier frequency from 5 MHz to <math>RF_{max}</math>. For recommended setting values see Table 5-2, at least * frequencies.</li><li>➤ Measure the resulting phase modulation on the modulation analyzer with a 3 kHz lowpass filter and peak detection.</li></ul>

### 5.3.9.5 Level Monitoring at Input EXT1

Test assembly	See section "Test Assemblies", standard test assembly for analog modulations with audio analyzer
Test setup	<ul style="list-style-type: none"><li>➤ Connect the generator output of the audio analyzer to the external modulation input EXT1.</li></ul>
Measurement	<ul style="list-style-type: none"><li>➤ Settings on SMIQ:<ul style="list-style-type: none"><li>- Select EXT1 in the menu ANALOG MOD/AM/AM SOURCE EXT.</li><li>⇒ There must be no error message if the input level is correct.</li><li>⇒ An error message must be displayed when the deviation attains the value given in the data sheet.</li></ul></li></ul>

### 5.3.10 Broadband Amplitude Modulation

Test equipment	<ul style="list-style-type: none"> <li>- Spectrum analyzer (Table 5-1, item 2)</li> <li>- Signal generator (Table 5-1, item 5)</li> </ul>
Test setup	<ul style="list-style-type: none"> <li>➤ Connect the RF output of the SMIQ to the spectrum analyzer, connect the signal generator to the I (broadband AM) input of the SMIQ.</li> </ul>
Note	<ul style="list-style-type: none"> <li>➤ If the measurement of the modulation frequency response has been successfully performed for vector modulation, only a functional test is required here.</li> </ul>
Measurement	<ul style="list-style-type: none"> <li>➤ Settings on SMIQ:             <ul style="list-style-type: none"> <li>- Test level 0 dBm, test frequency &gt; 30.3 MHz</li> <li>- Select STATE ON in the menu ANALOG MOD/BB-AM.</li> </ul> </li> <li>➤ Setting on signal generator:             <ul style="list-style-type: none"> <li>- Level 0.20 V (V<sub>peak</sub>) corresponding to -4 dBm for a modulation depth of 80%</li> </ul> </li> <li>➤ <b>Functional test:</b> <p>Vary the frequency from 1 MHz to 30 MHz on the signal generator and measure the sidebands referred to the carrier at SPAN 3 MHz. They should be 8 +/- 1.5 dB below the carrier level.</p> <p>Repeat the measurement at a frequency of 30 MHz on the signal generator and SPAN 70 MHz on the analyzer. The sidebands should now be 8 +/-4.5 dB below the carrier level.</p> </li> <li>➤ <b>Complete measurement:</b> <p>Setting on analyzer and measurement as for vector modulation, modulation frequency response, but the level is first to be measured as reference at the test frequency.</p> </li> <li>➤ Since the sidebands have an offset of m/2 from the carrier, an offset of -6 dB corresponds to 100% AM.             <ul style="list-style-type: none"> <li>⇒ The modulation depth is calculated with the formula  <math display="block">m = 2 \cdot 10^{(\text{sideband offset}/20)}</math> </li> <li>⇒ The frequency response is the difference between the greatest and the smallest modulation depth.</li> </ul> </li> </ul>

### 5.3.11 Pulse Modulation

#### 5.3.11.1 ON/OFF Ratio

Test equipment	<ul style="list-style-type: none"> <li>- Spectrum analyzer (Table 5-1, item 2)</li> <li>- Pulse generator (Table 5-1, item 17)</li> </ul>
Test setup	<ul style="list-style-type: none"> <li>➤ To determine the ON/OFF ratio, connect the spectrum analyzer to the RF output socket of the SMIQ and the pulse generator to the PULSE socket on the rear of the SMIQ.</li> </ul>
Measurement	<ul style="list-style-type: none"> <li>➤ Setting on SMIQ:             <ul style="list-style-type: none"> <li>- Select SOURCE EXT in the menu ANALOG MOD/PULSE.</li> </ul> </li> <li>➤ Determine the output level of the SMIQ at various carrier frequencies with a "high" and a "low" signal applied.             <ul style="list-style-type: none"> <li>⇒ The difference between the output level with a "high" signal applied and that with a "low" signal applied is the ON/OFF ratio.</li> </ul> </li> </ul>
Recommended test frequencies	400 MHz, 1 GHz, 2.2 GHz, 3.3 GHz, 4.4 GHz, 6.4 GHz
Recommended test level	P <sub>cw</sub> <sub>max</sub>

### 5.3.11.2 Dynamic Characteristics

Test assembly	See section "Test Assemblies", test assembly for pulse modulation
Measurement	<ul style="list-style-type: none"> <li>➤ On the dual-trace oscilloscope, simultaneously display the input signal from the pulse generator and the (downconverted) output signal with triggering on the input signal.</li> <li>➤ Setting on pulse generator: <ul style="list-style-type: none"> <li>- Squarewave pulse sequence with a frequency of approx. 100 kHz, TTL level</li> </ul> </li> <li>➤ Setting on SMIQ: <ul style="list-style-type: none"> <li>- Pulse modulation, level depending on mixer used</li> </ul> </li> <li>➤ Vary the carrier frequency from 5 MHz to <math>RF_{max}</math>. For recommended setting values see Table 5-2, at least * frequencies.</li> <li>➤ For carrier frequencies &gt; 50 MHz, use mixer and set an IF of approx. 50 MHz with the auxiliary generator.</li> <li>➤ Evaluate the pulse-modulated RF signal on the oscilloscope. <ul style="list-style-type: none"> <li>⇨ Rise time = time between 10% and 90% of RF amplitude</li> <li>    Fall time = time between 90% and 10% of RF amplitude</li> <li>    Pulse delay = time between 50% of input pulse amplitude and 50% of RF amplitude</li> </ul> </li> </ul>

### 5.3.12 Frequency Modulation (Option SM-B5)

#### 5.3.12.1 FM Deviation Setting

Test assembly	See section "Test Assemblies", standard test assembly for analog modulations
Measurement	<ul style="list-style-type: none"> <li>➤ Settings on SMIQ: <ul style="list-style-type: none"> <li>- RF 500 MHz</li> <li>- Level 0 dBm</li> <li>- Select INT in the menu ANALOG MOD/FM/FM1 SOURCE.</li> <li>- Modulation frequency 1 kHz</li> <li>- Recommended test deviations 300 Hz, 1, 3, 10, 30, 100, 250, 500 kHz</li> </ul> </li> <li>➤ Read the FM deviation from the modulation analyzer.</li> <li>➤ Repeat test at a deviation of 50 kHz and carrier frequencies of 150, 300, 600, 1200, 2200, 3500, 4400, 5600, 6400 MHz.</li> </ul>

#### 5.3.12.2 FM Distortion

Test assembly	See section "Test Assemblies", standard test assembly for analog modulations
Measurement	<ul style="list-style-type: none"> <li>➤ Settings on SMIQ: <ul style="list-style-type: none"> <li>- Carrier frequencies 100, 1200 and 3301 MHz</li> <li>- Half maximum deviation each</li> <li>- Level 0 dBm</li> <li>- Select INT in the menu ANALOG MOD/FM/FM1 SOURCE.</li> <li>- Modulation frequency 1 kHz</li> </ul> </li> <li>➤ Read the distortion from the modulation analyzer.</li> </ul>

### 5.3.12.3 FM Frequency Response

#### FM frequency response up to 100 kHz

- Test assembly See section "Test Assemblies", standard test assembly for analog modulations with audio analyzer
- Measurement
- Settings on SMIQ:
    - Test frequencies 100, 750.1, 1099, 1101, 1499 MHz
    - Level 0 dBm
    - Select EXT1 in the menu ANALOG MOD/FM/FM1 SOURCE, deviation each:  $\frac{1}{4}$  of the maximum deviation.
  - Setting on audio analyzer:
    - Generator level 1 V ( $V_{peak}$ )
  - Vary the generator frequency of the audio analyzer from 10 Hz to 100 kHz to determine the modulation frequency response.
    - ⇒ The modulation frequency response is the difference between the greatest and the smallest modulation depth.
  - Repeat the measurement, applying the signal to socket EXT2 and with the setting ANALOG MOD/FM/FM2 SOURCE EXT2, only with CF 100 MHz.
  - Repeat the measurement with the internal modulation generator and with the setting ANALOG MOD/FM/FM1 SOURCE INT, only with CF 100 MHz.

#### Broadband FM frequency response up to 2 MHz

- Test assembly See section "Test Assemblies", broadband FM
- Measurement
- Settings on SMIQ:
    - Select EXT2 in the menu ANALOG MOD/FM/FM2 SOURCE and select deviation according to the table below.
    - Switch the voltmeter to DC measurement.
  - Vary the frequency in 10 kHz steps on the SMIQ or the auxiliary generator until the voltmeter indicates 0 V.
  - Switch the voltmeter to AC measurement and vary the frequency on the sine wave generator from 10 kHz to maximum frequency.
  - Measure the modulation frequency response with the AC voltmeter.
    - ⇒ The modulation frequency response is the difference between the greatest and the smallest modulation depth measured.
  - Repeat the measurement, applying the signal to socket EXT1 and with the setting MODULATION/FM/FM1 SOURCE EXT1.

Recommended settings:

<b>F (RF)</b>	50 MHz	750.1 MHz	1099 MHz	1101 MHz	1500 MHz	2200 MHz	3300 MHz	4400 MHz	6400 MHz
<b>Deviation</b>	500 kHz	250 kHz	250 kHz	250 kHz	250 kHz	500 kHz	500 kHz	1000 kHz	1000 kHz
<b>Mixer</b>	no	yes	yes	yes	yes	yes	yes	yes	yes
<b>F (LO)</b>	-	800.1 MHz	1149 MHz	1151 MHz	1550 MHz	2250 MHz	3350 MHz	4450 MHz	6450 MHz



#### 5.3.12.4 FM Preemphasis (optional)

Test assembly	See section "Test Assemblies", standard test assembly for analog modulations
Measurement	<ul style="list-style-type: none"> <li>➤ Settings on SMIQ:             <ul style="list-style-type: none"> <li>- Carrier frequency 100 MHz</li> <li>- Select INT in the menu ANALOG MOD/FM/FM1 SOURCE.</li> <li>- Deviation 25 kHz</li> <li>- LFGEN FREQ 15 kHz</li> </ul> </li> <li>➤ With a modulation frequency of 15 kHz, read the deviation from the modulation analyzer and note it down as a reference value.</li> <li>➤ Switch on preemphasis of 50 <math>\mu</math>s on the SMIQ and the modulation analyzer.             <ul style="list-style-type: none"> <li>⇒ The difference between the deviation now measured and the reference value is the deviation error with preemphasis. It should be less than 10% of the set maximum deviation.</li> </ul> </li> <li>➤ Repeat the measurement with a preemphasis of 75 <math>\mu</math>s.</li> </ul>

#### 5.3.12.5 Residual AM with FM

Test assembly	See section "Test Assemblies", standard test assembly for analog modulations
Measurement	<ul style="list-style-type: none"> <li>➤ Settings on SMIQ:             <ul style="list-style-type: none"> <li>- Level 0 dBm</li> <li>- Select INT in the menu MODULATION/FM/FM1 SOURCE.</li> <li>- Deviation 40 kHz</li> <li>- Modulation frequency 1 kHz</li> </ul> </li> <li>➤ Vary the carrier frequency from 5 MHz to <math>RF_{max}</math>. For recommended setting values see Table 5-2, at least * frequencies.</li> <li>➤ Measure the resulting amplitude modulation on the modulation analyzer with a 20 Hz highpass filter, a 3 kHz lowpass filter and peak detection.</li> </ul>

#### 5.3.12.6 Carrier Frequency Error with FM

Test assembly	See section "Test Assemblies", standard test assembly for analog modulations
Measurement	<ul style="list-style-type: none"> <li>➤ Settings on SMIQ:             <ul style="list-style-type: none"> <li>- Frequency 500 MHz</li> <li>- Level 0 dBm</li> <li>- Select INT in the menu ANALOG MOD/FM/FM1 SOURCE.</li> <li>- Deviation 0 kHz</li> </ul> </li> <li>➤ Setting on modulation analyzer             <ul style="list-style-type: none"> <li>- Counter function</li> </ul> </li> <li>➤ Measure the frequency error on switching on the FM.</li> <li>➤ Increase the deviation to 200 kHz on the SMIQ.</li> <li>➤ Measure the frequency error with FM with deviation.</li> </ul>

### 5.3.12.7 Level Monitoring at Input EXT2

Test assembly	See section "Test Assemblies", standard test assembly for analog modulations with audio analyzer
Test setup	➤ Connect the generator output of the audio analyzer to the external modulation input EXT2.
Measurement	➤ Same as for AM at input EXT1.

### 5.3.13 Phase Modulation (Option SM-B5)

**Note:** As a precondition for these measurements, the measurements described under "Frequency Modulation" must have been successfully concluded.

#### 5.3.13.1 Deviation Setting

Test assembly	See section "Test Assemblies", standard test assembly for analog modulations
Measurement	➤ Settings on SMIQ: <ul style="list-style-type: none"><li>- Carrier frequency 1000 MHz</li><li>- Level 0 dBm</li><li>- Select INT in the menu ANALOG MOD/PM/PM1 SOURCE.</li><li>- Modulation frequency 1 kHz</li><li>- For deviation see below</li></ul> ➤ Read the PhiM deviation from the modulation analyzer.
Recommended test deviations	0.03, 0.1, 0.3, 1, 3, 10 rad

#### 5.3.13.2 PhiM Distortion

Test assembly	See section "Test Assemblies", standard test assembly for analog modulations
Measurement	➤ Settings on SMIQ: <ul style="list-style-type: none"><li>- Carrier frequency 1 GHz</li><li>- Level 0 dBm</li><li>- Select INT in the menu ANALOG MOD/PM/PM1 SOURCE.</li><li>- Deviation 5 rad</li><li>- Modulation frequency 1 kHz</li></ul> ➤ Read the distortion from the modulation analyzer.

### 5.3.13.3 PhiM Frequency Response

Test assembly	See section "Test Assemblies", standard test assembly for analog modulations with audio analyzer
Measurement	<ul style="list-style-type: none"> <li>➤ Settings on SMIQ: <ul style="list-style-type: none"> <li>- Carrier frequency 1000 MHz</li> <li>- Level 0 dBm</li> <li>- Select EXT1 in the menu MODULATION/PM/PM1 SOURCE.</li> <li>- Deviation 5 rad</li> </ul> </li> <li>➤ Setting on audio analyzer: <ul style="list-style-type: none"> <li>- Generator level 1 V (<math>V_{peak}</math>)</li> </ul> </li> <li>➤ Vary the generator frequency of the analyzer to determine the modulation frequency response. <ul style="list-style-type: none"> <li>⇒ The modulation frequency response is the difference between the greatest and the smallest modulation depth.</li> </ul> </li> </ul> <p><b>Note:</b> For the FMB, it is recommended that the measurement be carried out as frequency modulation measurement as this provides higher accuracy; conversion to phase deviation with formula <math>m = deviation/f_{mod}</math>. Since no frequency response can occur below <math>f_{mod}</math> 1000 Hz because of the DC coupling, it is sufficient to measure the response starting from 1000 Hz (measurements below 1000 Hz are problematic since deviations are very small).</p> <ul style="list-style-type: none"> <li>➤ Repeat the measurement with the setting PM2 SOURCE EXT2.</li> <li>➤ Repeat the measurement with the setting PM1 SOURCE INT and variation of the frequency of the internal modulation generator.</li> </ul>

### 5.3.14 Digital Modulation (Option SMIQB20)

The basic functioning of the module can be checked by calling up the built-in test. To do this, select UTILITIES/TEST TEST MCODE in the menu. No fault messages should occur.

#### 5.3.14.1 Level Error and Residual Carrier with Digital Modulation

Test equipment	Spectrum analyzer (Table 5-1, item 2).
Test setup	Connect spectrum analyzer to the RF socket of the SMIQ.
Measurement	<ul style="list-style-type: none"> <li>➤ Settings on SMIQ <ul style="list-style-type: none"> <li>Level 0 dBm, test frequency</li> <li>Digital modulation, switch on standard GSM</li> <li>SOURCE PATTERN</li> <li>PATTERN 0</li> <li>SYMBOL RATE 300 kHz</li> <li>STATUS first on OFF.</li> </ul> </li> <li>➤ Settings on analyzer <ul style="list-style-type: none"> <li>CENTER FREQUENCY 1 GHz</li> <li>REFERENCE LEVEL 5 dBm</li> <li>SPAN 1 MHz</li> </ul> </li> <li>➤ Measure the level of the unmodulated signal as reference.</li> <li>➤ Settings on SMIQ <ul style="list-style-type: none"> <li>DIGITAL MOD/STATUS ON</li> <li>Now measure the carrier offset by the modulation by <math>\frac{1}{4}</math> of the symbol rate.</li> </ul> </li> <li>• It should not deviate by more than 0.3 dB of the reference value.</li> <li>➤ Residual carrier = the spectral line remaining at the carrier frequency.</li> <li>• It should be more than 50 dB below the reference value.</li> </ul>
Recommended test frequencies	100, 1472, (2200), 3300, 4400, 6400 MHz

### 5.3.14.2 Analog Outputs with Digital Modulation

Test equipment	AC voltmeter (Table 5-1, item 2), feed-through termination (Table 5-1, item 28).
Test setup	Connect AC voltmeter with feed-through termination to the I or Q socket of the SMIQ.
Measurement	<ul style="list-style-type: none"> <li>➤ Settings on SMIQ as above, <ul style="list-style-type: none"> <li>FREQ 1 GHz</li> </ul> </li> <li>• A sinewave signal with a frequency equal to symbol rate/4 with 0.5 V (peak) <math>\pm</math>5% amplitude into 50 <math>\Omega</math> should be measured at the I and Q output.</li> </ul>

### 5.3.14.3 Modulation Depth with ASK

Test equipment	Demodulator for digital modulation (Table 5-1, item 23)
Measurement	<ul style="list-style-type: none"> <li>➤ Settings on SMIQ: <ul style="list-style-type: none"> <li>- Level 0 dBm, RF 1 GHz</li> <li>- Switch on digital modulation ASK</li> <li>- ASK DEPTH 50 %</li> <li>- SYMBOL RATE 30 kHz</li> <li>- FILTER SPLIT PHASE/2.00</li> <li>- Data source PRBS, length 23 bits</li> </ul> </li> <li>➤ On the demodulator select <ul style="list-style-type: none"> <li>CENTER FREQUENCY 1 GHz</li> <li>REFERENCE LEVEL 5 dBm and in</li> <li>MODE VECTOR ANALYZER/ANALOG DEMOD</li> <li>MEAS RESULT/AM SIGNAL</li> <li>DEMOD BANDWIDTH 500kHz</li> <li>SWEEP TIME 200us</li> <li>MODULATION SUMMARY</li> </ul> </li> <li>➤ Read the AM modulation depth <math>\pm</math>Pk/2 on the demodulator.</li> <li>➤ It should be 50 <math>\pm</math>7%.</li> </ul>

### 5.3.14.4 Deviation Error with FSK

Test equipment	Demodulator for digital modulation (Table 5-1, item 23)
Measurement	<ul style="list-style-type: none"> <li>➤ Settings on SMIQ: <ul style="list-style-type: none"> <li>- Level 0 dBm, RF 1 GHz</li> <li>- Switch on digital modulation 2FSK</li> <li>- Symbol rate 1 kHz, deviation 200 Hz</li> <li>- Filter GAUSS 0.2</li> <li>- Data source PRBS, length 23 bits</li> </ul> </li> <li>➤ Make the corresponding settings on the demodulator in <ul style="list-style-type: none"> <li>MODE VECTOR ANALYZER/DIGITAL DEMOD,</li> <li>evaluation over 150 symbols, 10 averaging procedures</li> </ul> </li> <li>➤ Measure the FSK deviation error (rms) on the demodulator.</li> <li>➤ Repeat the measurement with 4FSK, filter parameter 0.7.</li> </ul>

### 5.3.14.5 Deviation Error with GFSK

Test equipment	Demodulator for digital modulation (Table 5-1, item 23)
Measurement	<ul style="list-style-type: none"> <li>➤ Settings on SMIQ:             <ul style="list-style-type: none"> <li>- Level 0 dBm, RF 1 GHz</li> <li>- Switch on digital modulation GFSK</li> <li>- Symbol rate 1300 kHz, deviation 650 kHz</li> <li>- Filter GAUSS 0.7</li> <li>- Data source PRBS, length 23 bits</li> </ul> </li> <li>➤ Make the corresponding settings on the demodulator, evaluation over 150 symbols, 10 averaging procedures</li> <li>➤ Measure the GFSK deviation error (rms) on the demodulator.</li> </ul>

### 5.3.14.6 Phase Error with GMSK

Test equipment	Demodulator for digital modulation (Table 5-1, item 23)
Measurement	<ul style="list-style-type: none"> <li>➤ Settings on SMIQ:             <ul style="list-style-type: none"> <li>- Level 0 dBm, RF 1 GHz</li> <li>- Switch on digital modulation GMSK</li> <li>- Symbol rate 1000 kHz</li> <li>- Filter GAUSS 0.3 and 1 kHz</li> <li>- Data source PRBS, length 23 bits</li> </ul> </li> <li>➤ Make the corresponding settings on the demodulator, evaluation over 150 symbols, 10 averaging procedures</li> <li>➤ Measure the GMSK phase error (rms) on the demodulator.</li> </ul>

### 5.3.14.7 Error Vector with PSK

Test equipment	Demodulator for digital modulation (Table 5-1, item 23)
Measurement	<ul style="list-style-type: none"> <li>➤ Settings on SMIQ:             <ul style="list-style-type: none"> <li>- Level 0 dBm, RF 1 GHz</li> <li>- Switch on digital modulation <math>\pi/4</math> DQPSK</li> <li>- Symbol rates 1/18/192/1500 and 3000 kHz</li> <li>- Filter SQR COS 0.25/0.35/0.5/0.7</li> <li>- Data source PRBS, length 23 bits</li> </ul> </li> <li>➤ Make the corresponding settings on the demodulator, evaluation over 150 symbols, 10 averaging procedures</li> <li>➤ Measure the error vector magnitude (rms) on the demodulator for all combinations of the given filters and symbol rates.</li> </ul>

### 5.3.14.8 Error Vector with QAM

Test equipment	Demodulator for digital modulation (Table 5-1, item 23)
Measurement	<ul style="list-style-type: none"> <li>➤ Settings on SMIQ:             <ul style="list-style-type: none"> <li>- Level 0 dBm, RF 1 GHz</li> <li>- Switch on digital modulation 16QAM</li> <li>- Symbol rates 1 and 3 MHz</li> <li>- Filter SQR COS 0.35</li> <li>- Data source PRBS, length 23 bits</li> </ul> </li> <li>➤ Make the corresponding settings on the demodulator, evaluation over 150 symbols, 10 averaging procedures</li> <li>➤ Measure the error vector magnitude (rms) on the demodulator for the given symbol rates.</li> </ul>

### 5.3.15 Data Generator and Memory Extension (Option SMIQB11/SMIQB12)

#### 5.3.15.1 Battery Test

- Measurement
- Setting to be made on SMIQ  
UTILITIES:TEST:DGEN RAM BATTERY
  - As result of the test triggered by pressing the SELECT key, "test passed" should be displayed.

#### 5.3.15.2 Function Test

Test equipment Storage oscilloscope (table 5-1, pos. 3) at outputs for serial and parallel modulation data, clock and control signals. Recommended: BNC adapter SMIQ-Z9 (Table 5-1, pos. 29). Pulse generator (table 5-1, pos. 17) at TRIGIN input of PAR DATA connector.

Test method The data generator is tested by programming the data sequences consisting of modulation data, trigger and control signals. The programmed sequences are stored in the data memory of the data generator and are read from there cyclically. Correct output of the programmed lists can be checked at the output connectors.

- Measurement
- PRESET settings of SMIQ:  
DIG.MOD :STATE:ON  
:MODULATION TYPE:256QAM 8b/sym  
:SYMBOL RATE:8500000.0sym/s  
:TRIGGER:TRIGGER SOURCE:EXT  
:MODE:ARMED AUTO  
:SOURCE :SOURCE:DATA\_LIST  
:SELECT DATA LIST:CREATE NEW LIST  
:EDIT DATA LIST:EDIT/VIEW

Generate the list shown below.

SELECT DATA LIST...	FREE 03330496	LEN 00000304	CURRENT: DLIST0	
EDIT DATA LIST...			-DATA-	
-BIT-				
00000001	10101111	01010101	01010101	01010101
00000033	00110011	00110011	00110011	00110011
00000065	00010001	00010001	00010001	00010001
00000097	01110111	01110111	01110111	01110111
00000129	00000000	00000000	00001110	10101111
00000161	01010101	01010101	01010101	00110011
00000193	00110011	00110011	00110011	00010001
00000225	00010001	00010001	00010001	01110111
00000257	01110111	01110111	01110111	00000000
00000289	00000000	00001110		

- Connect the storage oscilloscope to outputs DATA-D0 to D7, BURST, LEVATT, CW, HOP, TRIGGER OUT 1 to 3, SYMBCLK and input TRIGIN of rear-panel connector PARADATA. Trigger to the rising edge of the signal TRIGGER OUT 3.
- Feed a single pulse (HCT level) to the TRIGIN input (the rising edge is active).
- At the SYMBCLK output, the set symbol clock should be measurable with HCT level. The remaining output signals must be stable on the rising edge of the clock signal and have HCT level (see qualitative timing diagram below).
- The TRIGIN signal is read in on the rising edge of SYMBCLK. On the third falling edge of SYMBCLK following the read-in, the TRIGGER OUT 3 signal must change from LOW to HIGH and be stable on the next rising edge (see qualitative timing diagram below).
- Two symbol-clock periods following the signal TRIGGER OUT 3, the eight DATA signals DATA-D0 to D7 appear. A DATA sequence is 19 symbol-clock periods long, repeating cyclically. The following table shows the 19 states of each DATA signal on the rising edge of SYMBCLK.

**Timing Diagram**

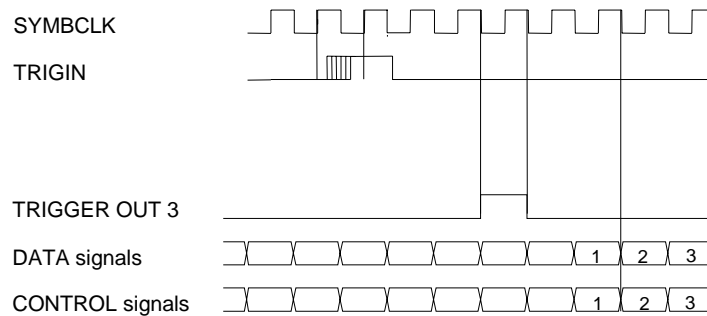

Table of DATA signal states

Symbol	1	2	3	4	5	6	7	8	9	10	11	12	13	14	15	16	17	18	19
D7	1	0	0	0	0	0	0	0	0	0	0	0	0	0	0	0	0	0	0
D6	0	1	1	1	0	0	0	0	0	0	0	0	1	1	1	1	0	0	0
D5	1	0	0	0	1	1	1	1	0	0	0	0	1	1	1	1	0	0	0
D4	0	1	1	1	1	1	1	1	1	1	1	1	1	1	1	1	0	0	0
D3	1	0	0	0	0	0	0	0	0	0	0	0	0	0	0	0	0	0	1
D2	1	1	1	1	0	0	0	0	0	0	0	0	1	1	1	1	0	0	1
D1	1	0	0	0	1	1	1	1	0	0	0	0	1	1	1	1	0	0	1
D0	1	1	1	1	1	1	1	1	1	1	1	1	1	1	1	1	0	0	0

Generate a CONTROL list:

- SMIQ settings:
  - DIG.MOD :SYMBOL RATE:1000000.0sym/s
  - :SOURCE :CONTROL STATE:ON
  - :SEL.CONTROL LIST:CREATE NEW LIST
  - :EDIT CONTROL LIST:EDIT/VIEW





### 5.3.15.4 Memory Test (including SMIQB12)

**Test method** The DATA editing function FILL may be used for the simple generation of a DATA sequence occupying the whole memory. Sufficient free space is to be available for this test. If this is not the case, existing DATA and CONTROL lists must be deleted or the test sequence shortened.

- The entered data are read and tested in a checksum test.

**Measurement**

- Setting to be made on SMIQ  
Press the PRESET key.  
DIG.MOD :STATE :OFF  
          :SOURCE :SOURCE:DATA\_LIST  
                  :SELECT DATA LIST:CREATE NEW LIST  
                  :EDIT DATA LIST:FILL

- The menu shown below should appear. Enter the listed DATA and the fill RANGE, which varies according to the version and extensions. For executing the FILL function, the memory space displayed in the list editor must be larger than the set fill range.

```

FILL AT    1    RANGE    <Filling range>

DATA      11111111 00000000 00000000 00000000

EXECUTE
```

The following table shows the fill range to be set and the checksum depending on the version and the number of fitted memory extensions (option SMIQB12).

**Note:** Data generator and memory extension must be of the same version.

Version	Number of SMIQB12 memory extensions	Fill range in bits (RANGE)	Max. memory depth in bits (FREE)	Checksum hex.
2	None	3 300 000	4M – 806.144k = 3388160	2B00 0000
2	1	11 000 000	12M – 806.144k = 11776768	3A00 0000
2	2	20 000 000	20M – 806.144k = 20165376	9800 0000
4	None	15 000 000	16M – 806.144k = 15971072	F200 0000
4	1	40 000 000	48M – 806.144k = 49525504	3000 0000
4	2	80 000 000	80M – 806.144k = 83079936	6000 0000

The entered data are now read and tested in a checksum test.

- Setting on SMIQ  
UTILITIES:TEST:GENERATE DM DATA LIST CHECKSUM
- The displayed checksum should agree with the values of the above table.
- To check the buffer battery, repeat the checksum test upon switching the unit off and on.

### 5.3.16 Digital Standards (Options)

#### 5.3.16.1 Adjacent-Channel Power Measurement with Higher Resolution

##### 5.3.16.1.1 Broadband Systems

Especially in measurements using the LOW-ACP filter (option SMIQB47), results are influenced by the inherent noise components of the analyzer. The procedure described below allows the measurement limit to be extended beyond that of standard settings.

- The adjacent-channel power measurements are made with the RF analyzer (Table 5-1, item 2) using the CHANNEL POWER marker function.
- To measure the channel power, set the CENTER FREQUENCY to the carrier frequency, SPAN to about twice the symbol rate, POWER MEAS SETTING/CHANNEL BANDWIDTH to about 1.4 times the symbol rate (unless otherwise specified), TRACE/DETECTOR RMS, SWEEP/TIME MANUAL to 1 s, REF LEVEL to approx. 3 to 5 dB below the PEP of the SMIQ, ATTEN AUTO LOW NOISE. Note down the channel power  $P_{\text{Chan}}$ .

**Note:** The dynamic range of the FSIQ is at its maximum with reference levels close below a 10 dB limit, for example -1 dB and 9 dBm with -11 dB.

- To measure the adjacent-channel power, detune the CENTER FREQUENCY by the channel spacing, set CHANNEL BANDWIDTH and SPAN (1.4 times the CHANNEL BANDWIDTH) anew if the adjacent-channel power is measured with a different bandwidth. To prevent a switchover of the analyzer attenuator, activate REF/RF ATTEN MANUAL. Reduce the REF LEVEL by 20 dB (unless otherwise specified). For some measurements the PLL bandwidth of the FSIQ must be set manually. This is done under COUPLING/MAIN PLL BANDWIDTH. Read the adjacent-channel power ACP. The measurement must be made for both sides (plus and minus the channel spacing); the worse value is the result to be taken.
- In critical cases, the inherent noise of the FSIQ must be determined and subtracted. To this end, press RF OFF on the SMIQ and read the inherent noise power  $P_{\text{FSIQ}}$  from the FSIQ. If the inherent noise power is below the previously measured power by more than 0.41 dB and less than 10 dB, the adjacent-channel power can be corrected as follows:
- $$P_{\text{Corr}} = 10 * \log_{10}(10^{(\text{ACP}/10)} - 10^{(\text{PFSIQ}/10)})$$
- The relative adjacent-channel power in dBc is  $\text{ACPR} = P_{\text{Chan}} - P_{\text{Corr}}$ .
- If the inherent noise power is less than 0.41 dB below the previously measured power, the power measured is the inherent noise power of the FSIQ; the component contributed by the SMIQ cannot be exactly determined, it is more than 10 dB below the measured value. If the inherent noise power is more than 10 dB below the previously measured power, a correction is not necessary since the noise component of the FSIQ is negligible.
- Since intermodulation products of the analyzer can be introduced especially in the first adjacent channel, the measurement should be repeated with a 3 dB attenuator at the analyzer input at least on preparing the test setup. The results must not be altered by this measurement.

### 5.3.16.1.2 Narrowband Systems

- With the systems NADC, TETRA and PDC implemented as standard, the contribution of the analyzer can be eliminated by way of calculation in a similar way. The noise, however, is derived from the synthesis of the analyzer (phase noise), so that it disappears on switching off the input signal. The reference measurement should therefore be performed with the **modulation** switched off. This method is correct when the noise spectrum of the unmodulated DUT is significantly below the modulated spectrum in the range of the measured adjacent channel.
- As implemented in the analyzer, the measurement of the relative adjacent-channel power is performed with the specified special settings. To reduce fluctuations in the measured values, the results are averaged over at least 5 measurements (ACPR).
- The DUT is then switched to CW using the MOD ON/OFF key. 5 measurements are again averaged (ACPRCW). Using the formula
 
$$ACPR_{corr} = 10 * \log_{10}(10^{(ACPR/10)} - 10^{(ACPRCW/10)})$$
 a correction calculation can be performed taking into account the above limitations.

### 5.3.16.2 GSM/EDGE

Test equipment	Demodulator for digital modulation with option K11 (Table 5-1, item 23)
Test setup	<ul style="list-style-type: none"> <li>➤ Connect the demodulator to the RF output of the DUT, connect the output TRIGGER OUT 2 (pin 23 of output PAR DATA, adapter SMIQ-Z5, table 5-1, pos. 29, recommended) to EXT TRIG GATE on the demodulator.</li> </ul>
GSM measurement	<ul style="list-style-type: none"> <li>➤ Settings on SMIQ: Level 0 dBm, RF 935.2 MHz and 2 GHz Switch on digital standard GSM/EDGE</li> <li>➤ Settings on demodulator: MODE/ GSM BTS analyzer SETTINGS/ EXTERNAL ATTENUATOR 46 dB POWER VS TIME CONTINUOUS FULL BURST</li> <li>➤ LIMIT CHECK : PASSED should be displayed on the demodulator.</li> <li>➤ Set demodulator to: PHASE/FREQUENCY ERROR SINGLE NO. OF BURSTS/ SET TO STANDARD</li> <li>➤ The status PASSED should be indicated; check phase errors (peak and rms) for compliance with data sheet tolerances.</li> <li>➤ Set demodulator to: TRANSIENT SPECTRUM/ SINGLE FREQ SWEEP</li> <li>➤ LIMIT CHECK : PASSED should be displayed on the demodulator.</li> <li>➤ On the SMIQ all SLOTS should be selected with BURST TYPE NORM and SLOT LEVEL FULL for the measurement of the modulation spectrum.</li> <li>➤ On the demodulator set MODULATION SPECTRUM; ARFCN +- 1.8 MHz and trigger the measurement with SINGLE FREQ SWEEP.</li> <li>➤ LIMIT CHECK PASSED should be displayed.</li> </ul>

- EDGE measurement
- The initial state is restored on the SMIQ with SAVE/RECALL FRAME...GET PREDEFINED FRAME...NB0 for the EDGE measurement.  
Then SLOT LEVEL ATTEN is set in SLOT 0 and SLOT 4 is selected with BURST TYPE EDGE and SLOT LEVEL FULL.
  - Settings on the analyzer:  
Select EDGE in MODE VECTOR ANALYZER/DIGITAL STANDARDS. Thus the SYNC PATTERN "edge\_ts0" is selected as a standard. The function EDIT SYNC PATTERN is used to display the pattern and to compare it with the pattern on the display of the SMIQ (necessary because of different modifications on the pattern). The pattern is corrected on the analyzer in case of deviations.  
⇒ The displayed vector error (rms) should not exceed 2% or (if available) the data sheet specification. The error messages "SYNC NOT FOUND"/"BURST NOT FOUND" should not be displayed.

### 5.3.16.3 DECT

- Test equipment Demodulator for digital modulation (Table 5-1, item 23)
- Measurement
- Settings on SMIQ:
    - Level 0 dBm, RF 1880 MHz
    - Switch on digital standard DECT.
  - Make the corresponding settings on the demodulator. Measure the DECT deviation error (rms) with the setting SYMB TABLE / ERRORS.
  - To measure the burst on/off ratio, operate the demodulator as a spectrum analyzer.  
Settings:
    - SPAN 0 Hz
    - RES BW 2 MHz
    - TRACE1 AVERAGE
    - TRIGGER/ VIDEO -40 dBm, SLOPE POS
    - SWEEP TIME MANUAL 1 ms
  - SLOT 0 should be displayed on the analyzer. Read the level in SLOT 0 and note it down.
  - On the DUT, set the SLOT LEVEL in SLOT 0 to OFF.  
All slots must now be switched off.
  - Switch on TRIGGER/ FREE RUN on the analyzer.
    - REF LEVEL -30 dBm and
    - RF ATTEN MANUAL 0 dB
  - Read the (blanked) level. With RF OFF on the DUT, the spacing to the analyzer's noise floor can be determined. If the spacing is less than 10 dB and more than 0.41 dB, the noise floor can be deducted (cf. section "Adjacent-Channel Power Measurement with Higher Resolution"). With less than 0.41 dB, the analyzer resolution is insufficient; the true measurement result is better by at least 10 dB. With more than 10 dB, correction is not necessary.
  - The burst on/off ratio is the difference between the two levels in dB.

### 5.3.16.4 NADC

Test equipment

Demodulator for digital modulation (Table 5-1, item 23)

Measurement

- Settings on SMIQ:  
Level 0 dBm, RF 824/894/1900 MHz  
Switch on digital standard NADC DOWNLINK.  
Select FILTER MODE LOW\_EVM for error vector measurement and LOW\_ACP for ACP measurement.
- Select standard NADC FWD CH on the demodulator and also make the other corresponding settings.  
Under SYMB TABLE / ERRORS, read the error vector magnitude (rms) for the RF frequencies given above.
- Adjacent-channel power measurement is implemented as standard in the FSIQ.  
LEVEL REF -5 dBm  
ATTEN AUTO LOW NOISE  
MARKER/ POWER MEAS SETTINGS:  
SET NO. OF ADJ CHANNELS 3  
Select ACP STANDARD NADC.  
MARKER/ ADJACENT CHANNEL POWER  
MARKER/ ADJUST CP SETTINGS  
In addition, set the PLL bandwidth to LOW in the menu COUPLING (after ADJUST CP SETTINGS).

**Note:** The measured values depend on the analyzer used. Typically -70 dBc is measured at a spacing of 60 kHz and -73 dBc at a spacing of 90 kHz using the FSIQ 26. Since the noise is caused by the synthesis, a higher resolution can be obtained using the procedure described in section "Adjacent-Channel Power Measurement with Higher Resolution, Narrowband Systems" (see above).

### 5.3.16.5 TETRA

Test equipment

Demodulator for digital modulation (Table 5-1, item 23).

Measurement

- Settings on SMIQ  
Level 0 dBm, test frequencies RF 451 MHz, 988 MHz  
Activate DIGITAL MOD/SELECT STANDARD TETRA for the error vector measurement FILTER MODE LOW\_EVM, select LOW\_ACP and LEVEL/LEVEL/OUTPUT MODE LOW\_DIST for ACP measurements.
- TETRA standard at the demodulator and make the other settings required,  
TRIGGER FIND BURST OFF,  
in SYMB TABLE / ERRORS read the error vector magnitude rms for the specified RF frequencies.
- Settings on SMIQ  
LEVEL -5 dBm (PEP).

- The adjacent-channel measurement is implemented as standard in the FSIQ
  - LEVEL REF to -5 dBm
  - ATTEN AUTO LOW NOISE
  - MARKER/ POWER MEAS SETTINGS/
  - SET NO. OF ADJ CHANNELS 2
  - Select ACP STANDARD TETRA
  - MARKER/ ADJACENT CHANNEL POWER
  - MARKER/ ADJUST CP SETTINGS

**Note:** *The measured values depend on the analyzer used. Using FSIQ26, 451 MHz typically -73 dBc is measured at a spacing of 25 kHz with MAIN PLL BANDWIDTH HIGH and -72 dBc at a spacing of 50 kHz with MAIN PLL BANDWIDTH LOW. Since the noise is caused by the synthesis, a higher resolution can be obtained using the procedure described in "Adjacent-Channel Power Measurement with Higher Resolution, Narrowband Systems" (see above). The test frequency in the lower band must be 451 MHz so that the correction without modulation does not suppress inherent noise components (switchover into divider range at CW).*

### 5.3.16.6 PDC

Test equipment

Demodulator for digital modulation (Table 5-1, item 23)

Measurement

- Settings on SMIQ:
  - Level 0 dBm, RF 810/956/1501 MHz
  - Switch on digital standard PDC DOWNLINK.
  - Select FILTER MODE LOW\_EVM for error vector measurement and LOW\_ACP for ACP measurement.
- Select LEVEL REF 5 dBm and standard PDC DOWN on the demodulator and also make the other corresponding settings. Under SYMB TABLE / ERRORS, read the error vector magnitude (rms) for the RF frequencies given above.
- Adjacent-channel power measurement is implemented as standard in the FSIQ, in addition the PLL bandwidth must be set to LOW in the menu COUPLING.

**Note:** *The measured values depend on the analyzer used. Typically -70 dBc is measured at a spacing of 50 kHz and -74 dBc at a spacing of 100 kHz with the aid of FSIQ26. Since the noise is caused by the synthesis, a higher resolution can be obtained with the procedure described in "Adjacent-Channel Power Measurement with Higher Resolution, Narrowband Systems" (see above). Make sure that correct power measurements are used to determine the correction. The test specification stipulates a peak detector. The results determined by this detector are corrected by the factor obtained from the power measurements.*

## 5.3.16.7 PHS

Test equipment	Demodulator for digital modulation (Table 5-1, item 23)
Measurement	<ul style="list-style-type: none"> <li>➤ Settings on SMIQ: Level 0 dBm, RF 1900 MHz Switch on digital standard PHS. Select FILTER MODE LOW_EVM for error vector measurement and LOW_ACP for ACP measurement.</li> <li>➤ Select LEVEL REF 5 dBm and standard PHS on the demodulator and also make the other corresponding settings. Under SYMB TABLE / ERRORS, read the error vector magnitude (rms).</li> <li>➤ Setting on SMIQ: DIGITAL MOD/SELECT STANDARD PHS</li> <li>➤ Set LEVEL REF -5 dBm ATTEN AUTO LOW NOISE on the demodulator. Adjacent-channel power measurement is implemented as standard in the FSIQ. Set POWER MEAS SETTINGS/ NO. OF CHANNELS to 3.</li> <li>➤ Pressing ALT1 furnishes the value for a 600 kHz offset, ALT2 for a 900 kHz offset.</li> <li>➤ <b>Note:</b> Especially the values at 900 kHz offset depend on the analyzer resolution (parameter scatter). If necessary, measure according to the procedure described in section "Adjacent-Channel Power Measurement with Higher Resolution, Broadband Systems" (see above). To measure the inherent noise, the SMIQ must be switched to RF OFF. To be able to deduct the inherent noise component of the FSIQ, the ACP ABS setting has to be used for the measurement. The inherent noise component of the adjacent channels can be deducted by means of the following formula: <math>ALTKorr = 10 * \log_{10}(10^{(ALT/10)} - 10^{(PALT/10)})</math>. ACPR is then ALTKORR - CH PWR</li> </ul>

### 5.3.17 IS-95 CDMA (Option SMIQB42)

#### Rho factor

Test equipment	Demodulator for digital modulation (Table 5-1, item 23)
Measurement	<ul style="list-style-type: none"> <li>➤ Settings on SMIQ:           <ul style="list-style-type: none"> <li>1st measurement               <ul style="list-style-type: none"> <li>- Level -15 dBm, RF 824/894/1900 MHz</li> <li>- Switch on digital modulation IS95 CDMA.</li> <li>- Select MODE FWD_LINK_18.</li> <li>- Select filter mode LOW_EVM.</li> <li>- Switch off all code channels except pilot.</li> <li>- Set power for pilot channel to 0 dB.</li> </ul> </li> <li>2nd measurement               <ul style="list-style-type: none"> <li>- Select MODE REV_LINK, full rate, data 0000.</li> </ul> </li> </ul> </li> <li>➤ Settings on demodulator:           <ul style="list-style-type: none"> <li>REF LEVEL -10 dBm</li> </ul> </li> <li>1st measurement: select DIGITAL STANDARDS QCDMA FWD.</li> <li>2nd measurement: select QCDMA REV CH.</li> <li>- Evaluation over 600 symbols</li> </ul>

#### Adjacent-channel power

Test equipment	RF spectrum analyzer (Table 5-1, item 2)
Test setup	Connect the spectrum analyzer to the RF output of the SMIQ.
Measurement	<ul style="list-style-type: none"> <li>➤ Settings on SMIQ:           <ol style="list-style-type: none"> <li>1. Reverse Link               <ul style="list-style-type: none"> <li>- DIG STD IS95</li> <li>- MODE REV_LINK</li> <li>- IQ FILTER 850 kHz</li> <li>- DATA PRBS</li> <li>- Level (PEP) <math>P_{vm_{max}}</math> and <math>P_{vm_{min}}</math></li> </ul> </li> <li>2. Forward Link 9Chan               <ul style="list-style-type: none"> <li>- Switch on DIG STD IS95.</li> <li>- Select MODE FWD_LINK_18.</li> <li>- SAVE/RCL MAPPING, GET PREDEFINED MAPPING, 09CHAN</li> <li>- IQ FILTER 850 kHz</li> <li>- Level (PEP) 0.2 and -0.2 dBm</li> <li>- RF 824/894/1850/2000 MHz</li> </ul> </li> </ol> </li> <li>➤ Setting on spectrum analyzer           <ul style="list-style-type: none"> <li>- LEVEL REF -5 dBm</li> </ul> </li> <li>➤ Test procedure           <p>As described in section "Adjacent-Channel Power Measurement with Higher Resolution, Broadband Systems" above, channel bandwidth 1.2288 MHz, adjacent-channel bandwidth 30 kHz, channel spacings 885 kHz, 1.25 MHz, 1.98 MHz. The PLL bandwidth of the FSIQ must be set to LOW.</p> </li> </ul>



### 5.3.18 W-CDMA - NTT DoCoMo/ARIB 0.0 (Option SMIQB43)

#### Error vector

Test equipment

Demodulator for digital modulation (Table 5-1, item 23)

Measurement

- Settings on SMIQ:
  - Level -10 dBm
  - RF 1800/2000/2200 MHz
  - Select digital standard W-CDMA with the following settings:
    - SET DEFAULT
    - MODE 4CHAN
    - CHIP RATE 4.096 M
    - LINK DIR DOWN
    - SEQUENCE LENGTH 10 frames
    - MODULATION FILTER MODE LOW\_EVM
    - CHNO 0 TYPE DPCH, SYMBOL RATE 32, SHO CO 9, POWER 0, DATA PN9, TPC ALT
    - Switch the other channels off (STATE OFF).
- Settings on demodulator:
  - REF LEVEL -5 dBm
  - DIGITAL STANDARDS W-CDMA FWD CH
  - Evaluation over 600 symbols

#### Adjacent-channel power

Test equipment

RF spectrum analyzer (Table 5-1, item 2)

Measurement

- Settings on SMIQ:
  - Level (PEP)  $P_{vm_{max}}$  and  $P_{vm_{min}}$
  - RF 1800/2000/2200 MHz
  - Select digital standard W-CDMA with the following settings:
    - SET DEFAULT
    - MODE 4CHAN
    - LINK DIR DOWN
    - SEQUENCE LENGTH 10 frames
    - MODULATION FILTER MODE LOW\_ACP
    - CHNO 1 TYPE DPCH, SYMBOL RATE 32, SHO CO 9, POWER 0, DATA PN 9, TPC ALT
    - Switch the other channels off (STATE OFF).
    - For 5 MHz offset select LOW NOISE and for 10 MHz LOW DISTORTION in the LEVEL/LEVEL/OUTPUT MODE menu.
- Settings on spectrum analyzer:
  - Determine the channel power and the adjacent-channel power at a bandwidth of 4.096 MHz and spacings of 5 MHz and 10 MHz in accordance with section "Adjacent-Channel Power Measurement with Higher Resolution, Broadband Systems" above.

**5.3.19 3GPP W-CDMA for SMIQ with firmware version up to 5.20 (Options SMIQB20 and SMIQB45)**

**5.3.19.1 3GPP W-CDMA with 1 Code Channel**

Test equipment RF spectrum analyzer (Table 5-1, item 2)

- Measurement
- General settings on SMIQ
    - Level (PEP)  $P_{vm_{max}}$  and  $P_{vm_{min}}$
    - RF 1800, 2000 and 2200 MHz
  - Modulation settings on SMIQ:
    - SET DEFAULT
    - 3GPP VERSION 2.1.0
    - CHIP RATE 4.096 M
    - LINK DIRECTION DOWN/FORWARD
    - SEQUENCE LENGTH 10
    - CLIPPING LEVEL 100%
    - FILTER WCDMA 0.22

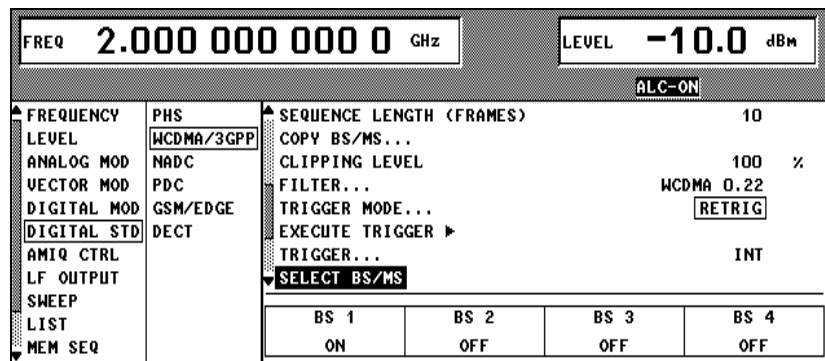
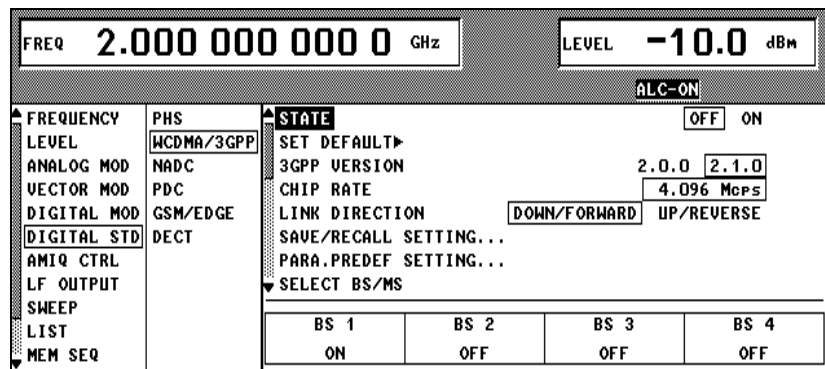

- Menu **PARA. PREDEF** (all parameters and channel tables of the base station are automatically set)
  - PERCH OFF
  - SCCPCH OFF
  - NUMBER OF DPCH 1
  - SYMBOL RATE 32 ksym/s
  - CREST MINIMUM

- EXECUTE

FREQ <b>2.000 000 000 0</b> GHz		LEVEL <b>-10.0</b> dBm	
ALC-ON			
▲ FREQUENCY	PHS	STATE	PERCH
LEVEL	WCDMA/3GPP	SET D	SCCPCH
ANALOG MOD	NADC	3GPP	<input type="checkbox"/> OFF <input type="checkbox"/> ON sym/s
VECTOR MOD	PDC	CHIP	NUMBER OF DPCH
DIGITAL MOD	GSM/EDGE	LINK	1
DIGITAL STD	DECT	SAVE/P	SYMBOL RATE
AMIQ CTRL		PARA.	CREST
LF OUTPUT		SELEC	<input type="checkbox"/> MINIMUM <input type="checkbox"/> AVERAGE <input type="checkbox"/> WORST
SWEEP			<input type="checkbox"/> 32k sym/s
LIST			
MEM SEQ			
			<b>EXECUTE ▶</b>

- The following settings result from this selection:
  - BS 1 ON, all other channels BS OFF

➤ Menu Select BS/MS: BS1

FREQ <b>2.000 000 000 0</b> GHz		LEVEL <b>-10.0</b> dBm	
ALC-ON			
▲ BS 1			<input type="checkbox"/> OFF <input checked="" type="checkbox"/> ON
LONG CODE INIT		000 0000 1000	H
T SECTOR		0	
TFCI STATE (DPCH)		<input type="checkbox"/> OFF <input type="checkbox"/> ON	
TFCI (DPCH)		0	
2ND SEARCH CODE GROUP (PERCH)		1	
POWER OFFSET P-SCH		0.0	dB
POWER OFFSET S-SCH		0.0	dB
MISUSE TPC FOR OUTPUT POWER CTRL		<input type="checkbox"/> OFF <input type="checkbox"/> ON	
POWER STEP TPC		0.0	dB
TRANSMIT DIVERSITY		<input type="checkbox"/> OFF	ANTENNA_1 ANTENNA_2

- Channel table:
  - CHNO 2
  - TYPE DPCH
  - SYMB RATE 32k
  - SPREAD. CODE 0
  - POWER 0 dB
  - DATA PN 15
  - OFFS 0
  - TPC ALLO
  - MC STATE OFF, STATE ON
- All other channels: STATE OFF

FREQ		100.000 000 0 MHz				LEVEL		-30.0 dBm		
ALC-ON										
▲ TRANSMIT DIVERSITY <span style="float: right;">OFF ANTENNA_1 ANTENNA_2</span>										
MULTI CHANNEL EDIT...										
CODE DOMAIN (Hardkey: STATUS) ▶										
CHANNEL GRAPH ▶										
CHNO	TYPE	SYMB	RATE	SPR. COD	POW/DB	DATA	OFFS	TPC	MC	STATE
0	PERCH	16	0	0.0	0.0	PN15	0			OFF
1	SCCPCH	64	0	0.0	0.0	PN15	0			OFF
2	DPCH	32	0	0.0	0.0	PN15	0	ALLO	OFF	ON
3	DPCH	32	45	0.0	0.0	PN15	9	ALLO	OFF	OFF
4	DPCH	32	86	0.0	0.0	PN15	12	ALLO	OFF	OFF
5	DPCH	32	0	0.0	0.0	PN15	0	ALLO	OFF	OFF

- Settings on demodulator for error vector measurements
  - REF LEVEL same as PEP on SMIQ
  - DIGITAL STANDARDS W-CDMA FWD CH
  - Evaluation over 600 symbols
- Measure EVM (observe data in data sheet), filter mode LOW\_EVM, for SMIQB47 without and with filter 2.5 MHz.
- Measure adjacent-channel power (ACPR) (cf. section "Adjacent-Channel Power Measurement with Higher Resolution, Broadband Systems" above), filter mode LOW\_ACP, bandwidth of channel and adjacent channel 4.096 MHz, for SMIQB47 without and with filter 2.5 MHz.

### 5.3.19.2 3GPP W-CDMA with 8 Code Channels

Test equipment

RF spectrum analyzer (Table 5-1, item 2)

Measurement

- General settings on SMIQ
  - Level (PEP)  $P_{vm_{max}}$  and  $P_{vm_{min}}$
  - RF 1800, 2000 and 2200 MHz
- Modulation settings on SMIQ:
  - SET DEFAULT
  - 3GPP VERSION 2.1.0
  - CHIP RATE 4.096 M
  - LINK DIRECTION DOWN/FORWARD
  - SEQUENCE LENGTH 10
  - CLIPPING LEVEL 100%
  - FILTER WCDMA 0.22, same as 3GPP W-CDMA with 1 code channel
- Menu **PARA. PREDEF** (all parameters and channel tables of the base station are automatically set)
  - PERCH OFF
  - SCCPCH OFF
  - NUMBER OF DPCH 8
  - SYMBOL RATE 32 ksym/s
  - CREST MINIMUM
  - EXECUTE

FREQ <b>100.000 000 0</b> MHz		LEVEL <b>-30.0</b> dBm	
ALC-ON			
▲ FREQUENCY	PHS	▲ STATE	PERCH OFF <input type="checkbox"/> ON <input type="checkbox"/>
LEVEL	WCDMA/3GPP	SET D	SCCPCH <input type="checkbox"/> OFF sym/s
ANALOG MOD	NADC	3GPP	
VECTOR MOD	PDC	CHIP	NUMBER OF DPCH 8
DIGITAL MOD	GSM/EDGE	LINK	
DIGITAL STD	DECT	SAVE/	SYMBOL RATE <input type="checkbox"/> 32k sym/s
AMIQ CTRL		PARA.	CREST <input type="checkbox"/> MINIMUM <input type="checkbox"/> AVERAGE <input type="checkbox"/> WORST
LF OUTPUT		▼ SELEC	
SWEEP			<b>EXECUTE ▶</b>
LIST		BS	
▼ MEM SEQ		0	

- The following settings result from this selection:
  - BS 1 ON, all other channels BS OFF

- Menu Select BS/MS: BS1

FREQ <b>2.000 000 000 0</b> GHz		LEVEL <b>-10.0</b> dBm	
ALC-ON			
▲ <b>BS 1</b>			OFF <input type="checkbox"/> ON <input type="checkbox"/>
LONG CODE INIT		000 0000 1000	H
T SECTOR		0	
TFCI STATE (DPCH)		<input type="checkbox"/> OFF	ON
TFCI (DPCH)		0	
2ND SEARCH CODE GROUP (PERCH)		1	
POWER OFFSET P-SCH		0.0	dB
POWER OFFSET S-SCH		0.0	dB
MISUSE TPC FOR OUTPUT POWER CTRL		<input type="checkbox"/> OFF	ON
POWER STEP TPC		0.0	dB
▼ TRANSMIT DIVERSITY		<input type="checkbox"/> OFF	ANTENNA_1 ANTENNA_2

- Channel table: CHNO 2 to 9:

CHNO	SPREAD. CODE	OFFS	Common parameter
2	0	0	TYPE DPCH
3	16	3	SYMB RATE 32k
4	32	6	POWER 0 dB,
5	48	9	DATA PN 15
6	64	12	TPC ALL0
7	80	15	MC STATE OFF
8	96	18	STATE ON
9	112	21	

- All other channels: STATE OFF

FREQ <b>100.000 000 0</b> MHz						LEVEL <b>-30.0</b> dBm				
ALC-ON										
CHNO	TYPE	SYMB	RATE	SPR. COD	POW/DB	DATA	OFFS	TPC	MC	STATE
0	PERCH		16	0	0.0	PN15	0			OFF
1	SCCPCH		64	1	0.0	PN15	3			OFF
2	DPCH		32	0	0.0	PN15	0	ALLO	OFF	ON
3	DPCH		32	16	0.0	PN15	3	ALLO	OFF	ON
4	DPCH		32	32	0.0	PN15	6	ALLO	OFF	ON
5	DPCH		32	48	0.0	PN15	9	ALLO	OFF	ON
6	DPCH		32	64	0.0	PN15	12	ALLO	OFF	ON
7	DPCH		32	80	0.0	PN15	15	ALLO	OFF	ON
8	DPCH		32	96	0.0	PN15	18	ALLO	OFF	ON
9	DPCH		32	112	0.0	PN15	21	ALLO	OFF	ON

- For 5 MHz offset, select LOW DISTORTION in the LEVEL/LEVEL/OUTPUT MODE menu and for 10 MHz select LOW NOISE.
- Measure the adjacent-channel power (ACPR) (cf. section "Adjacent-Channel Power Measurement with Higher Resolution, Broadband Systems" above), filter mode LOW\_ACP, bandwidth of channel and adjacent channel 4.096 MHz, for SMIQB47 without and with filter 2.5 MHz.

### 5.3.20 3GPP W-CDMA for SMIQ with Firmware Versions 5.30 or Higher (Options SMIQB20 and SMIQB45)

#### 5.3.20.1 3GPP W-CDMA with 1 Code Channel

Test equipment RF spectrum analyzer (Table 5-1, item 2)

- Measurement
- General settings on SMIQ
    - Level (PEP)  $P_{vm_{max}}$  and  $P_{vm_{min}}$
    - RF 1800, 2000 and 2200 MHz
  - Modulation settings on SMIQ:
    - SET DEFAULT(confirm with SELECT)
    - 3GPP VERSION (current version is displayed)
    - CHIP RATE 3.84 Mcps
    - LINK DIRECTION DOWN/FORWARD
    - SEQUENCE LENGTH 10
    - CLIPPING LEVEL 100%
    - FILTER WCDMA 0.22

FREQ <b>2.000 000 000 0</b> GHz						LEVEL <b>-10.0</b> dBm		PEP <b>-4.6</b> dBm	
ALC-S&H									
WCDMA/3GPP									
FREQUENCY	PHS	STATE							
LEVEL	IS95	OFF <input type="checkbox"/>							
ANALOG MOD	WCDMA	SET DEFAULT▶							
VECTOR MOD	WCDMA/3GPP	SAVE/RECALL SETTING...							
DIGITAL MOD	NADC	TEST MODELS...							
DIGITAL STD	PDC	General Settings							
ARB MOD	GSM/EDGE	3GPP VERSION		3.1.1					
BERT	DECT	CHIP RATE		3.84		Mcps			
LF OUTPUT		SELECT BS/MS							
SWEEP		BS 1	BS 2	BS 3	BS 4				
LIST		ON	OFF	OFF	OFF				

FREQ <b>2.000 000 000 0</b> GHz		LEVEL -10.0 dBm	PEP -4.6 dBm
<b>WCDMA/3GPP</b>		<b>ALC-S&amp;H</b>	
FREQUENCY	PHS IS95	CHIP RATE	3.84 Mcps
LEVEL	WCDMA	LINK DIRECTION	DOWN/FORWARD UP/REVERSE
ANALOG MOD	WCDMA/3GPP	SEQUENCE LENGTH	10 Frame
VECTOR MOD	NADC	CLIPPING LEVEL	100 %
DIGITAL MOD	PDC	FILTER...	WCDMA 0.22
DIGITAL STD	GSM/EDGE	Assistant/Enhanced Functions	
ARB MOD	DECT	PARA.PREDEF SETTING...	
BERT		SELECT BS/MS	
LF OUTPUT		BS 1	BS 2
SWEEP		ON	OFF
LIST		BS 3	BS 4
		OFF	OFF

- Menu **PARA. PREDEF** (all parameters and channel tables of the base station are automatically set)
  - CHANNELS FOR SYNC OF MOBILE OFF
  - S-CCPCH OFF
  - NUMBER OF DPCH 1
  - SYMBOL RATE 30 ksps
  - CREST MINIMUM
  - EXECUTE

FREQ <b>2.000 000 000 0</b> GHz		LEVEL -10.0 dBm	PEP -4.6 dBm
<b>WCDMA/3GPP</b>		<b>ALC-S&amp;H</b>	
FREQUENCY	PHS IS95	CHIP	CHANNELS FOR SYNC OF MOBILE OFF ON
LEVEL	WCDMA	LINK	S-CCPCH OFF ksps
ANALOG MOD	WCDMA/3GPP	SEQUENCE	NUMBER OF DPCH 1
VECTOR MOD	NADC	CLIPPING	SYMBOL RATE 30 ksps
DIGITAL MOD	PDC	FILTER	CREST MINIMUM
DIGITAL STD	GSM/EDGE	PARA.	<b>EXECUTE ▶</b>
ARB MOD	DECT	SELEC	
BERT		BS	
LF OUTPUT		0	
SWEEP			
LIST			

- The following settings result from this selection:
  - BS 1 ON, all other channels BS OFF

- Menu Select BS/MS: BS1

FREQ <b>2.000 000 000 0</b> GHz		LEVEL -10.0 dBm	PEP -4.6 dBm
<b>WCDMA/3GPP</b>		<b>ALC-S&amp;H</b>	
<b>BS 1</b>		OFF	ON
SCRAMBLING CODE		0 0001	H
TFCI STATE		OFF	ON
TFCI			1
2ND SEARCH CODE GROUP			1
TPC PATTERN/DLIST READ OUT MODE		CONTINUOUS	
MISUSE TPC FOR OUTPUT POWER CTRL		OFF	ON
POWER STEP TPC			0.0 dB
TRANSMIT DIVERSITY		OFF	ANTENNA_1 ANTENNA_2
NUMBER OF PAGE INDICATORS PER FRAME			36
MULTI CHANNEL EDIT...			

- Channel table:
  - CHNO 11
  - TYPE DPCH
  - SYMB RATE 30 ksps
  - CHAN. CODE 0
  - POWER 0dB
  - DATA PN 15
  - T OFFS 0
  - PILOT LENGTH 4
  - TPC PATTERN ("0011")
  - MC STATE OFF, STATE ON
- All other channels: STATE OFF

FREQ		2.000 000 000 0 GHz				LEVEL		-10.0 dBm		
						PEP		-4.6 dBm		
WCDMA/3GPP					ALC-S&H					
MULTI CHANNEL EDIT...										
ENHANCED CHANNELS... OFF										
CODE DOMAIN (Hardkey: STATUS) ▶										
CHANNEL GRAPH ▶										
CHNO	TYPE	SYM. RATE	CH. COD	POW/DB	DATA	TOFFS	PILOT	TPC	MC	STATE
0	P-CPICH	15	0	0.0						OFF
1	S-CPICH	15	0	0.0						OFF
2	P-SCH	15		0.0						OFF
3	S-SCH	15		0.0						OFF
4	P-CCPCH	15	1	0.0	PN15					OFF
5	S-CCPCH	15	0	0.0	PN15					OFF

FREQ		2.000 000 000 0 GHz				LEVEL		-10.0 dBm		
						PEP		-4.6 dBm		
WCDMA/3GPP					ALC-S&H					
MULTI CHANNEL EDIT...										
ENHANCED CHANNELS... OFF										
CODE DOMAIN (Hardkey: STATUS) ▶										
CHANNEL GRAPH ▶										
CHNO	TYPE	SYM. RATE	CH. COD	POW/DB	DATA	TOFFS	PILOT	TPC	MC	STATE
5	S-CCPCH	15	0	0.0	PN15					OFF
6	PICH	15	0	0.0	PN15					OFF
7	AP-AICH	15	0	0.0				PATT		OFF
8	CD-AICH	15	0	0.0				PATT		OFF
9	PDSCH	15	0	0.0	PN15					OFF
10	DL-DPCCH	7.5	0	0.0				PATT		OFF
11	DPCH	30	0	0.0	PN15	0	4	PATT	OFF	ON
12	DPCH	15	0	0.0	PN15	0	4	PATT	OFF	OFF
13	DPCH	15	0	0.0	PN15	0	4	PATT	OFF	OFF
14	DPCH	15	0	0.0	PN15	0	4	PATT	OFF	OFF

- Settings on demodulator for error vector measurements
  - REF LEVEL same as PEP on SMIQ
  - DIGITAL STANDARDS W-CDMA FWD CH
  - Evaluation over 600 symbols
- Measure EVM (observe data in data sheet), filter mode LOW\_EVM, for SMIQB47 without and with filter 2.5 MHz.
- Measure adjacent-channel power (ACPR) (cf. section "Adjacent-Channel Power Measurement with Higher Resolution, Broadband Systems" above), filter mode LOW\_ACP, bandwidth of channel and adjacent channel 3.84 MHz, for SMIQB47 without and with filter 2.5 MHz.



### 5.3.20.2 3GPP W-CDMA with 8 Code Channels

Test equipment

RF spectrum analyzer (Table 5-1, item 2)

Measurement

- General settings on SMIQ
  - Level (PEP)  $P_{vm_{max}}$  and  $P_{vm_{min}}$
  - RF 1800, 2000 and 2200 MHz
- Modulation settings on SMIQ (same as 3GPP W-CDMA with 1 code channel):
  - SET DEFAULT (confirm with SELECT)
    - 3GPP VERSION (current version is displayed)
    - CHIP RATE 3.84 Mcps
    - LINK DIRECTION DOWN/FORWARD
    - SEQUENCE LENGTH 10
    - CLIPPING LEVEL 100%
    - FILTER WCDMA 0.22,
- Menu **PARA. PREDEF** (all parameters and channel tables of the base station are automatically set)
  - CHANNELS FOR SYNC OF MOBILE OFF
  - S-CCPCH OFF
  - NUMBER OF DPCH 8
  - SYMBOL RATE 30 ksps
  - CREST MINIMUM
  - EXECUTE

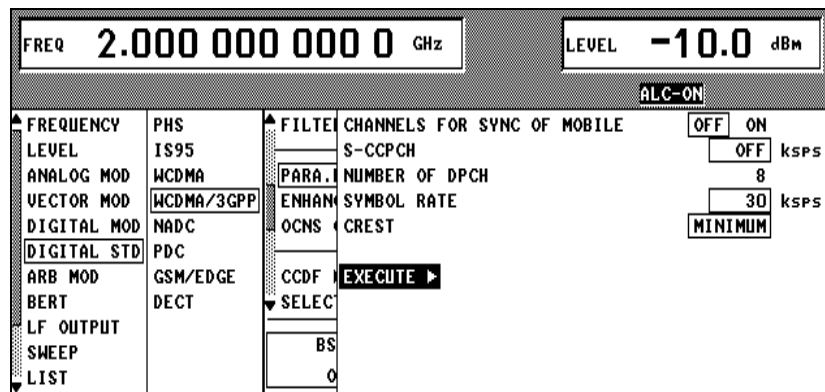

- The following settings result from this selection:
  - BS 1 ON, all other channels BS OFF

- Menu Select BS/MS: BS1

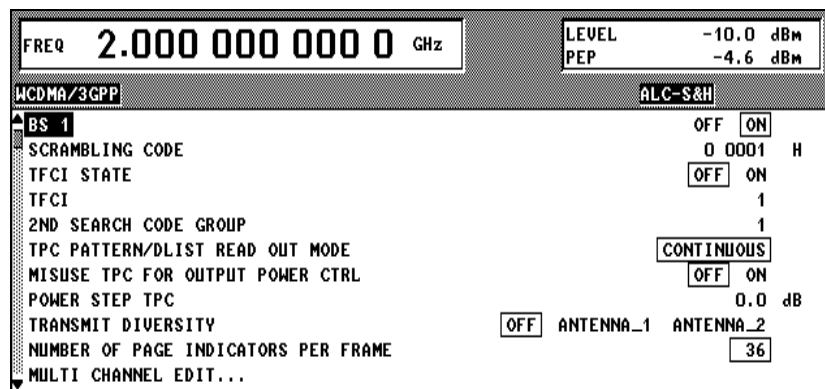

- Channel table: CHNO 11 to 18:

CHNO	CHAN. CODE	T OFFS	Common parameter
11	16	0	TYPE DPCH
12	32	3	SYMB RATE 30ksps
13	48	6	POWER 0 dB,
14	64	9	DATA PN 15
15	80	12	PILOT LENGTH 4
16	96	15	TPC PATTERN ("0011")
17	112	18	MC STATE OFF
18	0	21	STATE ON

➤ All other channels: STATE OFF

FREQ		2.000 000 000 0 GHz		LEVEL		-10.0 dBm				
				PEP		-0.7 dBm				
WCDMA/3GPP				ALC-S&H						
CHNO	TYPE	SYM. RATE	CH. COD	POW/DB	DATA	TOFFS	PILOT	TPC	MC	STATE
0	P-CPICH	15	0	0.0						OFF
1	S-CPICH	15	0	0.0						OFF
2	P-SCH	15		0.0						OFF
3	S-SCH	15		0.0						OFF
4	P-CCPCH	15	1	0.0	PN15					OFF
5	S-CCPCH	15	0	0.0	PN15					OFF
6	PICH	15	0	0.0	PN15					OFF
7	AP-AICH	15	0	0.0				PATT		OFF
8	CD-AICH	15	0	0.0				PATT		OFF
9	PDSCH	15	0	0.0	PN15					OFF

FREQ		2.000 000 000 0 GHz		LEVEL		-10.0 dBm				
				PEP		-0.7 dBm				
WCDMA/3GPP				ALC-S&H						
CHNO	TYPE	SYM. RATE	CH. COD	POW/DB	DATA	TOFFS	PILOT	TPC	MC	STATE
10	DL-DPCCH	7.5	0	0.0				PATT		OFF
11	DPCH	30	16	0.0	PN15	0	4	PATT	OFF	ON
12	DPCH	30	32	0.0	PN15	3	4	PATT	OFF	ON
13	DPCH	30	48	0.0	PN15	6	4	PATT	OFF	ON
14	DPCH	30	64	0.0	PN15	9	4	PATT	OFF	ON
15	DPCH	30	80	0.0	PN15	12	4	PATT	OFF	ON
16	DPCH	30	96	0.0	PN15	15	4	PATT	OFF	ON
17	DPCH	30	112	0.0	PN15	18	4	PATT	OFF	ON
18	DPCH	30	0	0.0	PN15	21	4	PATT	OFF	ON
19	DPCH	15	0	0.0	PN15	0	4	PATT	OFF	OFF

➤ Measure adjacent-channel power (ACPR) (cf. section "Adjacent-Channel Power Measurement with Higher Resolution, Broadband Systems" above), filter mode LOW\_ACP, bandwidth of channel and adjacent channel 3.84 MHz, for SMIQB47 without and with filter 2.5 MHz.

### 5.3.20.3 3GPP W-CDMA Test Model 1, 64 DPCH

This measurement will replace the 3GPP W-CDMA measurement with 8 code channels from software version 5.60.

Test equipment

RF spectrum analyzer (Table 5-1, item 2)

Measurement

➤ General setting on SMIQ

- Level (PEP)  $P_{vm_{max}}$  and  $P_{vm_{min}}$
- RF 1800, 2000 and 2200 MHz

➤ Modulation settings on SMIQ (as for W-CDMA/3GPP with 1 code channel):

- SET DEFAULT (confirm with SELECT)
- TEST MODELS...
- TEST1\_64
- STATE ON

- Measure adjacent-channel power (ACPR) (cf. section "Adjacent-Channel Power Measurement with Higher Resolution, Broadband Systems", filter mode LOW\_ACP, bandwidth for channel and adjacent channel 3.84 MHz, when SMIQB47 is used without and with 2.5 MHz filter. For 5 MHz offset, select LOW DISTORTION in the LEVEL/LEVEL/OUTPUT MODE menu and for 10 MHz select LOW NOISE.

### 5.3.21 3GPP W-CDMA Enhanced Channels (SMIQB48)

#### 5.3.21.1 External Power Control

Test equipment RF spectrum analyzer (Table 5-1, item 2)  
 DC-voltage source as LEVATT input signal (Table 5-1, item 12)

- Measurement
- General setting at SMIQ
    - Level -10 dBm
    - Test frequency 2000 MHz
  - Modulation settings on SMIQ:  
 Menu **DIGITAL STD/WCDMA 3GPP:**  
 SET DEFAULT
    - LINK DIRECTION DOWN/FORWARD
    - SEQUENCE LENGTH 1
    - CLIPPING LEVEL 100%
    - FILTER WCDMA 0.22

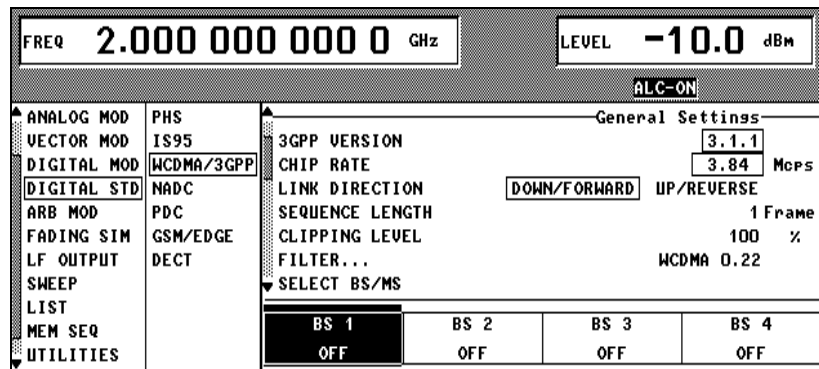

- Menu **BS/MS1/ENHANCED CHANNELS**
  - ENHANCED CHANNELS STATE ON
  - EXTERNAL POWER CONTROL STATE ON
  - POWER STEP 1.0 dB
  - POWER UP RANGE 10 dB
  - POWER DOWN RANGE 10 dB
  - CHANNEL NUMBER 11
  - STATE ON
  - POWER CONTROL UP

FREQ		2.000 000 000 0 GHz		LEVEL		-10.0 dBm		
ALC-ON								
POWER	ENHANCED CHANNELS STATE						OFF	ON
TRANS	Channel Coding							
NUMBE	CHANNEL CODING STATE						OFF	ON
MULTI	CODING TYPE						MEASURE	12.2
ENHAF	INTERLEAVER 1						OFF	ON
CODE	INTERLEAVER 2						OFF	ON
CHANP	External Power Control							
-CHNO-	EXTERNAL POWER CONTROL STATE						OFF	ON
0	POWER STEP						1.0	dB
1	POWER UP RANGE						10.0	dB
2	POWER DOWN RANGE						10.0	dB

FREQ		2.000 000 000 0 GHz		LEVEL		-10.0 dBm	
ALC-ON							
POWER	Specific Enhanced Channels Settings						
TRANS	CHANNEL NUMBER	11	12	13	14		
NUMBE	STATE	ON	OFF	OFF	OFF		
MULTI	TYPE	DPCH	DPCH	DPCH	DPCH		
ENHAF	CHAN CODE	0	0	0	0		
CODE	CODING	OFF	OFF	OFF	OFF		
CHANP	POWER START	0.0	0.0	0.0	0.0		
-CHNO-	POWER CONTROL	UP	OFF	OFF	OFF		
0	DATA	PN15	PN15	PN15	PN15		
1							
2	TPC	PATT	PATT	PATT	PATT		

- Menu **Select BS/MS: BS1**
  - BS1 ON
- Menu **WCDMA/3GPP:**
  - STATE ON

Settings on the spectrum analyzer for the channel power measurement:

- REF LEVEL as PEP at the SMIQ
  - CENTER FREQUENCY test frequency
  - POWER MEAS SETTINGS/ACP STANDARD/WCDMA-FWD,
  - CHANNEL POWER, CP/ACP ABS
- Apply a TTL high level to the LEVATT input of the SMIQ.
  - The measured channel power should be  $0 \pm 1$  dBm.
- Apply a TTL low level to the LEVATT input of the SMIQ.
  - Now the measured channel power should be  $-20 \pm 1$  dBm.

### 5.3.22 Bit Error Rate Test (Option SMIQB21)

Test setup

- Inputs and outputs of this interface are connected for the function test by means of a suitable connector (table 5-1, pos. 27).

Measurement

- Settings on SMIQ
  - UTILITIES/TEST/TEST MCODE BERT
  - ⇒ No fault messages should occur.

### 5.3.23 Fading Simulation (Option SMIQB14/SMIQB15)

The basic functioning of the module can be checked by calling up the built-in test. To do this, select UTILITIES/TEST TEST FSIM in the menu. No fault messages should occur.

#### 5.3.23.1 Frequency Response

Test equipment	<ul style="list-style-type: none"> <li>- Spectrum analyzer (Table 5-1, item 2)</li> <li>- Signal generator (Table 5-1, item 5)</li> </ul>
Test setup	<ul style="list-style-type: none"> <li>➤ Connect the RF output of the SMIQ to the spectrum analyzer and connect the signal generator to the I input of the SMIQ.</li> </ul>
Test method	<p>By applying a sinusoidal AC voltage to the I input, an amplitude modulation with suppressed carrier is generated. The fading simulator is set so that a copy of the input signal only slightly shifted in frequency is generated at its output. The amplitude modulation is maintained. The modulation frequency response is determined by measuring the sidebands as a function of the frequency of the AC voltage applied.</p>
Measurement	<ul style="list-style-type: none"> <li>➤ Settings on SMIQ:             <ul style="list-style-type: none"> <li>- Test level -10 dBm, test frequency &gt; 15 MHz; 400 MHz, 1.8 GHz, 2.5 GHz, 3.3 GHz, 4.4 GHz, and 6.4 GHz are recommended</li> <li>- Switch on vector modulation</li> <li>- Switch on fading simulation</li> <li>- Path 1 with PURE DOPPLER, 0 dB, Doppler frequency 1 Hz</li> <li>- Switch off all other paths</li> </ul> </li> <li>➤ Setting on signal generator:             <ul style="list-style-type: none"> <li>- Level 0.5 V (V<sub>peak</sub>) corresponding to 4 dBm</li> </ul> </li> <li>➤ Settings on analyzer:             <ul style="list-style-type: none"> <li>- Center frequency = test frequency,</li> <li>span = 3 times the sideband frequency</li> <li>- Reference level = test level</li> <li>- Scale 1dB/div</li> </ul> </li> <li>➤ Vary the frequency from 1 MHz to 10 MHz on the signal generator and observe the modulation sidebands on the analyzer.</li> <li>➤ For evaluation, determine the difference between the modulation sidebands and the first sideband at 1 MHz. The values of the left and the right sideband have to be averaged.             <ul style="list-style-type: none"> <li>⇒ The bandwidth is twice the modulation frequency at which -3 dB is no longer reached, with reference to 1 MHz.</li> </ul> </li> </ul>

### 5.3.23.2 Additional Modulation Frequency Response

Test equipment, setup and method as above

- Testing
- Two frequency response measurements are made, the first one with the fading simulator switched off and the second with bandwidth measurement setting.
  - ⇒ The additional frequency response is the difference between the first and second measurement.

### 5.3.23.3 Carrier Leakage for Fading

Test equipment            Spectrum analyzer (table 5-1, item 2)

- Test setup
- Connect the spectrum analyzer to the RF output of the SMIQ.
  - Terminate the I and the Q input with 50 Ω.

- Measurement
- Settings on the analyzer:  
Analyzer reference level to measurement level, span 10 kHz, RBW 300 Hz, VBW 300 Hz.
  - Settings on SMIQ
    - Measurement level -15 dBm
    - Measurement frequencies 400 MHz, 1 GHz, 2.2 GHz and 4.4 GHz
  - First measure the unmodulated level as a reference.
  - Settings on SMIQ
    - Vector modulation ON
    - Fading: 1CH, PATH 1 ON, PROFILE PDOPP, FREQ RATIO 1.0 , DOPP FREQ 1.6 kHz, PATH LOSS 0 dB, other paths OFF,
  - Now measure carrier leakage.
  - ⇒ The carrier leakage in dBc is the difference between the level of the spectral line at the carrier frequency and the reference level.

### 5.3.23.4 Path Attenuation

Test assembly            Test assembly with spectrum analyzer for fading simulation

Test method

For vector modulation, a single-sideband amplitude modulation (SSB-AM) is generated by applying a sinusoidal signal to the I input and a cosine signal to the Q input. The second sideband and the carrier are suppressed.

- Testing
- A dual-channel generator (pos. 18) is used to feed an I/Q signal to the SMIQ via the I/Q inputs. Make sure the cables are of the same length.

Settings if R&S generator ADS is to be used

Channel	CH1	CH2
Waveform	Sine	Sine
Mode	Cont	Cont
Frequency	4 MHz	4 MHz
Level	1.0 V	1.0 V
Offset	0.0 V	0.0 V
Phase	0°	-90°
Filter	OFF	OFF
Output	ON	ON

Make the following settings on SMIQ.

Frequency: 1 GHz  
 Level (PEP): 0 dBm  
 Vector mode: State: On

The quadrature of the input signals is at first set on the spectrum analyzer at a span of 20 MHz. This is necessary to compensate for small differences of cable length at the I and Q channels. Activate SYNC/PHASE at the dual-channel generator and minimize the left sideband with the phase.

Further settings on SMIQ:

Fading Sim: Configuration: 1CH\_6P or 1CH\_12P dep. on extensions  
 Mode: RUN  
 Configuration: for ref. measurement OFF, for measurement 1CH\_6P or 1CH\_12P

PATH	1	2	3	4	5	6	
STATE	ON	ON	ON	ON	ON	ON	
PROFILE	pDOPP	pDOPP	pDOPP	pDOPP	pDOPP	pDOPP	
DISCRETE COMP	OFF	OFF	OFF	OFF	OFF	OFF	
POWER RATIO							
FREQ RATIO	0.1	0.2	0.3	0.4	0.5	0.6	
SPEED							
DOPPLER FREQ	1600	1600	1600	1600	1600	1600	Hz
PATH LOSS	0.0	5.0	10.0	15.0	20.0	25.0	dB
DELAY	0.0	0.1	0.3	0.5	0.8	1.1	µs
LOGNORM STATE	OFF	OFF	OFF	OFF	OFF	OFF	
LOCAL CONST							
STD DEV							

and for 12 paths are installed

PATH	7	8	9	10	11	12	
STATE	ON	ON	ON	ON	ON	ON	
PROFILE	pDOPP	pDOPP	pDOPP	pDOPP	pDOPP	pDOPP	
DISCRETE COMP	OFF	OFF	OFF	OFF	OFF	OFF	
POWER RATIO							
FREQ RATIO	-0.1	-0.2	-0.3	-0.4	-0.5	-0.6	
SPEED							
DOPPLER FREQ	1600	1600	1600	1600	1600	1600	Hz
PATH LOSS	2.5	7.5	12.5	17.5	22.5	27.5	dB
DELAY	2.0	2.1	3.3	3.5	3.8	10.1	µs
LOGNORM STATE	OFF	OFF	OFF	OFF	OFF	OFF	
LOCAL CONST							
STD DEV							

- The result is a spectrum consisting of carrier leakage, image-frequency bands and the sought spectrum. The line of a channel is offset by the  $\text{DOPPLER FREQ} * \text{FREQ RATIO}$  with reference to the theoretical, undistorted line at the distance of the I/Q input frequency (in this case 1004 MHz).
- The spectrum analyzer is used to measure the RF output spectrum of the SMIQ. Recommended settings:  
CENTER 1004 MHz, SPAN 3 kHz, COUPLING RATIO SPAN/RBW 100

Nominal values for the individual paths:

path	delta f to line at CONF. OFF	relative level/dB	tolerance
1	160	-1.65 6 paths, -3.58 12 paths	0.5 dB
2	320	-5	0.3 dB with reference to 1st path
3	480	-10	
4	640	-15	
5	800	-20	
6	960	-25	0.4 dB

If 12 paths are installed:

path	delta f	relative level/dB	tolerance
7	-160	-2.5	0.3 dB with reference to 1st path
8	-320	-7.5	
9	-480	-12.5	
10	-640	-17.5	
11	-800	-22.5	0.4 dB
12	-960	-27.5	0.5 dB

- The image-frequency band at 996 MHz should be suppressed >40 dB compared to the useful band at 1004 MHz.
- There is another image-frequency band at the carrier (i.e. at 1000 MHz), which should also be suppressed >40 dB. (Note: this requires an offset-free modulation signal.)



### 5.3.23.5 Path Delay (optional)

Preliminary remark	Since the delay between various paths of the fading simulator is implemented fully digitally, a test is not necessarily required. The required setting accuracy is guaranteed by the digital hardware and software design.
Test assembly	Test assembly with sampling oscilloscope for fading simulation connected to the outputs I-FADED and Q-FADED. For accurate checking of compliance with data sheet specifications, the oscilloscope must have a sampling rate of at least 500 Msamples/s.
Test method	With vector modulation and fading simulation switched on, a periodic pulse signal with short pulses is applied to the I input of the SMIQ. The fading simulator is set so that two transmission paths with different delays are available. As a result, two echoes of the pulse signal are obtained. The accuracy of the set path delay is checked by measuring the delay between the echoes at the output of the fading simulators.
Measurement	<ul style="list-style-type: none"><li>➤ Settings on SMIQ:<ul style="list-style-type: none"><li>- Test level –10 dBm</li><li>- Switch on vector modulation</li><li>- Switch on fading simulation</li><li>- Path 1 with PURE DOPPLER, 0 dB, 0 <math>\mu</math>s, frequ. ratio 0</li><li>- Path 2 with PURE DOPPLER, 0 dB, 1 <math>\mu</math>s, frequ. ratio 0</li><li>- Other paths are switched off</li></ul></li><li>➤ Settings on ARB generator:<ul style="list-style-type: none"><li>- Level 0.5 V (Vpeak)</li><li>- Channel 1 pulse signal with 100 ns switch-on time, 2.6 <math>\mu</math>s switch-off time</li></ul></li><li>➤ Setting on sampling oscilloscope<ul style="list-style-type: none"><li>- Time interval 2 <math>\mu</math>s</li></ul></li><li>➤ Measure the time difference between the two pulse signals at the I or Q output of the fading simulator using the oscilloscope.<ul style="list-style-type: none"><li>⇒ The measured time difference (rising edge) must be equal to the difference between the set path delays.</li></ul></li></ul>

### 5.3.23.6 Doppler Shift (optional)

Preliminary remark	Because the Doppler shift is fully digital in the fading simulator, no checking is required if the path attenuation has been successfully measured. The digital hardware and software ensures setting accuracy.
Test set	Test set with spectrum analyzer for fading simulation; if the analyzer has no counter function, a frequency counter (table 5-1, pos. 1) has to be used.
Test method	<p>For vector modulation, a single-sideband amplitude modulation (SSB-AM) is generated by applying a sinusoidal signal to the I input and a cosine signal to the Q input. The second sideband and the carrier are suppressed.</p> <p>The fading simulator is set so that only a single transmission path with a constant amplitude is available. With a Doppler shift set, the output frequency is shifted by the set Doppler frequency. The accuracy of the setting is checked by measuring the output frequency for various settings of the Doppler frequency.</p>
Measurement	<ul style="list-style-type: none"><li>➤ Settings on SMIQ:<ul style="list-style-type: none"><li>- Test level –10 dBm, test frequency 1GHz</li><li>- Switch on vector modulation</li><li>- Set fading simulation</li><li>- Path 1 with PURE DOPPLER, 0 dB</li><li>- Doppler frequencies 0.1/0.2/0.5/1 kHz</li><li>- Other paths are switched off</li></ul></li><li>➤ Settings on ARB generator:<ul style="list-style-type: none"><li>- Level 0.5 V (V<sub>peak</sub>)</li><li>- Channel 1 sinusoidal signal 10 kHz</li><li>- Channel 2 cosine signal (90° phase rel. to channel 1), 10 kHz</li></ul></li><li>➤ Measure output frequency using the frequency counter. At first the reference frequency is measured with fading switched off, then the shifted frequencies with fading switched on.<ul style="list-style-type: none"><li>⇒ The differences to the reference frequency determine the Doppler frequencies.</li></ul></li></ul>

### 5.3.24 Noise Generation and Distortion Simulation (Option SMIQB17)

The basic functioning of the module can be checked by calling up the built-in test. To do this, select UTILITIES/TEST TEST NDSIM in the menu. No fault messages should occur.

#### 5.1.1.1 RF Bandwidth

Test equipment	<ul style="list-style-type: none"> <li>- Spectrum analyzer (table 5-1, pos. 2)</li> <li>- Test transmitter (table 5-1, pos. 5)</li> </ul>
Test setup	<ul style="list-style-type: none"> <li>➤ Connect the RF output of the SMIQ to the spectrum analyzer and the signal generator to the I input of the SMIQ.</li> </ul>
Test method	<p>A sinusoidal AC voltage is fed to the I input, which leads to the generation of an amplitude modulation with carrier suppression. The fading simulator is set such an image of the input signal is generated at its output with a frequency that is only minimally offset. Amplitude modulation is retained. Modulation frequency response is determined by measuring the sidebands with reference to the frequency of the fed AC voltage.</p>
Measurement	<ul style="list-style-type: none"> <li>➤ Settings on SMIQ             <ul style="list-style-type: none"> <li>- Measurement level 0 dBm</li> <li>- Measurement frequencies 400 MHz, 1.472 GHz, 2.2 GHz 4.4 GHz and 6.4 GHz</li> <li>- Switch on vector modulation</li> <li>- Switch on DISTORTION CHARACTERISTIC TEST.</li> </ul> </li> <li>➤ Setting on test transmitter             <ul style="list-style-type: none"> <li>- Level 0.5 V (V<sub>peak</sub>) in line with 4 dBm.</li> </ul> </li> <li>➤ Settings on analyzer             <ul style="list-style-type: none"> <li>- Center frequency = measurement frequency, span = three times sideband frequency</li> <li>- Reference level = measurement level</li> <li>- Scale 1 dB/div.</li> </ul> </li> <li>➤ Adjust frequency between 1 MHz and 10 MHz at the signal generator and observe modulation sidebands on the analyzer.</li> <li>➤ Determine difference between modulation sidebands and the first sideband at 1 MHz. For the left and right sidebands, average values have to be taken.             <ul style="list-style-type: none"> <li>⇒ The bandwidth is twice the modulation frequency at which -3 dB is no longer reached, with reference to 1 MHz.</li> </ul> </li> </ul>
Test setup	<ul style="list-style-type: none"> <li>➤ Connect test transmitter to Q input of the SMIQ.</li> <li>➤ Terminate I input with 50Ω.</li> </ul>
Measurement	<ul style="list-style-type: none"> <li>➤ As above for I input.</li> </ul>

### 5.3.24.2 Additional Modulation Frequency Response

Test equipment, test setup and test method as above

- |             |  |
|-------------|--|
| Measurement | <ul style="list-style-type: none"> <li>➤ Two frequency response measurements are performed, the first one with DISTORTION OFF, the second with the bandwidth measurement setting.</li> <li>⇒ The additional frequency response sought is the difference between the first and second measurement.</li> </ul> |
| Test setup  | <ul style="list-style-type: none"> <li>➤ Connect signal generator to the Q input of the SMIQ.</li> <li>➤ Terminate the I input with 50 Ω.</li> </ul>   |
| Measurement | <ul style="list-style-type: none"> <li>➤ As above for I input.</li> </ul>  |

### 5.3.24.3 Residual Carrier

- |                |  |
|----------------|--|
| Test equipment | Spectrum analyzer (Table 5-1, item 2)  |
| Test setup     | <ul style="list-style-type: none"> <li>➤ Connect the spectrum analyzer to the RF output of the SMIQ.</li> <li>➤ Terminate the I and the Q input with 50 Ω.</li> </ul>  |
| Measurement    | <ul style="list-style-type: none"> <li>➤ Settings on SMIQ:             <ul style="list-style-type: none"> <li>- Test level 0 dBm</li> <li>- Test frequency 400 MHz, 1.472 GHz and 4.4 GHz</li> <li>- DISTORTION CHARACTERISTIC LIST                 <ul style="list-style-type: none"> <li>Switch on SELECT LIST...TEST,</li> <li>DISTORTION ON</li> </ul> </li> <li>- Select OFF in the menu VECTOR MOD/STATE</li> </ul> </li> <li>➤ Settings on analyzer:             <ul style="list-style-type: none"> <li>- Center frequency = test frequency, span = 1 MHz</li> <li>- Reference level = test level</li> <li>- Scale 10 dB/div</li> </ul> </li> <li>➤ First measure the unmodulated level as a reference.</li> <li>➤ Switch on vector modulation (STATE ON) and measure the residual carrier.             <ul style="list-style-type: none"> <li>⇒ The residual carrier in dBc is the level of the residual signal found referred to the output signal of the DUT without modulation (dBc = referred to the carrier). This value must be about the typical value (&lt;-35 dBc) to ensure that the C/N values are maintained.</li> </ul> </li> </ul> |

#### 5.3.24.4 Frequency Response through to I-FADED, Q-FADED Outputs

Test equipment	<ul style="list-style-type: none"> <li>- Spectrum analyzer (Table 5-1, item 2)</li> <li>- Signal generator (Table 5-1, item 5)</li> </ul>
Test setup	<ul style="list-style-type: none"> <li>➤ Connect the signal generator to the I input of the SMIQ. Connect the I-FADED output on the rear panel of the SMIQ to the spectrum analyzer.</li> <li>➤ Terminate the Q input with 50 Ω.</li> </ul>
Test method	By applying a sinusoidal AC voltage to the I input, a sinusoidal signal will be obtained at the I-FADED output whose level can be measured with the spectrum analyzer.
Measurement	<ul style="list-style-type: none"> <li>➤ Settings on SMIQ:             <ul style="list-style-type: none"> <li>- Switch on vector modulation</li> <li>- Switch on DISTORTION CHARACTERISTIC TEST</li> </ul> </li> <li>➤ Setting on signal generator:             <ul style="list-style-type: none"> <li>- Level 0.5 V (V<sub>peak</sub>) corresponding to 4 dBm</li> </ul> </li> <li>➤ Settings on analyzer:             <ul style="list-style-type: none"> <li>- Start frequency = 0 MHz</li> <li>- Stop frequency = 5 MHz</li> </ul> </li> <li>➤ Vary the frequency from 0.1 MHz to 5 MHz on the signal generator and measure the level.             <ul style="list-style-type: none"> <li>⇒ The frequency response is the difference between the highest and the lowest level.</li> </ul> </li> </ul>
Test setup	<ul style="list-style-type: none"> <li>➤ Connect the Q-FADED output on the rear panel of the SMIQ to the spectrum analyzer, connect the signal generator to the Q input of the SMIQ.</li> <li>➤ Terminate the I input with 50 Ω.</li> </ul>
Measurement	Same as for I input above.

### 5.3.24.5 Signal/Noise Ratio (Carrier/Noise Ratio)

Test equipment	RF spectrum analyzer (table 5-1, pos. 2).
Test setup	➤ Connect analyzer to RF output of the SMIQ.
Test method	<p>Since carrier signal (C) and noise signal (N) are superimposed, a menu has been generated with <code>:UTILITIES:DIAG:CN/MEAS</code> in which either the carrier signal or the noise signal alone can be switched on.</p> <p>To determine the carrier/noise ratio, carrier power N is measured by integration of the power density over the system bandwidth with noise switched on, and carrier power C by integration of the power density over the channel bandwidth with carrier switched on.</p> <p>Integration is performed by the RF analyzer (table 5-1, pos. 2), using marker functions CHANNEL POWER.</p> <p><math>C/N[\text{dB}] = C[\text{dBm}] - N[\text{dBm}]</math> is calculated from <math>C[\text{dBm}]</math> and <math>N[\text{dBm}]</math>.</p>
Test procedure	<ul style="list-style-type: none"> <li>➤ Set the test parameters on the SMIQ. Peak envelope power PEP cannot be entered directly since it is calculated from the settings for modulation and noise. However, a trial setting can be made, e.g. <code>-50 dBm</code>, to determine the difference between PEP and LEVEL, which renders a new level setting with the desired peak power PEP.</li> <li>➤ On analyzer: <ul style="list-style-type: none"> <li>set the reference level to peak power PEP, span to 1.2 times the channel bandwidth,</li> <li>select marker function MARKER NORMAL / CHANNEL POWER and set it to the required channel bandwidth.</li> <li>Switch on RMS detector and select a sweep time of 2 s.</li> </ul> </li> <li>➤ Select <code>UTILITIES:DIAG:CN/MEAS CARRIER</code> in the SMIQ menu to generate the carrier alone.</li> <li>➤ Now the channel power can be measured.</li> <li>➤ Select the SMIQ setting <code>UTILITIES:DIAG:CN/MEAS NOISE</code> to generate the noise signal alone.</li> <li>➤ On analyzer: <ul style="list-style-type: none"> <li>set voltage to approx. 1.2 times the system bandwidth and CHANNEL POWER to the system bandwidth required.</li> </ul> </li> <li>➤ Now the noise power can be measured. <ul style="list-style-type: none"> <li>⇒ The C/N in dB is the difference between the channel power in dBm and noise power in dBm.</li> </ul> </li> </ul>

## Measurements

- Settings on SMIQ:  
FREQ 1.472 GHz  
LEVEL -10 dBm  
NOISE/DIST NOISE ON  
CARRIER/NOISE RATIO 10 dB  
SYSTEM BANDWIDTH 1 MHz
- Measure C/N with channel bandwidth and system bandwidth 1 MHz.
  
- Settings on SMIQ:  
FREQ 1.472 GHz  
VECTOR MOD: STATE: ON  
Apply full-scale level (0.500 V) to I input,  
NOISE/DIST: NOISE: ON  
: CARRIER / NOISE: -24, -5,4 and 20 dB  
: SYSTEM BANDWIDTH: 10 kHz, 100kHz, 1 MHz and 10 MHz  
LEVEL: 0 dBm (PEP)  
Measure C/N with channel bandwidth = system bandwidth.
  
- Settings on SMIQ: FREQ 1.472 GHz  
Digital modulation 2FSK with  
DEVIATION 300 kHz  
FILTER GAUSS 0.3  
Switch on symbol rate 300 kHz.  
Noise with C/N = 10 dB  
Switch on SYSTEM BANDWIDTH = 1.2 MHz.  
LEVEL 0 dBm (PEP)
- Measure C/N with channel bandwidth and system bandwidth 1.2 MHz.
  
- Settings on SMIQ:  
FREQ 1.472 GHz  
Switch on digital modulation QPSK.  
Symbol rate 3.6 M  
Noise WITH C/N = 10 dB  
Switch on SYSTEM BANDWIDTH 5 MHz.  
Measurement level 0 dBm (PEP)
- Measure C/N with channel bandwidth and system bandwidth 5 MHz.

### 5.3.24.6 Signal/Noise Ratio (Carrier/Noise Ratio) Worldspace

Test equipment	See above
Test setup	See above
Test method	See above
Measurement	<ul style="list-style-type: none"> <li>➤ Settings on SMIQ:           <ul style="list-style-type: none"> <li>LEVEL -15 dBm</li> <li>FREQ 1.472 GHz</li> <li>Switch on digital modulation standard WORLDSPACE.</li> <li>Switch on filter mode LOW_EVM.</li> <li>Data source PRBS</li> <li>Switch on noise with C/N = -5 dB / 4 dB / 20 dB and SYSTEM BANDWIDTH = 1.84 MHz.</li> </ul> </li> <li>➤ Measure C/N with channel bandwidth and system bandwidth 1.84 MHz.</li> <li>➤ Repeat all measurements with DISTORTION ON, LIST TWTA.</li> </ul>

### 5.3.24.7 Error Vector

Test equipment	Demodulator for digital modulation (Table 5-1, item 23)
Measurement	<ul style="list-style-type: none"> <li>➤ Settings on SMIQ:           <ul style="list-style-type: none"> <li>- Test level <math>P_{vm_{max}}</math> (PEP)</li> <li>- Test frequency 1.472 GHz and frequencies according to Table 5-2</li> <li>- Switch on digital modulation standard WORLDSPACE</li> <li>- Switch on filter mode LOW_EVM</li> <li>- Data source PRBS</li> <li>- Switch on DISTORTION CHARACTERISTIC TEST</li> </ul> </li> <li>➤ Settings on demodulator:           <ul style="list-style-type: none"> <li>- QPSK modulation</li> <li>- Symbol rate = 1.84 Msym/s</li> <li>- Filter: SQR COS 0.4</li> <li>- Reference level = <math>P_{vm_{max}} + 3</math> dBm</li> <li>- Evaluation over 150 symbols</li> <li>- 10 averaging procedures</li> </ul> </li> <li>➤ Measure the error vector magnitude (rms) on the demodulator.</li> </ul>



### 5.3.24.8 Noise Frequency Response

Test equipment	Spectrum analyzer (Table 5-1, item 2)
Test setup	<ul style="list-style-type: none"><li>➤ Connect the spectrum analyzer to the RF output of the SMIQ.</li><li>➤ Terminate the I and the Q input with 50 Ω.</li></ul>
Measurement	<ul style="list-style-type: none"><li>➤ Settings on SMIQ:<ul style="list-style-type: none"><li>- Test level -10 dBm</li><li>- Test frequency 1.472 GHz</li><li>- Set Noise/Disto CARRIER/NOISE RATIO 4 dB and SYSTEM BANDWIDTH 1.84 MHz</li><li>- Select ON in the menu VECTOR MOD/STATE</li></ul></li><li>➤ Settings on analyzer:<ul style="list-style-type: none"><li>- Center frequency = test frequency, span = 5 MHz</li><li>- Reference level = -25 dBm</li><li>- Scale 1 dB/div</li><li>- RBW 100 kHz, VBW 5 Hz</li></ul><p>⇒ The frequency response is the difference between maximum and minimum level within the measurement bandwidth.</p></li><li>➤ Measure the frequency response of the noise signal between the test frequency -1290 kHz and the test frequency +1290 kHz.</li><li>➤ Setting on SMIQ:<ul style="list-style-type: none"><li>- Set Noise/Disto SYSTEM BANDWIDTH 10 MHz</li></ul></li><li>➤ Settings on analyzer:<ul style="list-style-type: none"><li>- Center frequency = test frequency, span 20 MHz</li><li>- RBW 500 kHz, VBW 5 Hz</li></ul></li><li>➤ Measure the frequency response of the noise signal between the test frequency -5000 kHz and the test frequency +5000 kHz.</li></ul>

### 5.3.25 Arbitrary Waveform Generator (ARB, Option SMIQB60)

#### 5.3.25.1 Frequency Response

Test equipment	RF spectrum analyzer (Table 5-1, item 2) PC with WinIQSIM version 3.30 or higher and IEEE/IEC bus connection to the SMIQ
Test setup	➤ Connect spectrum analyzer to I/Q socket on front panel of the SMIQ.
Measurement	<ul style="list-style-type: none"> <li>➤ Settings on spectrum analyzer           <ul style="list-style-type: none"> <li>- LEVEL REF 0.0 dBm</li> <li>- START FREQUENCY 0 Hz</li> <li>- STOP FREQUENCY 20 MHz</li> </ul> </li>   <li>➤ Settings in WinIQSIM           <ul style="list-style-type: none"> <li>- File -&gt; New -&gt; Multi Carrier           Ok</li> <li>- Carrier Settings               <ul style="list-style-type: none"> <li>- No. of Carriers                           37</li> <li>- Carrier Spacing                       1000</li> <li>- CW only Mode</li> <li>- Channel Definition -&gt; to ch.       30</li> <li>- Accept</li> <li>- Channel Definition -&gt; to ch.       18</li> <li>- Channel Definition -&gt; State       OFF</li> <li>- Accept</li> </ul> </li> <li>- Ok               <ul style="list-style-type: none"> <li>At present the frequency spacing is 1 MHz from 1 MHz to 12 MHz.</li> </ul> </li> <li>- SMIQ(ARB) -&gt; Transmission...</li> <li>- ARB Waveform -&gt; Waveform Name "ARBTEST"</li> <li>- Select</li> <li>- Transmit               <ul style="list-style-type: none"> <li>At present the waveform is in the SMIQ.</li> </ul> </li> </ul> </li>   <li>➤ Settings on SMIQ           <ul style="list-style-type: none"> <li>- ARB MOD -&gt; SELECT WAVEFORM... -&gt; WAVEFORM... "ARBTEST"</li> <li>- ARB MOD -&gt; STATE                   ON</li> </ul> </li>   <li>➤ Test procedure           <ul style="list-style-type: none"> <li>- Marker to 1 MHz</li> <li>- Delta Marker to 12 MHz</li> <li>- The read level difference is the frequency response.</li> <li>- Perform same measurement for I and Q</li> </ul> </li> </ul>

### 5.3.25.2 DC Voltage Offset

- Test setup ➤ Connect AC/DC voltmeter to I/Q socket on front panel of the SMIQ.
- Measurement of DC voltage offset ➤ Measurement sequence
- Switch on 100 Hz input lowpass of voltmeter.
  - Measure DC voltage at I =  $U_I$
  - Measure DC voltage at Q =  $U_Q$
  - Calculate offset:

$$Offset = 20 \cdot \log \left( \frac{1.0V}{\sqrt{U_I^2 + U_Q^2}} \right)$$

Perform same measurement for I and Q.

### 5.3.25.3 Spurious-Free Dynamic Range (SFDR)

Test equipment RF spectrum analyzer (Table 5-1, item 2)  
PC with WinIQSIM version 3.30 or higher and IEEE/IEC bus connection to the SMIQ.

Test setup ➤ Connect spectrum analyzer to I/Q socket on front panel of the SMIQ.

- Measurement ➤ Settings on spectrum analyzer
- LEVEL REF 10.0 dBm
  - START FREQUENCY 0 Hz
  - STOP FREQUENCY 20 MHz
- Settings in WinIQSIM
- File -> New -> Multi Carrier Ok
  - Carrier Settings
    - No. of Carriers 3
    - Carrier Spacing 1000
    - CW only Mode
    - Channel Definition -> to ch. 1
    - Channel Definition -> State OFF
    - Accept
  - Ok
  - At present there is a sinewave of 1 MHz for I and Q.
  - SMIQ(ARB) -> Transmission...
  - ARB Waveform -> Waveform Name „ARBTEST“
  - Select
  - Transmit
  - At present the waveform is in the SMIQ.
- SMIQ
- ARB MOD -> SELECT WAVEFORM... -> WAVEFORM... „ARBTEST“
  - ARB MOD -> STATE ON
- Test procedure
- Marker to 1 MHz
  - Delta marker to maximum spurious (0 to 12 MHz).
  - Read SFDR
  - Perform same measurement for I and Q

### 5.3.25.4 Level Difference of Channels

Test equipment	AC/DC voltmeter (Table 5-1, item 19) PC with WinIQSIM version 3.30 or higher and IEEE/IEC bus connection to the SMIQ.
Test setup	➤ Connect AC/DC voltmeter to I/Q socket on front panel of the SMIQ.
Measurement	<p>➤ Settings on AC/DC voltmeter</p> <ul style="list-style-type: none"> <li>- Mode AC</li> <li>- Unit V</li> </ul> <p>➤ Settings in WinIQSIM</p> <ul style="list-style-type: none"> <li>- File -&gt; New -&gt; Multi Carrier                   Ok</li> <li>- Carrier Settings</li> <li>- No. of Carriers                                       3</li> <li>- Carrier Spacing                                     1</li> <li>- CW only Mode</li> <li>- Channel Definition -&gt; to ch.                   1</li> <li>- Channel Definition -&gt; State                   OFF</li> <li>- Accept</li> <li>- Ok</li> </ul> <p>At present there is a sinewave of 1 MHz for I and Q.</p> <ul style="list-style-type: none"> <li>- SMIQ(ARB) -&gt; Transmission...</li> <li>- ARB Waveform -&gt; Waveform Name "ARBTEST"</li> <li>- Select</li> <li>- Transmit</li> </ul> <p>At present the waveform is in the SMIQ.</p> <p>➤ SMIQ settings</p> <ul style="list-style-type: none"> <li>- ARB MOD -&gt; SELECT WAVEFORM... -&gt; WAVEFORM... "ARBTEST"</li> <li>- ARB MOD -&gt; STATE                           ON</li> </ul> <p>➤ Test procedure</p> <ul style="list-style-type: none"> <li>- Read RMS voltage on I                       = <math>U_I</math></li> <li>- Read RMS voltage on Q                       = <math>U_Q</math></li> <li>- Calculate level difference:</li> </ul> $\text{Level difference} = \frac{ U_Q - U_I }{U_I} \cdot 100\%$

### 5.3.26 Additional Measurements for SMIQ03S

SMIQ03S is a variant of SMIQ03B for the XM-radio project. In addition to basic unit SMIQ03B, the following modules are installed:

- Data Generator SMIQB11 with large memory (SMIQB12)
- Modulation Coder SMIQB20
- COFDM Coder 2072.6895.10 model 10.

All test specifications for SMIQ03B are applicable, the measurements described here are to be performed in addition.

Test equipment and setup      Connect spectrum analyzer (Table 5-1, item 2) to the RF socket of the SMIQ.

- Measurement
- Settings on SMIQ
    - Carrier frequency 2337.490 MHz
    - Level 0dBm
    - Digital standard XM, State On
    - Mode:                    terrestrial
    - Select list terrestrial:        TERR
    - Symbol Gain:        0 (384 dB < firmware version 5.30)
    - Preamble Gain:        0 (32 dB < firmware version 5.30)
    - Trigger Mode:        Auto
    - Then:
    - Utilities -> DIAG -> COFDM -> MCM: ON
    - (a stable spectrum is obtained with the last setting)
  - Settings on analyzer
    - Center: 2337.490 MHz
    - Span: 20 MHz
    - Ref Level: 0 dBm
    - RBW: 3 kHz
    - VBW: 3 kHz
    - Sweep Time: 5.6 s
    - Detector RMS
    - RF Atten 20 dB (important!)

- Checking the spectral mask      ➤ Check the generated spectrum according to the following table using the DELTA MARKER function:

Spacing to carrier frequency	Minimum level	Maximum level
-20 MHz		- 50 dBc
-2 MHz		- 33 dBc
-1.35 MHz		- 30 dBc
-1.2 MHz	-0.5 dBc	+0.2 dBc
+1.2 MHz	-0.5 dBc	+0.2 dBc
+1.35 MHz		-30 dBc
+2 MHz		-33 dBc
+20 MHz		-50 dBc

Example of a measurement:

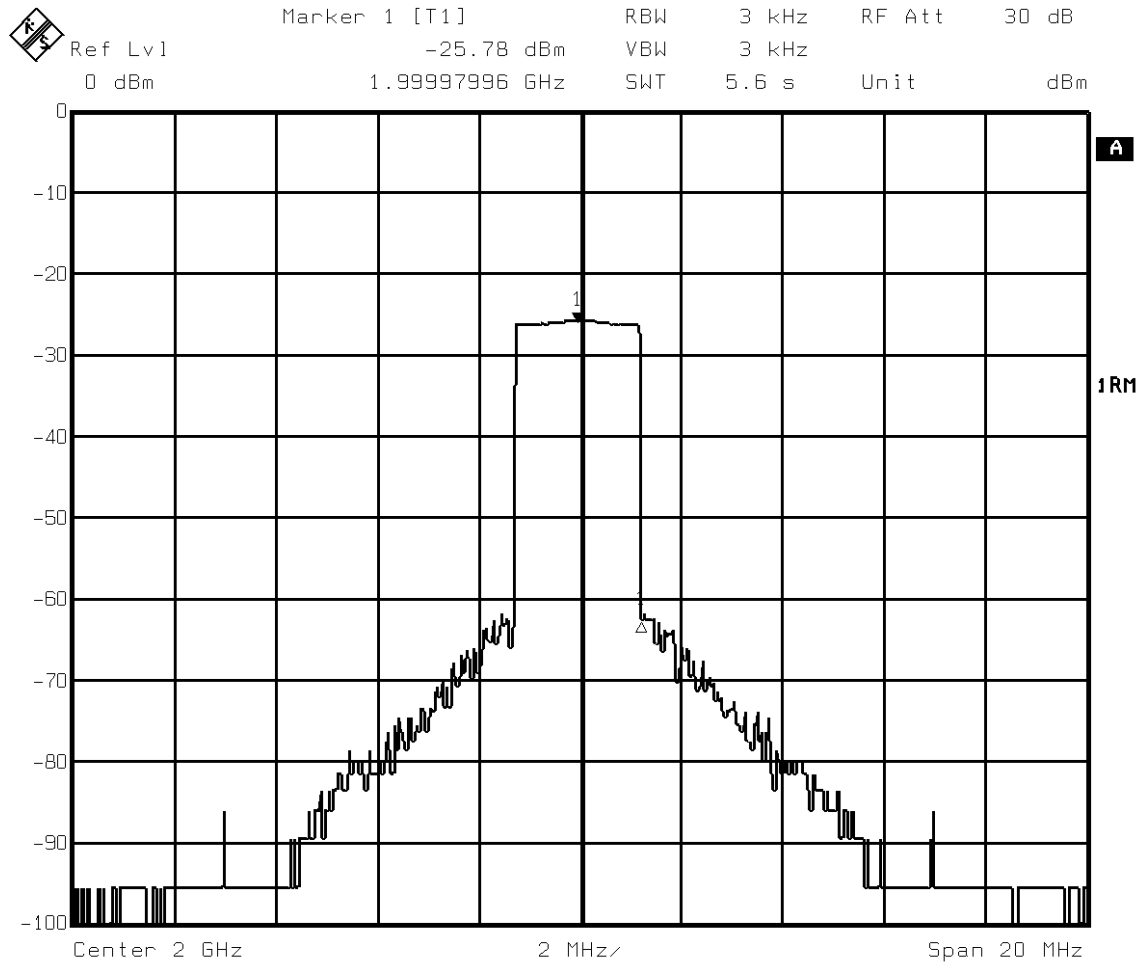

Date: 23.FEB.2000 11:02:56

## 5.4 Performance Test Report

ROHDE&SCHWARZ	VECTOR SIGNAL GENERATOR SMIQ02B/03B/04B/06B	1125.5555.02/03/04/06
Serial number:		
Person testing:		
Date:		
Signature:		

For nominal data and limit values refer to the data sheet supplied with the instrument.

Section	Characteristic	Min.	Actual	Max.	Unit
5.3.1	Display and keyboard	O.K.			-
5.3.2.1	Frequency setting	O.K.			-
5.3.2.2	Setting time CW VM, ALC TABLE				ms ms
5.3.2.3	Setting time LIST MODE				µs
5.3.3	Reference frequency, output level Reference frequency, drift, input for external reference	O.K.			V Hz -
5.3.4.1	Frequency response at reference level with ALC OFF Level, total error for RF <=2.5 GHz RF >2.5 GHz				dB dB dB dB
5.3.4.2	Output impedance (VSWR) at max. level, lower frequency range at max. level, upper frequency range at low level, lower frequency range at low level, upper frequency range				- - - -
5.3.4.3	Setting time (IEC/IEEE bus) CW, analog modulation, with mechanical attenuator without mechanical attenuator				ms ms
5.3.4.4	Non-interrupting level setting Attenuator fixed 5 dB Attenuator fixed 10 dB Attenuator fixed 15 dB Attenuator fixed 20 dB Attenuator electronic 35 dB Attenuator electronic 70 dB Attenuator electronic 80 dB	4.85 9.7 14.2 17.5 34.0 68.5 77.5		5.15 10.3 15.8 22.5 36.0 71.5 82.5	dB dB dB dB dB dB dB
5.3.4.5	Overvoltage protection DC test RF test	O.K. O.K.			
5.3.5.1	Harmonics suppression				dBc

Section	Characteristic	Min.	Actual	Max.	Unit
5.3.5.2	Spurious, CW, offset >10 kHz				
5.3.5.3	0.3 MHz to 450 MHz				dBc
	> 450 MHz to 1500 MHz				dBc
	> 1500 MHz to 3040 MHz				dBc
	> 3040 MHz to 3300 MHz				dBc
	Offset 10 kHz to < 900 MHz				
	> 3300 MHz to 6000 MHz				dBc
	> 6000 MHz				dBc
	Offset $\geq$ 900 MHz, > 3300 MHz				dBc
	Vector modulation, offset 10 kHz to < 300 MHz				
	0.3 MHz to 3300 MHz				dBc
	Offset $\geq$ 300 MHz				
	0.3 MHz to 3300 MHz				dBc
	Offset 10 kHz to < 900 MHz				
	> 3300 MHz to 6000 MHz				dBc
	> 6000 MHz				dBc
	Offset $\geq$ 900 MHz, > 3300 MHz				dBc
5.3.5.4	Broadband noise with CW				
	RF > 20 MHz to 450 MHz				dBc
	RF > 450 MHz to 3040 MHz				dBc
	RF > 3040 MHz to 3300 MHz				dBc
	RF > 3300 MHz to 6400 MHz				dBc
5.3.5.4	Broadband noise with vector mod., RF>20 MHz				dBc
5.3.5.5	SSB phase noise, at 20 kHz offset, with CW, at RF 400 MHz				
	1 GHz				dBc(1Hz)
	2 GHz				dBc(1Hz)
	3 GHz				dBc(1Hz)
	6 GHz				dBc(1Hz)
	with vector modulation, at RF 400 MHz				
	1 GHz				dBc(1Hz)
	2 GHz				dBc(1Hz)
	3 GHz				dBc(1Hz)
	6 GHz				dBc(1Hz)
5.3.5.6	Residual FM, rms, at 1 GHz				
	0.3 to 3 kHz (ITU-T)				Hz
	0.02 to 23 kHz				Hz
5.3.5.7	Residual AM, rms (0.02 to 23 kHz)				%
5.3.6	Sweep				
	X-AXIS	O.K.			
	MARKER	O.K.			
	BLANK	O.K.			
5.3.7	Internal modulation generator				
	Frequency drift				-
	Frequency response up to 100 kHz				dB
	up to 1 MHz				dB
	Distortion				%
	Output voltage				
	3 mV				mV
	10 mV				mV
	30 mV				mV
	100 mV				mV
	1 V				V
	2 V				V
	4 V				V



Section	Characteristic	Min.	Actual	Max.	Unit
5.3.8	Vector modulation Input impedance I Input impedance Q Max. level Error vector rms value peak value Modulation frequency response Residual carrier 0% Residual carrier 10% Imbalance (I≠Q) Quadrature error POW RAMP level error POW RAMP on/off ratio Delay time Rise time Fall time				- - dB % % dB dBc dBc  dB dB μs μs μs
5.3.9	Amplitude modulation Modulation depth, setting error Distortion with AM 30% with AM 80% Frequency response, RF > 5 MHz RF ≤ 5 MHz Incidental PhiM				% % % dB dB rad
5.3.9.5	Level monitoring EXT1 lower limit upper limit				V V
5.3.10	Broadband AM Modulation frequency response 10 MHz 30 MHz				dB dB
5.3.11	Pulse modulation On/off ratio Rise time Fall time Pulse delay				dB μs μs μs
5.3.12.1	FM deviation setting at 300 Hz at 1 kHz at 3 kHz at 10 kHz at 30 kHz at 100 kHz at 250 kHz at 500 kHz				Hz kHz kHz kHz kHz kHz kHz kHz
5.3.12.2	FM distortion				%
5.3.12.3	FM frequency response EXT1 10 Hz to 100 kHz EXT2 10 Hz to 100 kHz EXT1 10 Hz to 2 MHz EXT2 10 Hz to 2 MHz INT 10 Hz to 100 kHz INT 10 Hz to 1MHz  FM preemphasis, deviation error 50 μs 75 μs				dB dB dB dB dB dB  % %
5.3.12.5	Residual AM with FM				%
5.3.12.6	Frequency offset with FM Deviation 0 Hz Deviation 200 Hz				Hz Hz
5.3.12.7	Level monitoring EXT2 lower limit upper limit				V V

Section	Characteristic	Min.	Actual	Max.	Unit
5.3.13.1	PhiM deviation setting at 30 mrad at 0.1 rad at 0.3 rad at 1.0 rad at 3.0 rad at 10 rad				mrad rad rad rad rad rad
5.3.13.2	PhiM distortion				%
5.3.13.3	PhiM frequency response EXT1 EXT2 INT				dB dB dB
5.3.14	Digital modulation Level error Residual carrier Analog outputs ASK modulation depth error 2FSK, shift error 4FSK, shift error GFSK, shift error GMSK, phase error rms peak Error vector, rms, for PSK, 1 ksymbol/s PSK, 18 ksymbol/s PSK, 192 ksymbol/s PSK, 1500 ksymbol/s PSK, 3000 ksymbol/s QAM, 1000 ksymbol/s QAM, 3000 ksymbol/s	ok		-50	dB dB % % % % degree degree % % % % % % %
5.3.15	Function check of data generator	O.K.			
5.3.16	Digital standards GSM, Power vs. time phase error rms peak Transient spectrum Modulation spectrum EDGE error vector rms DECT, Deviation error Burst on/off NADC, error vector, rms ACP 30 kHz ACP 60 kHz ACP 90 kHz TETRA, error vector, rms ACP 25 kHz ACP 50 kHz PDC, error vector, rms ACP 50 kHz ACP 100 kHz PHS, error vector, rms ACP 600 kHz ACP 900 kHz	O.K.  O.K. O.K.			rad rad  % % dB % dBc dBc dBc % dBc dBc % dBc dBc % dBc dBc
5.3.17	IS95 CDMA (SMIQB42), rho factor reverse link forward link ACP reverse link ACP forward link				dBc dBc dBc  dBc dBc dBc

Section	Characteristic	Min.	Actual	Max.	Unit
5.3.18	W-CDMA (SMIQB43), error vector ACP 5 MHz ACP 10 MHz				% dBc dBc
5.3.19	3GPP W-CDMA (B45, 1 code channel), Error vector ACP 5 MHz ACP 10 MHz W-CDMA (B45, test model 1, 64 DPCH), ACP 5 MHz ACP 10 MHz				% dBc dBc  dBc dBc
<b>5.3.20</b>	3GPP W-CDMA (SMIQB48) Channel power at high Channel power at low				dBm dBm
5.3.22	Bit error rate test	O.K.			
5.3.23	Fading simulation Bandwidth Additional modulation frequency response Carrier leakage for fading Path attenuation Path delay (optional) Doppler shift (optional)				MHz dB dBc dB ns %
5.3.24	Noise generation and distortion simulation RF Bandwidth Additional modulation frequency response Residual carrier Frequency resp. up to I-FADED, Q-FADED Carrier/noise ratio unmodulated with vector modulation with 2FSK modulation with QPSK modulation with WorldSpace standard Error vector Noise frequency response 1.29 MHz Noise frequency response 5 MHz				Hz dB dBc dB  dB dB dB dB dB % dB dB
5.3.25	ARB MOD SMIQB60 Frequency response up to 12 MHz Spurious-Free Dynamic Range, sine wave 1 MHz to 12 MHz Level difference of channels, sine wave 1 kHz Offset in Normal mode				dB  dB  % dB
5.3.26	Additional measurements for SMIQ03S	O.K.			

## A Annex A

### A.1 IEC/IEEE Bus Interface

The instrument is equipped with an IEC/IEEE-bus connection as a standard. The mating connector according to IEEE 488 is at the rear of the instrument. A controller for remote control can be connected via the interface. The connection is effected using a shielded cable.

#### A.1.1 Characteristics of the Interface

- 8-bit parallel data transfer
- bidirectional data transfer
- three line handshake
- high data transfer rate of max. 350 kByte/s
- up to 15 devices can be connected
- maximal length of the connecting cables 15 m (single connection 2m)
- wired OR if several instruments are connected in parallel.

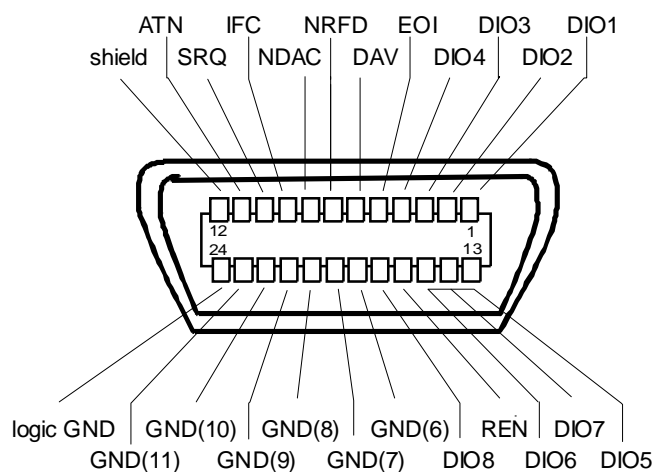

Fig. A-1 Contact Assignment of the IEC-bus socket

#### A.1.2 Bus Lines

##### 1. Data bus with 8 lines DIO 1 to DIO 8.

The transmission is bit-parallel and byte-serial in the ASCII/ISO code. DIO1 is the bit of lowest order, DIO8 the bit of highest order.

**2. Control bus with 5 lines.**

**IFC** (Interface Clear),  
active low resets the interfaces of the instruments connected to the default setting.

**ATN** (Attention),  
active low signals the transmission of interface messages  
inactive high signals the transmission of device-dependent messages.

**SRQ** (Service Request),  
active low enables a device connected to send a service request to the controller.

**REN** (Remote Enable),  
active low permits the switchover to remote control.

**EOI** (End or Identify),  
has two functions in connection with ATN:  
active low marks the end of data transmission with ATN=high  
active low triggers a parallel poll with ATN=low.

**3. Handshake bus with three lines.**

**DAV** (Data Valid),  
active low signals a valid data byte on the data bus.

**NRFD** (Not Ready For Data),  
active low signals that one of the device connected is not ready for data transfer.

**NDAC** (Not Data Accepted),  
active low as long as the instrument connected is accepting the data present on the data bus.

**A.1.3 Interface Functions**

Instruments which can be remote-controlled via IEC bus can be equipped with different interface functions. Table A-1 lists the interface functions appropriate for the instrument.

Table A-1 Interface function

Control character	Interface function
SH1	Handshake source function (source handshake)
AH1	Handshake drain function (acceptor handshake)
L4	Listener function.
T6	Talker function, ability to respond to serial poll
SR1	Service request function (Service Request)
PP1	Parallel poll function
RL1	Remote/Local switchover function
DC1	Resetting function (Device Clear)
DT1	Trigger function (Device Trigger)

### A.1.4 Interface Messages

Interface messages are transmitted to the instrument on the data lines, with the attention line being active (LOW). They serve to communicate between instrument and controller.

#### Universal Commands

The universal commands are encoded in the range 10 through 1F hex. They are effective for all instruments connected to the bus without addressing them before.

Table A-2 Universal Commands

Command	QuickBASIC command	Effect on the instrument
DCL (Device Clear)	IBCMD (controller%, CHR\$(20))	Aborts the processing of the commands just received and sets the command processing software to a defined initial state. Does not change the instrument setting.
IFC (Interface Clear)	IBSIC (controller%)	Resets the interfaces to the default setting.
LLO (Local Lockout)	IBCMD (controller%, CHR\$(17))	The LOC/IEC ADDR key is disabled.
SPE (Serial Poll Enable)	IBCMD (controller%, CHR\$(24))	Ready for serial poll
SPD (Serial Poll Disable)	IBCMD (controller%, CHR\$(25))	End of serial poll
PPU (Parallel Poll Unconfigure)	IBCMD (controller%, CHR\$(21))	End of the parallel-poll polling state

#### Addressed Commands

The addressed commands are encoded in the range 00 through 0F hex. They are only effective for instruments addressed as listeners.

Table A-3 Addressed Commands

Command	QuickBASIC command	Effect on the instrument
SDC (Selected Device Clear)	IBCLR (device%)	Aborts the processing of the commands just received and sets the command processing software to a defined initial state. Does not change the instrument setting.
GET (Group Execute Trigger)	IBTRG (device%)	Triggers a previously active device function (eg a sweep). The effect of the command is the same as with that of a pulse at the external trigger signal input.
GTL (Go to Local)	IBLOC (device%)	Transition to the "Local" state (manual control)
PPC (Parallel Poll Configure)	IBPPC (device%, data%)	Configure instrument for parallel poll. The QuickBASIC command additionally executes PPE / PPD.

## A.2 RS-232-C Interface

The instrument is fitted with an RS-232-C interface as standard. The 9-pin connector is at the rear panel. A controller can be connected via this interface for remote control.

### A.2.1 Interface characteristics

- Serial data transmission in asynchronous mode
- Bidirectional data transmission via two separate lines
- Transmission rate selectable from 1200 to 115200 baud
- Logic 0 signal from +3 V to +15 V
- Logic 1 signal from -15 V to -3 V
- An external instrument (controller) can be connected
- Software handshake (XON, XOFF)
- v Hardware handshake

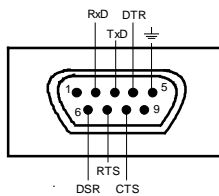

Fig. A-2 Pin assignment of RS-232-C connector

### A.2.2 Signal lines

**RxD** (Receive Data),  
Data line, transmission from external controller to instrument.

**TxD** (Transmit Data),  
Data line, transmission from instrument to external controller.

**DTR** (Data terminal ready),  
Output (log. 0 = active). With DTR, the instrument indicates that it is ready to receive data. The DTR line controls whether the instrument is ready for reception or not.

**GND**,  
Interface ground, connected to instrument ground.

**DSR** (Data set ready),  
(Instead of the CTS line, the DSR connector is used for instruments with a VAR2 REV3 front module.)

**RTS** (Request to send),  
Output (log 0 = active). With RTS, the instrument indicates that it is ready to receive data. The RTS line controls whether the instrument is ready for reception or not.

**CTS** (Clear to send),  
Input (log 0 = active). CTS tells the instrument that the opposite station is ready to receive data.

### A.2.2.1 Transmission parameters

To ensure an error-free and correct data transmission, the parameters of the instrument and the controller should have the same settings. The parameters are set in menu UTILITIES-SYSTEM-RS232.

**Transmission rate (baud rate)** The following baud rates can be set in the instrument: 1200, 2400, 4800, 9600, 19200, 38400, 57600, 115200.

**Data bits** Data transmission is in 8-bit ASCII code. The first bit transmitted is the LSB (Least Significant Bit).

**Start bit** Each data byte begins with a start bit. The falling edge of the start bit indicates the beginning of the data byte.

**Parity bit** A parity bit is not used.

**Stop bit** The transmission of a data byte is terminated by a stop bit.

**Example:**

Transmission of character A (41 hex) in the 8-bit ASCII code.

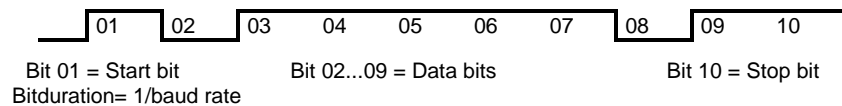

### A.2.3 Interface functions

For interface control, some control characters defined from 0 to 20 hex of the ASCII code can be transmitted via the interface (see Table A-4).

Table A-4 Interface functions (RS-232-C)

Control character	Interface function
<Ctrl Q> 11 hex	Enables character output (XON)
<Ctrl S> 13 hex	Inhibits character output (XOFF)
Break (at least 1 character only log 0)	Reset instrument
0Dhex, 0Ahex	Terminator <CR>, <LF> Switchover between local/remote



### A.2.3.1 Handshake

#### Software handshake

The software handshake with the XON/XOFF protocol controls data transmission. If the receiver wishes to inhibit data entry, it sends XOFF to the transmitter. The transmitter then interrupts the data output until it receives a XON. The same function is provided at the transmitter side (controller).

**Note:** Software handshake is not suitable for transmission of binary data. Use the hardware handshake.

#### Hardware handshake

In case of a hardware handshake the instrument signals that it is ready for reception via line DTR and RTS. A logic 0 means "ready" and a 1 means "not ready". Whether the controller is ready for reception or not is signalled to the instrument via lines CTS or DSR (see signal lines). The transmitter of the instrument is switched on by a 0 and off by a 1. Line RTS remains active as long as the serial interface is active. Line DTR controls whether the instrument is ready for reception or not.

#### Connection between instrument and controller

Connection of the instrument with the controller is via a so-called 0-modem cable. In this case, the data, control and signalling lines have to be cross-connected. For a controller with a 9-pin or 25-pin connector the following circuit diagram applies.

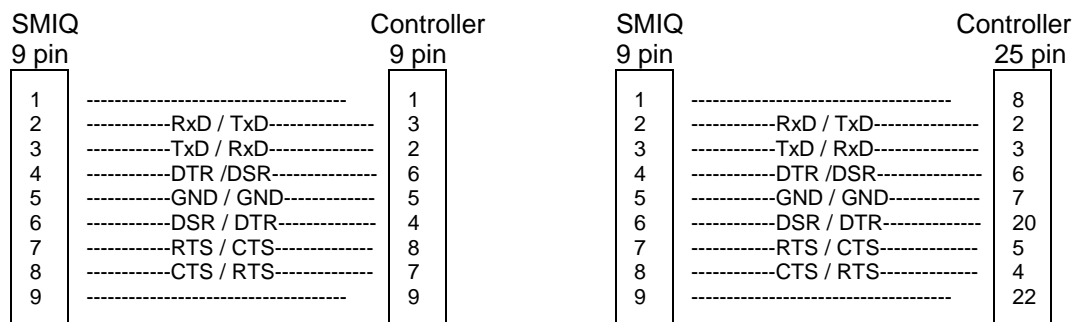

Fig. A-3 Wiring of data, control and signalling lines for hardware handshake

### A.3 Asynchronous Interface SERDATA

The SERDATA interface on the rear of SMIQ serves for the asynchronous serial transmission of modulation data. It is a RS-232-C interface with the following characteristics:

- Data transmission to SMIQ in one direction only via RxD line (Receive Data).
- Selectable data rate in menu UTILITIES-SYSTEM-SERDATA-BAUDRATE. The highest baud rate is 115 200.
- Hardware handshake only via RTS line (Request to send). With RTS, SMIQ is ready to receive data. After inactivating RTS, SMIQ can receive 32 bytes at max.
- Data transmission with start bit, 8 data bits (= 1 byte), stop bit. A parity bit is not used. The most significant bit of each modulation symbol has to be transmitted at first.

**Note:** *The baud rate has to be selected at least 25% higher than the bit rate of the digital modulation. If SMIQ has not enough data, the error message "Data underrun" will be issued in the status line.*

Connection between SERDATA and the external RS-232 data source is via a so-called null modem cable with crossed data and control lines.



## B Annex B

### B.1 List of Error Messages

The following list contains all error messages for errors occurring in the instrument. The meaning of negative error codes is defined in SCPI, positive error codes mark errors specific of the instrument.

The table contains the error code in the left-hand column. In the right-hand column the error text being entered into the error/event queue or being displayed is printed in bold face. Below the error text, there is an explanation as to the respective error.

#### B.1.1 SCPI-Specific Error Messages

No Error

Error code	Error text in the case of queue poll Error explanation
0	<b>No error</b> This message is output if the error queue does not contain entries.

Command Error - Faulty command; sets bit 5 in the ESR register

Error code	Error text in the case of queue poll Error explanation
-100	<b>Command Error</b> The command is faulty or invalid.
-101	<b>Invalid Character</b> The command contains an invalid sign.
-102	<b>Syntax error</b> The command is invalid.
-103	<b>Invalid separator</b> The command contains an impermissible separator.
-104	<b>Data type error</b> The command contains data of the wrong type (for example a string instead of a numeric value). Example: ON is indicated instead of a numeric value for frequency setting.
-105	<b>GET not allowed</b> A Group Execute Trigger (GET) is within a command line.
-109	<b>Missing parameter</b> The command contains too few parameters.

Continuation: Command Error

Error code	Error text in the case of queue poll Error explanation
-112	<b>Program mnemonic too long</b> The header contains more than 12 signs.
-113	<b>Undefined header</b> The header is not defined for the instrument. Example: *XYZ is undefined for every instrument.
-114	<b>Header suffix out of range</b> The header contains an impermissible numeric suffix. Example: SOURce3 does not exist in the instrument.
-123	<b>Exponent too large</b> The absolute value of the exponent is too large.
-124	<b>Too many digits</b> The number contains too many digits.
-128	<b>Numeric data not allowed</b> The command contains a number which is not allowed at this position.
-131	<b>Invalid suffix</b> The suffix is invalid for this instrument. Example: nHz is not defined.
-134	<b>Suffix too long</b> The suffix contains more than 12 signs.
-138	<b>Suffix not allowed</b> A suffix is not allowed for this command or at this position of the command.
-141	<b>Invalid character data</b> The text parameter either contains an invalid sign or it is invalid for this command Example: write error with parameter indication; SOURce:FREQuency:MODE FIXed.
-144	<b>Character data too long</b> The text parameter contains more than 12 signs.
-148	<b>Character data not allowed</b> The text parameter is not allowed for this command or at this position of the command.
-158	<b>String data not allowed</b> The command contains a valid character string at a position which is not allowed. Example: A text parameter is set in quotation marks, SOURce:FREQuency:MODE "FIXed".
-161	<b>Invalid block data</b> The command contains faulty block data. Example: An END message was received before the expected number of data had been received.
-168	<b>Block data not allowed</b> The command contains valid block data at an impermissible position.
-178	<b>Expression data not allowed</b> The command contains a mathematical expression at an impermissible position.

Execution Error - Error in executing the command; sets bit 4 in the ESR register

Error code	Error text in the case of queue poll Error explanation
-203	<p><b>Command protected</b> The desired command could not be executed as it was protected with a password. Use command <code>SYSTEM:PROTECT1 2 3 OFF, &lt;password&gt;</code> to enable the command. Example: The command <code>CALibrate:LPRreset?</code> is protected with a password.</p>
-211	<p><b>Trigger ignored</b> The trigger (GET, *TRG or trigger signal) was ignored due to device timing considerations.</p>
-221	<p><b>Settings conflict; ...</b> There is a setting conflict between the two parameters indicated after the semicolon. Example: The set FSK deviation is too large for the selected symbol rate. A value has to be corrected to obtain a valid output signal.</p>
-222	<p><b>Data out of range</b> The parameter value is out of the range permitted by the instrument. Example: Command *RCL only permits entries in the range of 0 to 50</p>
-223	<p><b>Too much data</b> The command contains too many data.</p>
-224	<p><b>Illegal parameter value</b> The parameter value is invalid.</p>
-225	<p><b>Out of memory</b> The storage space available in the instrument is exhausted. Example: An attempt is made to create more than 10 Memory Sequence lists.</p>
-226	<p><b>Lists not same length</b> The parts of a list have different lengths. This error message is also displayed if only part of a list has been transmitted via IEC bus. All parts of the list have to be transmitted always before it is executed. Example: The POWer list content is longer than the FREQuency list content, or only the POWer content is transmitted.</p>
-230	<p><b>Data corrupt or stale</b> The data are incomplete or invalid. Example: The instrument has aborted a measurement.</p>
-240	<p><b>Hardware error</b> The command cannot be executed due to problems with the instrument hardware.</p>
-241	<p><b>Hardware missing</b> The command cannot be executed due to missing hardware. Example: An option is not fitted.</p>
-255	<p><b>Directory full</b> The list management cannot accept any more lists as the maximum number of lists has already be attained. Example: Only 10 MEM SEQ lists can be created.</p>

Device Specific Error - sets bit 3 in the ESR register.

Error code	Error text in the case of queue poll Error explanation
-310	<b>System error</b> This error message suggests an error within the instrument. Please inform the R&S Service.
-311	<b>Memory error</b> Error in the instrument memory.
-313	<b>Calibration memory lost; ...</b> Loss of the calibration data indicated after the semicolon (usually by switching on with PRESET after the software update). The calibration data have to be restored by internal routines (see chapter 2, section Calibration) so that the instrument can operate properly.
-314	<b>Save/recall memory lost</b> Loss of the non-volatile data stored using *SAV? command.
-315	<b>Configuration memory lost</b> Loss of the non-volatile configuration data stored by the instrument.
-330	<b>Self-test failed; ...</b> An error was detected in the selftest named after the semicolon. An error-free operation of the module concerned is no longer guaranteed.  Example: "Selftest failed - CPU-RAM battery voltage below 2.5 V" indicates that the battery has to be replaced (see service manual).
-350	<b>Queue overflow</b> This error code is entered into the queue instead of the actual error code if the queue is full. It indicates that more errors have occurred than displayed.
-360	<b>Communication error</b> An error has occurred during the transmission or reception of data on the IEC/IEEE bus or via the RS-232 interface.

Query Error - Error in data request; sets bit 2 in the ESR register.

Error code	Error text in the case of queue poll Error explanation
-410	<b>Query INTERRUPTED</b> The query has been interrupted. Example: After a query, the instrument receives new data before the response has been sent completely.
-420	<b>Query UNTERMINATED</b> The query is missing or incomplete. No data in the output buffer.
-430	<b>Query DEADLOCKED</b> The query cannot be processed. Example: The input and output buffers are full, the instrument cannot continue operation.

## B.1.2 SMIQ-Specific Error Messages

Device-dependent Error - device-specific error; sets bit 3 in the ESR register.

Error code	Error text in the case of queue poll Error explanation
51	<b>IEC:No Listener</b> AMIQ cannot be driven, check IEC/IEEE-bus cable and address setting.
52	<b>IEC:No Talker</b> AMIQ requests data although it is not addressed as a talker.
53	<b>IEC:Timeout</b> The time limit for data transmission has been exceeded.
105	<b>Frequency underrange</b> The frequency is below the limit value guaranteed.
106	<b>Frequency overrange</b> The frequency is beyond the limit value guaranteed.
110	<b>Output unlevelled; ALC failure</b> Level control cannot attain the nominal value.
111	<b>IQCON: ALC loop failure</b> The local level control of the IQCON module cannot attain the nominal value.
117	<b>Dynamic level range exceeded</b> The difference between the maximal and minimal value of a level list is too large. An exact level setting is no longer guaranteed.
122	<b>User correction overrange or underrange</b> During user correction (UCOR) the permitted limits were exceeded.
127	<b>Signal output/DISTORTION settings mismatch – use RECALCULATE</b> Settings for DISTORTION were modified during operation, they should be recalculated with RECALCULATE.
130	<b>FM modulator VCO unlocked</b> FM modulator VCO is not synchronized.
131	<b>AM modulation frequency out of range</b> The AM modulation frequency is out of the permissible range.
132	<b>PM modulation frequency out of range</b> The PM modulation frequency is out of the permissible range.
135	<b>AM bandwidth reduced at RF below 5 MHz</b> The bandwidth of AM is reduced below 5 MHz, see data sheet.
140	<b>This modulation forces other modulations OFF</b> A modulation has been switched on which cannot be used at the same time as an already active modulation. The previous modulation has been switched off.
141	<b>Controlling of input voltage at EXT1 not possible</b> The voltage monitoring at EXT1 input does not work with multi-tone or mixer modulation. Example: AM SOURCE INT and AM SOURCE EXT are simultaneously activated.
152	<b>Input voltage out of range; EXT1 too high</b> The input voltage at the EXT1 socket is too high.
153	<b>Input voltage out of range; EXT1 too low</b> The input voltage at the EXT1 socket is too low.



Continuation: Device-dependent Error

Error code	Error text in the case of queue poll Error explanation
154	<b>Input voltage out of range; EXT2 too high</b> The input voltage at the EXT2 socket is too high.
155	<b>Input voltage out of range; EXT2 too low</b> The input voltage at the EXT2 socket is too low.
161	<b>Output protection tripped</b> The overvoltage protection has responded (cf. Section 2.5.8).
171	<b>Oven cold</b> The reference oscillator has not yet reached its operating temperature.
172	<b>Reference frequency 100 MHz VCXO unlocked</b> The 100 MHz crystal oscillator of the reference frequency is not synchronized. This error message often occurs with error 171 since the frequency errors of the reference oscillator exceed the pull-in range of the 100 MHz oscillator during warmup.
173	<b>Step synthesis unlocked</b> The step synthesis has not been synchronized.
180	<b>Calibration failed; ...</b> The calibration named after the semicolon was not successfully performed.
181	<b>REF OSC calibration data not used because ADJUSTMENT STATE is ON</b> The reference-oscillator calibration data are not used as long as ADJUSTMENT STATE is activated.
182	<b>Calibration data missing</b> Calibration data are missing in the device memory. The calibration data have to be generated first by an internal or external calibration or to be loaded into the device (see section Calibration).
183	<b>Learning failed; ALC OFF MODE = TABLE</b> An error occurred on applying the internal ALC OFF table. If this error again occurs after a new internal calibration (see chapter Calibration, CALIB ALL) there is a hardware failure. Please contact your local Rohde & Schwarz representative.
184	<b>MCOD calibration not correctly</b> The internal offset calibration of the modulation coder is faulty which generates a larger carrier leakage with digital modulation. If this error occurs repeatedly after recalibration of vector modulation, there is a hardware failure. Please contact your local Rohde & Schwarz representative.
200	<b>Cannot access hardware</b> The data transmission to a module was unsuccessful.
201	<b>Function not supported by this hardware revision</b> A later version of certain parts of the instrument is necessary to execute the function selected.
202	<b>Diagnostic A/D converter failure</b> The diagnosis analog/digital converter has failed. <b>This generates error 211 since this D/A converter is also used for frequency setting.</b>
203	<b>DGEN;...</b> The error named after the semicolon has occurred in the data generator. If this error occurs even after PRESET with standard settings, there is a hardware failure. Please contact your local Rohde & Schwarz representative.
204	<b>MCOD event ...</b> An error has occurred in the modulation coder during calculation. If this error occurs even after PRESET with standard settings, there is a hardware failure. Please contact your local Rohde & Schwarz representative.

Continuation: Device-dependent Error

Error code	Error text in the case of queue poll Error explanation
211	<b>Summing loop unlocked</b> The PLL of the summing loop has not been synchronized.
221	<b>Digital synthesis buffer VCO unlocked</b> The VCO of the buffer loop has not been synchronized.
224	<b>2.4 GHz LO loop unlocked</b> The 2.4 GHz local oscillator of the IQMOD module has not been synchronized.
225	<b>MCOD: PLL unlocked</b> The clock generator PLL of the modulation coder is not synchronized. Example: SOURCE EXT_SER has been selected with digital modulation but no signal is applied.
240	<b>Invalid list; odd number of elements</b> The list selected contains an odd number of elements. Some lists, however, must contain an even number of elements.
241	<b>No list defined</b> There is no list defined.
242	<b>List not learned; execute LEARN command</b> The instrument has been switched to LIST mode and a list has been selected. However, command LEARN has not been executed.
243	<b>Dwell time adjusted</b> A dwell time given on a list cannot be processed by the unit. The setting was automatically adjusted.
244	<b>List is active; Cannot change, edit or delete list</b> A list used for modulation cannot be changed, modified or deleted at the same time. The modulation has to be switched off beforehand.  <b>List is protected; Cannot edit or delete list</b> Protected lists cannot be modified or deleted.
245	<b>List system check failed; Reset of list system on DGEN</b> On power-up, errors were detected in the lists of the data generator and a reset of the list system was performed. The stored lists are deleted. A possible cause is a flat battery (UTILITIES/TEST/DGEN RAM BATTERY).
246	<b>List name is reserved; Use a different name</b> The user tried to generate a list with an internally reserved name, another one has to be selected.
247	<b>List is empty</b> The user tried to use an empty list. Data have to be entered.
251	<b>No User Correction Table; zero assumed</b> An attempt has been made to switch on user correction, but no UCOR table has been stored in the instrument yet. The instrument behaves as if a table was called which only contains 0-values.

Continuation: Device-dependent Error

Error code	Error text in the case of queue poll Error explanation
257	<b>Hop list index exceeds list range</b> The index of a hop list exceeds its defined range. The index should not be used or the list should be extended.
260	<b>Invalid keyboard input ignored</b> An invalid input via the keyboard is not considered.
265	<b>This parameter is read only</b> An attempt has been made to change a fixedly specified value.
270	<b>Data output aborted</b> Data output was aborted on the IEC/IEEE-bus. Example: The key [LOCAL] was pressed.
280	<b>Use ALC OFF MODE = TABLE for uninterrupted level setting</b> With ALC OFF MODE S&H interruptions occur on setting the level due to sampling. To avoid this select ALC OFF MODE = TABLE.
281	<b>Use &lt;MOD ON/OFF&gt; key or switch on to recalculate</b> On modifying parameters some digital modulation types are switched off to allow entry of several parameters without superfluous time-consuming intermediate calculations. After entry of all parameters, the modulation should be switched on again. To do this press the <MOD ON/OFF> key or select STATE ON.
304	<b>String too long</b> A character string which is too long was received via the IEC bus. Example: The names of lists have a limited length (see corresponding section).
305	<b>Fill pattern too long; truncated</b> More data have been entered with block function FILL in the list editor than the filling range (RANGE) set permits. The exceeding data are ignored.
306	<b>No fill pattern specified</b> An attempt was made to execute a filler function without having to indicate a filler pattern.
400	<b>DGEN: no data</b> The DSP of the data generator receives no data from the FIFO due to overload. Remedy: first select STATE OFF, check if the symbol rate and the trigger frequency is not too high with external triggering, do not perform any other settings when STATE ON is selected again.
401	<b>DGEN: no switch</b> The DSP of the data generator receives no signals from the check list due to overload. Remedy: as for 400.
402	<b>DGEN: no guard time between slots</b> The burstgate edges of two slots are adjacent or overlap, ramping cannot be properly performed. The edges have to be reset.
403	<b>DGEN: no frame counter end</b> Internal error message. If this error occurs even after PRESET and switching on and off, there is a hardware failure. Please contact your local Rohde & Schwarz representative.
404	<b>DGEN: SERDATA: not enough data</b> Not enough data have been delivered to SER DATA input for the set symbol rate. The data should be fed faster or the symbol rate reduced.
410	<b>FADING SIM: all path states set to OFF; no output level</b> <b>IS95/WCDMA: all channel states set to OFF; no output level</b> All paths are switched off so that no output level can be generated.

Continuation: Device-dependent Error

Error code	Error text in the case of queue poll Error explanation
411	<p><b>MCOD: modulation bandwidth exceeds IQ or Nyquist bandwidth</b> The modulation bandwidth exceeds the IQ or Nyquist bandwidth, the modulation accuracy is reduced. A narrowband filtering or a lower symbol rate should be selected.</p>
420	<p><b>AWGN/NDSIM FPGA data loading failed</b> The FPGA data of AWGN/NDSIM module could not be loaded. If this error occurs again after switching on and off, there is a hardware failure. Please contact your local Rohde &amp; Schwarz representative.</p>
421	<p><b>AWGN/NDSIM distortion error</b> An error has occurred in the distortion simulator. If this error occurs even after PRESET with standard settings, there is a hardware failure. Please contact your local Rohde &amp; Schwarz representative.</p>
422	<p><b>AWGN/NDSIM noise error</b> An error has occurred in the noise generator. If this error occurs even after PRESET with standard settings, there is a hardware failure. Please contact your local Rohde &amp; Schwarz representative.</p>
423	<p><b>AWGN/NDSIM data calculation error; ...</b> Volatile error message which explains in detail how errors 420 to 422 occur.</p>
424	<p><b>AWGN/NDSIM data download error</b> An error has occurred during data transmission to AWGN/NDSIM. If this error occurs again after switching on and off, there is a hardware failure. Please contact your local Rohde &amp; Schwarz representative.</p>
425	<p><b>AWGN/NDSIM list error; ...</b> The error named after the semicolon has occurred in one of the used lists, eg when several different x and y values are entered. The list should be accordingly corrected.</p>
426	<p><b>Absolute value of level correction &gt; crest factor of digital modulation</b> The LEVEL CORRECTION value available is faulty and generates an rms value which is higher than the peak value.</p>
440	<p><b>AMIQ error; cannot detect AMIQ</b> The call setup to AMIQ is not possible. Example: The IEC/IEEE-bus cable is not connected or defective, an IEC/IEEE-bus address is assigned twice.</p> <p><b>AMIQ error, ...</b></p> <p><b>Error message of a connected AMIQ, see operating manual AMIQ</b></p>



## C Annex C

### C.1 List of Commands (with SCPI Conformity Information)

The SMIQ supports SCPI version 1994.0. For remote control, commands which were specified or accepted in this SCPI version have been used to a large extent. Commands which are not part of the SCPI specification are marked "not-SCPI" in the SCPI info.

Command	Parameter	SCPI Info	Page
:ABORt[:SWEep]		not-SCPI	3.17
:ABORt:LIST		not-SCPI	3.17
:ABORt:MSEquence		not-SCPI	3.17
:ARB:STATe	ON   OFF	not-SCPI	3.18
:ARB:SEQuence	AUTO   RETRigger   AAUTO   ARETrigger	not-SCPI	3.19
:ARB:WAVEform:SElect	'<name>'	not-SCPI	3.19
:ARB:WAVEform:DElete	'<name>'	not-SCPI	3.19
:ARB:WAVEform:DATA	'name', <binary block data>	not-SCPI	3.19
:ARB:WAVEform:CATalog?		not-SCPI	3.19
:ARB:WAVEform:CATalog:LENGth?		not-SCPI	3.19
:ARB:WAVEform:TAG? '<tagname>'		not-SCPI	3.19
:ARB:WAVEform:FREE?		not-SCPI	3.20
:ARB:WAVEform:POINts?		not-SCPI	3.20
:ARB:TRIGger:SOURce	INTernal   EXTernal	not-SCPI	3.20
:ARB:TRIGger:DElay	0 to 65 535	not-SCPI	3.20
:ARB:TRIGger:INHibit	0 to 67.1E6	not-SCPI	3.20
:ARB:TRIGger:OUTPut[1]2:POLarity	POSitive   NEGative	not-SCPI	3.20
:ARB:TRIGger:OUTPut[1]2:DElay	0 to 524 255	not-SCPI	3.20
:ARB:TRIGger:OUTPut[1]2:MODE	USER   'mode_string'	not-SCPI	3.20
:ARB:TRIGger:OUTPut[1]2:MODE:CALalog?		not-SCPI	3.20
:ARB:TRIGger:OUTPut[1]2:ONTime	0 to 524 255	not-SCPI	3.21
:ARB:TRIGger:OUTPut[1]2:OFFTime	0 to 524 255	not-SCPI	3.21
:ARB:ASET:STATe	ON   OFF	not-SCPI	3.21
:ARB:ASET:DM:IQFilter	ON   OFF	not-SCPI	3.21
:ARB:ASET:DM:IQSWap	ON   OFF	not-SCPI	3.21
:ARB:ASET:BERT:TYPE	ON   OFF	not-SCPI	3.21
:ARB:ASET:TRIGger:MODE	ON   OFF	not-SCPI	3.21
:ARB:CLOCK	1kHz to 40.0 MHz	not-SCPI	3.21
:ARB:CLOCK:SOURce	INTernal   EXTernal	not-SCPI	3.22
:ARB:CLOCK:DElay	0.0 to 0.99	not-SCPI	3.22
:ARB:IQ:LEVel	-3 dB to +6 dB	not-SCPI	3.22
:ARB:IQ:LEVel:MODE	MANuell   AUTO	not-SCPI	3.22
:ARB:IQ:SKEW	-1000 to 1000 ps	not-SCPI	3.22
:BERT:STATe	ON   OFF	not-SCPI	3.30
:BERT:SEQuence	AUTO   SINGLE	not-SCPI	3.30
:BERT:SETup:MCOunt	1 to 4294967294	not-SCPI	3.31
:BERT:SETup:MERRor	1 to 4294967294	not-SCPI	3.31

Command	Parameter	SCPI Info	Page
:BERT:SETup:TYPE	PRBS9   PRBS11   PRBS15   PRBS16   PRBS20   PRBS21   PRBS23	not-SCPI	3.31
:BERT:SETup:DATA[:POLarity]	NORM   INVerted	not-SCPI	3.31
:BERT:SETup:CLOCK[:POLarity]	RISing   FALLing	not-SCPI	3.31
:BERT:SETup:REStart	INTernal   EXTernal	not-SCPI	3.31
:BERT:SETup:DENAble	OFF   LOW   HIGH	not-SCPI	3.32
:BERT:SETup:MASK	OFF   LOW   HIGH	not-SCPI	3.32
:BERT:SETup:IGNore	OFF   ONE   ZERO	not-SCPI	3.32
:BERT:SETup:UNIT	OFF   PCT   PPM	not-SCPI	3.32
:BERT:START		not-SCPI	3.32
:BERT:STOP		not-SCPI	3.32
:BERT:RESult?		not-SCPI	3.33
:BLER:STATe	ON   OFF	not-SCPI	3.34
:BLER:SEQuence	AUTO   SINGLE	not-SCPI	3.34
:BLER:SETup:MCOunt	1 to 4294967294	not-SCPI	3.34
:BLER:SETup:MERRor	1 to 4294967294	not-SCPI	3.35
:BLER:SETup:TYPE?		not-SCPI	3.35
:BLER:SETup:DATA[:POLarity]	NORMal   INVerted	not-SCPI	3.35
:BLER:SETup:CLOCK[:POLarity]	RISing   FALLing	not-SCPI	3.35
:BLER:SETup:DENAble	LOW   HIGH	not-SCPI	3.35
:BLER:SETup:UNIT	SCientific   ENGineering   PCT   PPM	not-SCPI	3.35
:BLER:START		not-SCPI	3.35
:BLER:STOP		not-SCPI	3.35
:BLER:RESult?		not-SCPI	3.36
:CALibration[:ALL]			3.37
:CALibration:FSIM[:MEASure]?		not-SCPI	3.37
:CALibration:LATTenuation[:MEASure]?		not-SCPI	3.37
:CALibration:LEVel:DATA?		not-SCPI	3.38
:CALibration:LEVel:STATe	ON   OFF	not-SCPI	3.38
:CALibration:LPReset[:MEASure]?		not-SCPI	3.38
:CALibration:LPReset:DATA?		not-SCPI	3.38
:CALibration:NDSim[:MEASure]?		not-SCPI	3.38
:CALibration:ROSCillator[:DATA]	0 to 4095	not-SCPI	3.38
:CALibration:VSUMmation[:MEASure]?		not-SCPI	3.39
:CALibration:VSUMmation:OFFS?		not-SCPI	3.39
:CALibration:VSUMmation:DAC?		not-SCPI	3.39
:CALibration:VSUMmation:KOS?		not-SCPI	3.39
:CALibration:VMODulation[:MEASure]?		not-SCPI	3.39
:CALibration:LFGenerator[:MEASure]?		not-SCPI	3.39
:DIAGnostic:CLISt:CHECksum:CALCulate			3.40
:DIAGnostic:CLISt:CHECksum:DATA?			3.40
:DIAGnostic:CNMeasure:MODE	CN   CARRier   NOISe		3.40
:DIAGnostic:DLISt:CHECksum:CALCulate			3.41
:DIAGnostic:DLISt:CHECksum:DATA?			3.41
:DIAGnostic:INFO:CCOunt:ATTenuator1 2 3 4 5 6?			3.41
:DIAGnostic:INFO:CCOunt:POWer?			3.41

Command	Parameter	SCPI Info	Page
:DIAGnostic:INFO:MODules?			3.41
:DIAGnostic:INFO:OTIMe?			3.42
:DIAGnostic:INFO:SDATe?			3.42
:DIAGnostic[:MEASure]:POINt?			3.42
:DISPlay:ANNotation[:ALL]	ON   OFF		3.43
:DISPlay:ANNotation:AMPLitude	ON   OFF		3.43
:DISPlay:ANNotation:FREQuency	ON   OFF		3.43
:FORMat[:DATA]	ASCIi   PACKed		3.44
:FORMat:BORDer	NORMal   SWAPped		3.44
:MEMory:NSTATes?			3.45
:OUTPut:AMODE	AUTO   FIXed   ELEctronic	not-SCPI	3.46
:OUTPut:AFIXed RANGe UPPer?		not-SCPI	3.46
:OUTPut:AFIXed RANGe LOWer?		not-SCPI	3.46
:OUTPut:BLANk[:POLarity]	NORMal   INVerted	not-SCPI	3.47
:OUTPut:IMPedance?			3.47
:OUTPut:PROTEction:CLEar			3.47
:OUTPut:PROTEction:TRIPped?			3.47
:OUTPut[:STATe]	ON   OFF		3.47
:OUTPut[:STATe]:PON	OFF   UNCHanged	not-SCPI	3.47
:OUTPut2[:STATe]	ON   OFF		3.48
:OUTPut2:VOLTage	0 V to 4 V	not-SCPI	3.48
[:SOURce]:AM:BBANd[:STATe]	ON   OFF		3.50
[:SOURce]:AM[:DEPTh]	0 to 100 PCT		3.50
[:SOURce]:AM:EXTernal:COUpling	AC   DC		3.50
[:SOURce]:AM:INTernal:FREQuency	0.1 Hz to 1 MHz		3.50
[:SOURce]:AM:SOURce	EXT   INT   EXT, INT		3.50
[:SOURce]:AM:STATe	ON   OFF		3.50
[:SOURce]:CORRection[:STATe]	ON   OFF		3.51
[:SOURce]:CORRection:CSET:CATalog?		not-SCPI	3.51
[:SOURce]:CORRection:CSET[:SELEct]	'Tabellenname'		3.51
[:SOURce]:CORRection:CSET:DATA:FREQuency	300 kHz to RF <sub>max</sub> {,300 kHz to RF <sub>max</sub> }	not-SCPI	3.51
[:SOURce]:CORRection:CSET:DATA:POWER	-40dB to 6dB {,-40dB to 6dB}	not-SCPI	3.52
[:SOURce]:CORRection:CSET:DELeTe	'Tabellenname'	not-SCPI	3.52
[:SOURce]:DECT:STATe	ON   OFF	not-SCPI	3.54
[:SOURce]:DECT:STANdard		not-SCPI	3.54
[:SOURce]:DECT:FORMat	GFSK   P4DQpsk	not-SCPI	3.55
[:SOURce]:DECT:FSK:DEViation	1kHz to 1,2 MHz	not-SCPI	3.55
[:SOURce]:DECT:SRATe	1kHz to 1.2 MHz	not-SCPI	3.55
[:SOURce]:DECT:FILTer:TYPE	GAUSSs   SCOSine   COSine   USER	not-SCPI	3.55
[:SOURce]:DECT:FILTer:SELEct	'name'	not-SCPI	3.55
[:SOURce]:DECT:FILTer:PARAmeter	0.2 to 0.7	not-SCPI	3.55
[:SOURce]:DECT:SEQUence	AUTO   RETRigger   AAUTO   ARETrigger	not-SCPI	3.55
[:SOURce]:DECT:TRIGger:SOURce	EXTernal   INTernal	not-SCPI	3.55
[:SOURce]:DECT:TRIGger:INHibit	0 to 67.1E6	not-SCPI	3.56
[:SOURce]:DECT:TRIGger:DELay	0 to 65535	not-SCPI	3.56
[:SOURce]:DECT:TRIGger:OUTPut[1][2]:DELay	0 to 11519	not-SCPI	3.56



Command	Parameter	SCPI Info	Page
[:SOURce]:DECT:TRIGger:OUTPut[2]:PERiod	1 to 67.1E6	not-SCPI	3.56
[:SOURce]:DECT:CLOCK:SOURce	INTernal   EXTernal		3.56
[:SOURce]:DECT:CLOCK:DELay	0 to 1.0	not-SCPI	3.56
[:SOURce]:DECT:PRAMp:PRESet		not-SCPI	3.56
[:SOURce]:DECT:PRAMp:TIME	0.25 to 16.0	not-SCPI	3.56
[:SOURce]:DECT:PRAMp:SHApe	LINear   COSine	not-SCPI	3.57
[:SOURce]:DECT:PRAMp:ROFFset	-9 to +9	not-SCPI	3.57
[:SOURce]:DECT:PRAMp:FOFFset	-9 to +9	not-SCPI	3.57
[:SOURce]:DECT:SLOT:ATTenuation	0 to 70 dB	not-SCPI	3.57
[:SOURce]:DECT:SIMulation:TADJustment	-4 to +4 (in Symbolen)	not-SCPI	3.57
[:SOURce]:DECT:SIMulation:JITTer	0 to 4 (in Symbolen)	not-SCPI	3.57
[:SOURce]:DECT:FLISt:PREDefined:CATalog?		not-SCPI	3.57
[:SOURce]:DECT:FLISt:PREDefined:LOAD	'Framelisten-Name'	not-SCPI	3.57
[:SOURce]:DECT:FLISt:CATalog?		not-SCPI	3.58
[:SOURce]:DECT:FLISt:LOAD	'name'	not-SCPI	3.58
[:SOURce]:DECT:FLISt:STORE	'Framelisten-Name'	not-SCPI	3.58
[:SOURce]:DECT:FLISt:DELeTe	'name'	not-SCPI	3.58
[:SOURce]:DECT:DLISt:CATalog?		not-SCPI	3.58
[:SOURce]:DECT:PREamble:TYPE	NORMal   PROLonged	not-SCPI	3.58
[:SOURce]:DECT:SLOT<i>:TYPE	FULL   DOUBle   ADATA	not-SCPI	3.58
[:SOURce]:DECT:SLOT<i>:LEVel	OFF   ATT   FULL	not-SCPI	3.58
[:SOURce]:DECT:SLOT<i>:PRESet		not-SCPI	3.59
[:SOURce]:DECT:SLOT<i>:STSHift	-9 to +9 (in Bit)	not-SCPI	3.59
[:SOURce]:DECT:SLOT<i>:RAMP:CW	ON   OFF	not-SCPI	3.59
[:SOURce]:DECT:SLOT<i>:RAMP:DATA	0 to 111 to (12 bit)	not-SCPI	3.59
[:SOURce]:DECT:SLOT<i>:PREamble:DATA	0 to 111 to (16 bit)	not-SCPI	3.59
[:SOURce]:DECT:SLOT<i>:PREamble:PROLonged:DATA	0 to 111 to (32 bit)	not-SCPI	3.59
[:SOURce]:DECT:SLOT<i>:SYNC	#B0 to #B111 to (16Bit)	not-SCPI	3.59
[:SOURce]:DECT:SLOT<i>[:SOURce]:AFIeld	PN9   PN11   PN15   PN16   PN20   PN21   PN23   DLISt   SDATa	not-SCPI	3.59
[:SOURce]:DECT:SLOT<i>[:SOURce]:AFIeld:DLISt	'name'	not-SCPI	3.59
[:SOURce]:DECT:SLOT<i>[:SOURce]:BFIeld	PN9   PN11   PN15   PN16   PN20   PN21   PN23   DLISt   SDATa	not-SCPI	3.60
[:SOURce]:DECT:SLOT<i>[:SOURce]:BFIeld:DLISt	'name'	not-SCPI	3.60
[:SOURce]:DECT:SLOT<i>[:SOURce]:ZFIeld	ON   OFF	not-SCPI	3.60
[:SOURce]:DISTortion[:STATe]	ON   OFF	not-SCPI	3.61
[:SOURce]:DISTortion:MODE	POLYnomial   DATA	not-SCPI	3.61
[:SOURce]:DISTortion:DATA:CATalog?		not-SCPI	3.62
[:SOURce]:DISTortion:DATA:SELeCt	'Name der Kennlinie'	not-SCPI	3.62
[:SOURce]:DISTortion:DATA:DELeTe	'Name der Kennlinie'	not-SCPI	3.62
[:SOURce]:DISTortion:DATA:DELeTe:ALL		not-SCPI	3.62
[:SOURce]:DISTortion:DATA:AM	'-100 dB to 0 dB {, -100 dB to 0 dB}   Blockdaten'	not-SCPI	3.62
[:SOURce]:DISTortion:DATA:AM:FREE?		not-SCPI	3.62
[:SOURce]:DISTortion:DATA:AM:POINTs?		not-SCPI	3.62
[:SOURce]:DISTortion:DATA:AMBase	'-100 dB to 0 dB {, -100 dB to 0 dB}   Blockdaten'	not-SCPI	3.62

Command	Parameter	SCPI Info	Page
[[:SOURce]:]DISTortion:DATA:AMBase:POINTs?		not-SCPI	3.63
[[:SOURce]:]DISTortion:DATA:PM	'-180 Grad to +180 Grad {, -180 Grad to +180 Grad}   Blockdaten'	not-SCPI	3.63
[[:SOURce]:]DISTortion:DATA:PM:FREE?		not-SCPI	3.63
[[:SOURce]:]DISTortion:DATA:PM:POINTs?		not-SCPI	3.63
[[:SOURce]:]DISTortion:DATA:PMBase	'-100 dB to 0 dB {, -100 dB to 0 dB}   block data	not-SCPI	3.63
[[:SOURce]:]DISTortion:DATA:PMBase:POINTs?		not-SCPI	3.63
[[:SOURce]:]DISTortion:DATA:LEVel:CORRection	-20.0 to 6.00 dB	not-SCPI	3.63
[[:SOURce]:]DISTortion:POLYnomial:AMAM:K<i>	-10 dB to +10 dB	not-SCPI	3.63
[[:SOURce]:]DISTortion:POLYnomial:AMPM:K<i>	-60 deg to +60 deg	not-SCPI	3.64
[[:SOURce]:]DISTortion:POLYnomial:IFUNction	ON   OFF	not-SCPI	3.64
[[:SOURce]:]DISTortion:POLYnomial:LEVel:CORRection	-20 dB to +6 dB	not-SCPI	3.64
[[:SOURce]:]DISTortion:RECalculate		not-SCPI	3.64
[[:SOURce]:]DM:IQ:STATe	ON   OFF	not-SCPI	3.65
[[:SOURce]:]DM:IQ:CREStfactor	0 to 30 dB	not-SCPI	3.65
[[:SOURce]:]DM:IQ:PRAMp	OFF   AEXternal	not-SCPI	3.65
[[:SOURce]:]DM:IQ:IMPairment[::STATe]	ON   OFF	not-SCPI	3.65
[[:SOURce]:]DM:IQ:FILTer:STATe	ON   OFF		3.66
[[:SOURce]:]DM:IQ:FILTer:FREQuency	850 kHz, 2,5 MHz, 5 MHz		3.66
[[:SOURce]:]DM:IQ:TRANsition	ON   OFF		3.66
[[:SOURce]:]DM:LEAKage[::MAGNitude]	0 to 50.0 PCT		3.66
[[:SOURce]:]DM:QUADrature:ANGLe	10.0 to 10.0 DEG		3.66
[[:SOURce]:]DM:IQRatio[::MAGNitude]	-12.0 to 12.0 PCT		3.66
[[:SOURce]:]DM:IQSWap[::STATe]	ON   OFF	not-SCPI	3.66
[[:SOURce]:]DM:STATe	ON   OFF		3.69
[[:SOURce]:]DM:SEQUence	AUTO   RETRigger   AAUto   ARETrigger   SINGLE	not-SCPI	3.69
[[:SOURce]:]DM:SOURce	PRBS   PATtern   DLISt   SERial   PARAllel   SDATa		3.69
[[:SOURce]:]DM:PATtern	ZERO   ONE   ALTErnate	not-SCPI	3.69
[[:SOURce]:]DM:PRBS[::LENGth]	9   15   16   20   21   23	not-SCPI	3.69
[[:SOURce]:]DM:DLISt:DATA	0   1 {,0   1 }..	not-SCPI	3.69
[[:SOURce]:]DM:DLISt:DATA?	[<Start> [,<Länge>]]	not-SCPI	3.70
[[:SOURce]:]DM:DLISt:DATA:APPend	0   1 {,0   1 }..	not-SCPI	3.70
[[:SOURce]:]DM:DLISt:CATalog?		not-SCPI	3.70
[[:SOURce]:]DM:DLISt:SELect	'<Datenlisten-Name>'	not-SCPI	3.70
[[:SOURce]:]DM:DLISt:DELeTe	'<Datenlisten-Name>'	not-SCPI	3.70
[[:SOURce]:]DM:DLISt:COpy	'<Datenlisten-Name>'	not-SCPI	3.70
[[:SOURce]:]DM:DLISt:FREE?		not-SCPI	3.70
[[:SOURce]:]DM:DLISt:POINTs	<n>	not-SCPI	3.70
[[:SOURce]:]DM:CLISt:CONTRol[::STATe]	ON   OFF	not-SCPI	3.71
[[:SOURce]:]DM:CLISt:DATA	<struc>{,<struc>} to	not-SCPI	3.71
[[:SOURce]:]DM:CLISt:CATalog?		not-SCPI	3.71
[[:SOURce]:]DM:CLISt:SELect	'<name>'	not-SCPI	3.71
[[:SOURce]:]DM:CLISt:DELeTe	'<name>'	not-SCPI	3.71
[[:SOURce]:]DM:CLISt:COpy	'<name>'	not-SCPI	3.72

Command	Parameter	SCPI Info	Page
[SOURce]:DM:CLISt:FREE?		not-SCPI	3.72
[SOURce]:DM:CLISt:POINts?		not-SCPI	3.72
[SOURce]:DM:MLISt:DATA	A,B,C,D,E,F,I1,Q1,I2,Q2..	not-SCPI	3.72
[SOURce]:DM:MLISt:CATalog?		not-SCPI	3.73
[SOURce]:DM:MLISt:SElect	<name>	not-SCPI	3.73
[SOURce]:DM:MLISt:DElete	<name>	not-SCPI	3.73
[SOURce]:DM:MLISt:FREE?		not-SCPI	3.73
[SOURce]:DM:MLISt:POINts?		not-SCPI	3.73
[SOURce]:DM:FLISt:DATA	A,B,C,D,I1,Q1,I2,Q2..	not-SCPI	3.73
[SOURce]:DM:FLISt:CATalog?		not-SCPI	3.73
[SOURce]:DM:FLISt:SElect	<name>	not-SCPI	3.73
[SOURce]:DM:FLISt:DElete	<name>	not-SCPI	3.74
[SOURce]:DM:FLISt:FREE?		not-SCPI	3.74
[SOURce]:DM:FLISt:POINts?		not-SCPI	3.74
[SOURce]:DM:STANDard	APCFm   APCQpsk   ASK   BLUetooth   CDPD   CT2   DECT   GSM   GSMEdge   IRIDIum   FIS95   RIS95   NADC   PDC   PHS   TETRa   TFTS   PWT   ICOBpsk   ICOGmsk   ICOQpsk   WORLdspace   QWCDma   AT55	not-SCPI	3.74
[SOURce]:DM:FORMat	BPSK   QPSK   QIS95   QINmarsat   QICO   QWCDma   OQPSk   OIS95   P4QPsk   P4DQpsk   PSK8   PSKE8   GFSK   GMSK   ASK   FSK2   FSK4   AFSK4   QAM16   QAM32   QAM 64   QAM256   USER		3.74
[SOURce]:DM:MDElay?		not-SCPI	3.74
[SOURce]:DM:ASK:DEPTh	0 to 100 PCT	not-SCPI	3.74
[SOURce]:DM:FSK:DEViatioN	100Hz to 2.5 MHz	not-SCPI	3.75
[SOURce]:DM:SRATe	1kHz to 7 MHz	not-SCPI	3.75
[SOURce]:DM:FILTer:TYPE	SCOSine   COSine   GAUSs   BESS1   BESS2   IS95   EIS95   APCO   TETRa   WCDMa   SPHase   USER	not-SCPI	3.75
[SOURce]:DM:FILTer:PARAmeter	0.1 to 1.0	not-SCPI	3.75
[SOURce]:DM:FILTer:MODE	LACP   LEVM	not-SCPI	3.75
[SOURce]:DM:CODing	OFF   DIFF   DPHS   DGRay   GSM   NADC   PDC   PHS   TETRa   TFTS   INmarsat   APCO25   VDL	not-SCPI	3.75
[SOURce]:DM:CLOCK:SOURce	INTernal   EXTernal   COUpled		3.75
[SOURce]:DM:CLOCK:MODE	BIT   SYMBol	not-SCPI	3.76
[SOURce]:DM:CLOCK:DElay	0 to 1.0	not-SCPI	3.76
[SOURce]:DM:CLOCK:POLarity	NORMal   INVerted	not-SCPI	3.76
[SOURce]:DM:LDIStortion[:STATe]	ON   OFF	not-SCPI	3.76
[SOURce]:DM:PRAMP[:STATe]	ON   OFF	not-SCPI	3.76
[SOURce]:DM:PRAMP:SOURce	CLISt   AEXTernal   DEXTernal	not-SCPI	3.76
[SOURce]:DM:PRAMP:TIME	0.25 to 32	not-SCPI	3.76
[SOURce]:DM:PRAMP:DElay	-1.0 to +5.0	not-SCPI	3.76
[SOURce]:DM:PRAMP:SHAPE	LINear   COSine	not-SCPI	3.77
[SOURce]:DM:PRAMP:ATTenuation	0 to 70.0 dB	not-SCPI	3.77
[SOURce]:DM:TRIGger:SOURce	EXTernal   INTernal	not-SCPI	3.77
[SOURce]:DM:TRIGger:INHibit	0 to 67.1E6	not-SCPI	3.77

Command	Parameter	SCPI Info	Page
[SOURce]:DM:TRIGger:DElay	0 to 65535	not-SCPI	3.77
[SOURce]:DM:TRIGger:SLOPe	POSitive   NEGative	not-SCPI	3.77
[SOURce]:DM:THReshold[:ALL]	-2,5 to 2,5 V		3.77
[SOURce]:DM:INPut:IMPedance	G1K   G50   ECL	not-SCPI	3.77
[SOURce]:FM1 2[:DEViation]	0 to 1 MHz		3.78
[SOURce]:FM1 2:EXTernal1 2:COUPling	AC   DC		3.78
[SOURce]:FM1 2:INTernal:FREQuency	0.1 Hz to 1 MHz		3.79
[SOURce]:FM1 2:PREEmphasis	0   50us   75us		3.79
[SOURce]:FM1 2:SOURce	INTernal   EXTernal1   EXTernal2		3.79
[SOURce]:FM1 2:STATe	ON   OFF		3.79
[SOURce]:FREQuency:CENTer	300 kHz to RF <sub>max</sub>		3.80
[SOURce]:FREQuency[:CW   :FIXed]	300 kHz to RF <sub>max</sub>		3.80
[SOURce]:FREQuency[:CW   :FIXed]:RCL	INCLude   EXCLude		3.80
[SOURce]:FREQuency:MANual	300 kHz to RF <sub>max</sub>		3.80
[SOURce]:FREQuency:MODE	CW   FIXed   SWEep   LIST		3.81
[SOURce]:FREQuency:OFFSet	-50 to +50 GHz		3.81
[SOURce]:FREQuency:SPAN	0 to RF <sub>max</sub>		3.81
[SOURce]:FREQuency:STARt	300 kHz to RF <sub>max</sub>		3.81
[SOURce]:FREQuency:STOP	300 kHz to RF <sub>max</sub>		3.81
[SOURce]:FREQuency:STEP[:INCRement]	0 to 1 GHz		3.81
[SOURce]:FSIMulator:ALL[:STATe]	ON   OFF	not-SCPI	3.84
[SOURce]:FSIMulator[:STATe]	ON   OFF	not-SCPI	3.84
[SOURce]:FSIMulator:CONFigure	S6Path   S12Path   D6Path	not-SCPI	3.84
[SOURce]:FSIMulator:SEQuence	RUN   STOP	not-SCPI	3.84
[SOURce]:FSIMulator:SEQuence:RESet		not-SCPI	3.84
[SOURce]:FSIMulator:IGNore:RFCHanges		not-SCPI	3.84
[SOURce]:FSIMulator:SPEed:UNIT	MPS   KMPH   MPH	not-SCPI	3.85
[SOURce]:FSIMulator:STANdard	CDMA8   CDMA30   CDMA100   NADC8   NADC50   NADC100   GTU3   GTU50   GHT100   GRA250   GET50   GET100   PTU1   PTU50   PTU100   PHT100   PRA130   PET50   PET100   TTU   THT   TET	not-SCPI	3.85
[SOURce]:FSIMulator:ILOSS:MODE	NORMal   LACP	not-SCPI	3.86
[SOURce]:FSIMulator:COUPlE:SPEed?	ON   OFF	not-SCPI	3.86
[SOURce]:FSIMulator:COUPlE:CORRelation:COEFFicient	ON   OFF	not-SCPI	3.86
[SOURce]:FSIMulator:COUPlE:LOGNormal:LCONstant	ON   OFF	not-SCPI	3.86
[SOURce]:FSIMulator:COUPlE:LOGNormal:CSTD	ON   OFF	not-SCPI	3.86
[SOURce]:FSIMulator:CFACTOR:EXTern?		not-SCPI	3.86
[SOURce]:FSIMulator:DEFault		not-SCPI	3.86
[SOURce]:FSIMulator:PATH<i>:STATE	ON   OFF	not-SCPI	3.87
[SOURce]:FSIMulator:PATH<i>:PROFile	PDOPpler   RAYLeigh   RICE   CPHase	not-SCPI	3.87
[SOURce]:FSIMulator:PATH<i>:DCOMponent:STATe	ON   OFF	not-SCPI	3.87
[SOURce]:FSIMulator:PATH<i>:PRATio	-30 to +30 dB	not-SCPI	3.87
[SOURce]:FSIMulator:PATH<i>:FRATio	-1.0 to +1.0	not-SCPI	3.87
[SOURce]:FSIMulator:PATH<i>:CPHase	0 to 360 DEG	not-SCPI	3.87
[SOURce]:FSIMulator:PATH<i>:SPEed	0.005 to 27777 (in MPS; m/s)	not-SCPI	3.87
[SOURce]:FSIMulator:PATH<i>:FDOPpler	0.1 to 1600 Hz	not-SCPI	3.87

Command	Parameter	SCPI Info	Page
[SOURce]:FSIMulator:PATH<i>:LOSS	0 to 50.0 dB	not-SCPI	3.87
[SOURce]:FSIMulator:PATH<i>:DELay	0 to 1638.0 E-6S	not-SCPI	3.88
[SOURce]:FSIMulator:PATH<i>:CORRelation:PATH	0   7 to 12	not-SCPI	3.88
[SOURce]:FSIMulator:PATH<i>:CORRelation:COEFFicient	0 to 1.0	not-SCPI	3.88
[SOURce]:FSIMulator:PATH<i>:CORRelation:PHASe	0 to 359 DEG	not-SCPI	3.88
[SOURce]:FSIMulator:PATH<i>:LOGNormal:STATe	ON   OFF	not-SCPI	3.88
[SOURce]:FSIMulator:PATH<i>:LOGNormal:LCONstant	0 to 99 999 (in m)	not-SCPI	3.88
[SOURce]:FSIMulator:PATH<i>:LOGNormal:CSTD	0 to 12.0 dB	not-SCPI	3.88
[SOURce]:FSIMulator:FDELay[:STATe]	ON   OFF	not-SCPI	3.88
[SOURce]:FSIMulator:FDELay:STANdard	G3C1   G3C2   G3C3   G3C4   G3UEC1   G3UEC2   G3UEC3   G3UEC4   G3UEC5   G3UEC6	not-SCPI	3.88
[SOURce]:FSIMulator:FDELay:SPEed:UNIT	MPS   KMPH   MPH	not-SCPI	3.89
[SOURce]:FSIMulator:FDELay:DEFault		not-SCPI	3.89
[SOURce]:FSIMulator:FDELay:PATH<i>:STATE	ON   OFF	not-SCPI	3.89
[SOURce]:FSIMulator:FDELay:PATH<i>:PROFile	PDOPpler   RAYLeigh	not-SCPI	3.89
[SOURce]:FSIMulator:FDELay:PATH<i>:FRATio	-1.0 to +1.0	not-SCPI	3.89
[SOURce]:FSIMulator:FDELay:PATH<i>:SPEed	0.005 to 27777 (in MPS; m/s)	not-SCPI	3.90
[SOURce]:FSIMulator:FDELay:PATH<i>:FDOPpler	0.1 to 1600 Hz	not-SCPI	3.90
[SOURce]:FSIMulator:FDELay:PATH<i>:LOSS	0 to 50.0 dB	not-SCPI	3.90
[SOURce]:FSIMulator:FDELay:PATH<i>:DELay	25ns to 1637us	not-SCPI	3.90
[SOURce]:FSIMulator:MDELay[:STATe]	ON   OFF	not-SCPI	3.90
[SOURce]:FSIMulator:MDELay:DEFault		not-SCPI	3.90
[SOURce]:FSIMulator:MDELay:REFerence:LOSS	0 to 50.0 dB	not-SCPI	3.90
[SOURce]:FSIMulator:MDELay:REFerence:DELay	0 to 1638.0 E-6S	not-SCPI	3.90
[SOURce]:FSIMulator:MDELay:MOVing:LOSS	0 to 50.0 dB	not-SCPI	3.91
[SOURce]:FSIMulator:MDELay:MOVing:DELay:MEAN	0.25us to 1637.8us	not-SCPI	3.91
[SOURce]:FSIMulator:MDELay:MOVing:DELay:VARiation	300ns to 100us	not-SCPI	3.91
[SOURce]:FSIMulator:MDELay:MOVing:VPERiod	10 to 500s	not-SCPI	3.91
[SOURce]:FSIMulator:BIRThdeath[:STATe]	ON   OFF	not-SCPI	3.91
[SOURce]:FSIMulator:BIRThdeath:ILOSs:MODE	NORMal   LACP	not-SCPI	3.91
[SOURce]:FSIMulator:BIRThdeath:DEFault		not-SCPI	3.91
[SOURce]:FSIMulator:BIRThdeath:PATH<i>:PROFile	PDOPpler	not-SCPI	3.92
[SOURce]:FSIMulator:BIRThdeath:PATH<i>:FRATio	-1.0 to +1.0	not-SCPI	3.92
[SOURce]:FSIMulator:BIRThdeath:PATH<i>:SPEed	0.005 to 27777 (in MPS; m/s)	not-SCPI	3.92
[SOURce]:FSIMulator:BIRThdeath:PATH<i>:FDOPpler	0.1 to 1600 Hz	not-SCPI	3.92
[SOURce]:FSIMulator:BIRThdeath:PATH<i>:LOSS	0 to 50.0 dB	not-SCPI	3.92
[SOURce]:FSIMulator:BIRThdeath:PATH<i>:DELay	5us to 1000s	not-SCPI	3.92
[SOURce]:FSIMulator:BIRThdeath:PATH<i>:HOPPing:DWELI	100ms to 5s	not-SCPI	3.92
[SOURce]:GPS:STATe	ON   OFF		3.93
[SOURce]:GPS:PRESet:STANdard		not-SCPI	3.93
[SOURce]:GPS:PRESet:RF		not-SCPI	3.94
[SOURce]:GPS:SEquence	AUTO   RETRigger   AAUTO   ARETrigger	not-SCPI	3.94
[SOURce]:GPS:TRIGger:SOURce	EXTernal   INTernal	not-SCPI	3.94
[SOURce]:GPS:TRIGger:DELay	0 to 20359	not-SCPI	3.94
[SOURce]:GPS:TRIGger:INHibit	0 to 67.1E6	not-SCPI	3.94

Command	Parameter	SCPI Info	Page
[:SOURce]:GPS:TRIGger:OUTPut[1]2:DELay	CODE   NBIT   NWORD   SFRame   FRAMe	not-SCPI	3.94
[:SOURce]:GPS:TRIGger:OUTPut[1]2:POLarity	POSitive   NEGative	not-SCPI	3.94
[:SOURce]:GPS:TRIGger:OUTPut[1]2:DELay	0 to 6137999	not-SCPI	3.94
[:SOURce]:GPS:CURRent: :FREQuency?		not-SCPI	3.94
[:SOURce]:GPS:CURRent:SRATe?	1kHz to 200 kHz	not-SCPI	3.95
[:SOURce]:GPS:DSHift	-10 kHz to 10 kHz	not-SCPI	3.95
[:SOURce]:GPS:SRATe	500000 to 1500000	not-SCPI	3.95
[:SOURce]:GPS:CODE	1 to 37	not-SCPI	3.95
[:SOURce]:GPS:DATA	PATtern   DLISt	not-SCPI	3.95
[:SOURce]:GPS:DATA:PATtern	#B0 to #B111..1, 1 to 24	not-SCPI	3.95
[:SOURce]:GPS:DATA:DLISt	'Datenliste-Name'	not-SCPI	3.95
[:SOURce]:GPS:DLISt:CATalog?		not-SCPI	3.95
[:SOURce]:GSM:STATe	ON   OFF	not-SCPI	3.97
[:SOURce]:GSM:STANdard		not-SCPI	3.97
[:SOURce]:GSM:FORMat	GMSK   GFSK	not-SCPI	3.97
[:SOURce]:GSM:FSK:DEViation	1kHz to 300 kHz	not-SCPI	3.97
[:SOURce]:GSM:SRATe	1kHz to 300 kHz	not-SCPI	3.97
[:SOURce]:GSM:FILTer:TYPE	GAUSs	not-SCPI	3.97
[:SOURce]:GSM:FILTer:PARAMeter	0.2 to 0.7	not-SCPI	3.98
[:SOURce]:GSM:SEQuence	AUTO   RETRigger   AAUTO   ARETrigger	not-SCPI	3.98
[:SOURce]:GSM:TRIGger:SOURce	EXTernal   INTernal	not-SCPI	3.98
[:SOURce]:GSM:TRIGger:INHibit	0 to 67.1E6	not-SCPI	3.98
[:SOURce]:GSM:TRIGger:DELay	0 to 65535	not-SCPI	3.98
[:SOURce]:GSM:TRIGger:OUTPut	SLOT   FRAME	not-SCPI	3.98
[:SOURce]:GSM:TRIGger:OUTPut[1]2:POLarity	POSitive   NEGative	not-SCPI	3.98
[:SOURce]:GSM:TRIGger:OUTPut[1]2:DELay	0 to 1249	not-SCPI	3.98
[:SOURce]:GSM:TRIGger:OUTPut[2]:PERiod	1 to 67.1E6	not-SCPI	3.98
[:SOURce]:GSM:CLOCK:SOURce	INTernal   EXTernal		3.98
[:SOURce]:GSM:CLOCK:DELay	0 to 1.0	not-SCPI	3.99
[:SOURce]:GSM:PRAMP:PRESet		not-SCPI	3.99
[:SOURce]:GSM:PRAMP:TIME	0.25 to 16.0	not-SCPI	3.99
[:SOURce]:GSM:PRAMP:DELay	-1.0 to +1.0	not-SCPI	3.99
[:SOURce]:GSM:PRAMP:SHAPE	LINear   COSine	not-SCPI	3.99
[:SOURce]:GSM:PRAMP:ROFFset	-9 to +9	not-SCPI	3.99
[:SOURce]:GSM:PRAMP:FOFFset	-9 to +9	not-SCPI	3.99
[:SOURce]:GSM:SLOT:ATTenuation	0 to 70 dB	not-SCPI	3.99
[:SOURce]:GSM:FLISt:PREDeFined:CATalog?		not-SCPI	3.100
[:SOURce]:GSM:FLISt:PREDeFined:LOAD	'Framelisten-Name'	not-SCPI	3.100
[:SOURce]:GSM:FLISt:CATalog?		not-SCPI	3.100
[:SOURce]:GSM:FLISt:LOAD	'Framelisten-Name'	not-SCPI	3.100
[:SOURce]:GSM:FLISt:STORE	'Framelisten-Name'	not-SCPI	3.100
[:SOURce]:GSM:FLISt:DELete	'Framelisten-Name'	not-SCPI	3.100
[:SOURce]:GSM:DLISt:CATalog?		not-SCPI	3.100
[:SOURce]:GSM:SLOT<i><->:TYPE	NORM   DUMMy   ADATa   EDGE	not-SCPI	3.100
[:SOURce]:GSM:SLOT<i><->:LEVel	OFF   ATT   FULL	not-SCPI	3.101
[:SOURce]:GSM:SLOT<i><->:PRESet		not-SCPI	3.101

Command	Parameter	SCPI Info	Page
[[:SOURce]:GSM:SLOT<i>]:HOPping:TRIGger	ON   OFF	not-SCPI	3.101
[[:SOURce]:GSM:SLOT<i>]:[:SOURce]:DATA	PN9   PN11   PN15   PN16   PN20   PN21   PN23   DLISt   SDATa	not-SCPI	3.101
[[:SOURce]:GSM:SLOT<i>]:[:SOURce]:DATA:DLISt	'name'	not-SCPI	3.101
[[:SOURce]:GSM:SLOT<i>]:SF	0   1	not-SCPI	3.101
[[:SOURce]:GSM:SLOT<i>]:TSC:SElect	T0 to T7   USER	not-SCPI	3.101
[[:SOURce]:GSM:SLOT<i>]:TSC:USER	#B0 to #B1111 to (26/78 bits)	not-SCPI	3.101
[[:SOURce]:IS95:STATe	ON   OFF	not-SCPI	3.103
[[:SOURce]:IS95:MODE	FLINK18   FLINK64   RLINk   RLCoded	not-SCPI	3.103
[[:SOURce]:IS95:PRESet		not-SCPI	3.103
[[:SOURce]:IS95:CRATe	1kHz to 7MHz	not-SCPI	3.103
[[:SOURce]:IS95:FILTer:FTYPE	SCOSine   COSine   IS95   EIS95   USER	not-SCPI	3.104
[[:SOURce]:IS95:FILTer:RTYPE	SCOSine   COSine   IS95   EIS95   USER	not-SCPI	3.104
[[:SOURce]:IS95:FILTer:FSElect	'name'	not-SCPI	3.104
[[:SOURce]:IS95:FILTer:RSElect	'name'	not-SCPI	3.104
[[:SOURce]:IS95:FILTer:PARAmeter	0.1 to 0.7	not-SCPI	3.104
[[:SOURce]:IS95:FILTer:MODE	LACP   LEVM	not-SCPI	3.104
[[:SOURce]:IS95:LDISortion[:STATe]	ON   OFF	not-SCPI	3.104
[[:SOURce]:IS95:SEQuence	AUTO   RETRIgger   AAUTO   ARETrigger	not-SCPI	3.105
[[:SOURce]:IS95:TRIGger:SOURce	EXTernal   INTernal	not-SCPI	3.105
[[:SOURce]:IS95:TRIGger:INHibit	0 to 65535	not-SCPI	3.105
[[:SOURce]:IS95:TRIGger:DELAy	0 to 65535	not-SCPI	3.105
[[:SOURce]:IS95:TRIGger:OUTPut[1]]2	FRame   SSRollover   SFRame   ESECond   GATE	not-SCPI	3.105
[[:SOURce]:IS95:TRIGger:OUTPut[1]]2:POLarity	POSITive   NEGative	not-SCPI	3.105
[[:SOURce]:IS95:TRIGger:OUTPut[1]]2:DELAy	-32768 to 32768	not-SCPI	3.105
[[:SOURce]:IS95:CLOCK:MODE	CHIP   CHIP4   CHIP8   CHIP16	not-SCPI	3.106
[[:SOURce]:IS95:CLOCK:SOURce	INTernal   EXTernal	not-SCPI	3.106
[[:SOURce]:IS95:CLOCK:DELAy	0 to 1.00	not-SCPI	3.106
[[:SOURce]:IS95:POWER?		not-SCPI	3.106
[[:SOURce]:IS95:POWER:ADJust		not-SCPI	3.106
[[:SOURce]:IS95:MAPPING:PREDefined:CATalog?		not-SCPI	3.106
[[:SOURce]:IS95:MAPPING:PREDefined:LOAD	'name'	not-SCPI	3.106
[[:SOURce]:IS95:MAPPING:CATalog?		not-SCPI	3.106
[[:SOURce]:IS95:MAPPING:LOAD	'name'	not-SCPI	3.107
[[:SOURce]:IS95:MAPPING:STORE	'name'	not-SCPI	3.107
[[:SOURce]:IS95:MAPPING:DELeTe	'name'	not-SCPI	3.107
[[:SOURce]:IS95:CHANnel<1...17>:WALShcode	0 to 63	not-SCPI	3.107
[[:SOURce]:IS95:CHANnel<0...3>:POWER	-30dB to 0dB	not-SCPI	3.107
[[:SOURce]:IS95:CHANnel<1...63>:DATA	ZERO   ONE   ALTErnate   PRBS	not-SCPI	3.107
[[:SOURce]:IS95:CHANnel<0...63>:STATe	ON   OFF	not-SCPI	3.107
[[:SOURce]:IS95:RATE	FULL   HALF	not-SCPI	3.108
[[:SOURce]:IS95:RANDomizer	ON   OFF	not-SCPI	3.108
[[:SOURce]:IS95:DATA	ZERO   ONE   ALTErnate   PRBS   DLISt	not-SCPI	3.108
[[:SOURce]:IS95:DLISt	'name'	not-SCPI	3.108
[[:SOURce]:IS95:DLISt:CATalog?		not-SCPI	3.108

Command	Parameter	SCPI Info	Page
[[:SOURce]:IS95:RLCoded:CType	TRAF14400   TRAF7200   TRAF3600   TRAF1800   ACC4800   TRAF9600   TRAF4800   TRAF2400   TRAF1200	not-SCPI	3.108
[[:SOURce]:IS95:RLCoded:DATA	PN9   PN11   PN15   PN16   PN20   PN 21   PN23   DLISt	not-SCPI	3.108
[[:SOURce]:IS95:RLCoded:DLISt	'name'	not-SCPI	3.108
[[:SOURce]:IS95:RLCoded:FQINdicator	ON   OFF	not-SCPI	3.108
[[:SOURce]:IS95:RLCoded:CENCoder	ON   OFF	not-SCPI	3.109
[[:SOURce]:IS95:RLCoded:BINTerleaver	ON   OFF	not-SCPI	3.109
[[:SOURce]:IS95:RLCoded:EBIT	0   1	not-SCPI	3.109
[[:SOURce]:LIST:CATalog?		not-SCPI	3.110
[[:SOURce]:LIST:DELeTe	'Listenname'	not-SCPI	3.110
[[:SOURce]:LIST:DELeTe:ALL		not-SCPI	3.110
[[:SOURce]:LIST:DWELI	1 ms to 1 s		3.110
[[:SOURce]:LIST:FREE?		not-SCPI	3.110
[[:SOURce]:LIST:FREQuency	300 kHz to RF <sub>max</sub> {, 300 kHz to RF <sub>max</sub> } block data		3.111
[[:SOURce]:LIST:FREQuency:POINts?			3.111
[[:SOURce]:LIST:LEARn		not-SCPI	3.111
[[:SOURce]:LIST:MODE	AUTO   STEP	not-SCPI	3.111
[[:SOURce]:LIST:POWer	-144 to 16 dBm {, -144 to 16 dBm}   block data		3.111
[[:SOURce]:LIST:POWer:POINts?			3.111
[[:SOURce]:LIST:SELeCt	'name'	not-SCPI	3.111
[[:SOURce]:MARKer1 2 3 4[:FSWeep]:AMPLitude	ON   OFF		3.112
[[:SOURce]:MARKer1 2 3 4[:FSWeep]:AOFF			3.112
[[:SOURce]:MARKer1 2 3 4[:FSWeep]:FREQuency	300 kHz to RF <sub>max</sub>		3.112
[[:SOURce]:MARKer1 2 3 4[:FSWeep][:STATe]	ON   OFF		3.113
[[:SOURce]:MARKer1 2 3 4:PSWeep:AOFF		not-SCPI	3.113
[[:SOURce]:MARKer1 2 3 4:PSWeep:POWer	-144 dBm to +16 dBm	not-SCPI	3.113
[[:SOURce]:MARKer1 2 3 4:PSWeep[:STATe]	ON   OFF	not-SCPI	3.113
[[:SOURce]:MARKer:POLarity	NORMal   INVerted	not-SCPI	3.113
[[:SOURce]:MODulation[ALL]:STATe	ON   OFF	not SCPI	3.114
[[:SOURce]:NADC:STATe	ON   OFF	not-SCPI	3.116
[[:SOURce]:NADC:STANdard		not-SCPI	3.116
[[:SOURce]:NADC:SRATE	1kHz to 200 kHz	not-SCPI	3.116
[[:SOURce]:NADC:FILTer:TYPE	SCOSine   COSine   USER	not-SCPI	3.117
[[:SOURce]:NADC:FILTer:SELeCt	'name'	not-SCPI	3.117
[[:SOURce]:NADC:FILTer:PARAmeter	0.1 to 0.7	not-SCPI	3.117
[[:SOURce]:NADC:FILTer:MODE	LACP   LEVM	not-SCPI	3.117
[[:SOURce]:NADC:LDIStortion[:STATe]	ON   OFF	not-SCPI	3.117
[[:SOURce]:NADC:SEQuence	AUTO   RETRigger   AAUTO   ARETrigger	not-SCPI	3.117
[[:SOURce]:NADC:TRIGger:SOURce	EXTernal   INTernal	not-SCPI	3.117
[[:SOURce]:NADC:TRIGger:INHibit	0 to 67.1E6	not-SCPI	3.117
[[:SOURce]:NADC:TRIGger:DELay	0 to 65535	not-SCPI	3.117
[[:SOURce]:NADC:TRIGger:OUTPut[1] 2:DELay	0 to 971	not-SCPI	3.118
[[:SOURce]:NADC:TRIGger:OUTPut[2]:PERiod	1 to 67.1E6	not-SCPI	3.118



Command	Parameter	SCPI Info	Page
[[:SOURce]:NADC:CLOCK:SOURce	INTernal   EXTernal		3.118
[[:SOURce]:NADC:CLOCK:MODE	BIT   SYMBol	not-SCPI	3.118
[[:SOURce]:NADC:CLOCK:DELay	0 to 1.0	not-SCPI	3.118
[[:SOURce]:NADC:PRAMP:PRESet		not-SCPI	3.118
[[:SOURce]:NADC:PRAMP:TIME	0.25 to 16.0	not-SCPI	3.118
[[:SOURce]:NADC:PRAMP:DELay	-1.0 to +1.0	not-SCPI	3.118
[[:SOURce]:NADC:PRAMP:SHAPE	LINear   COSine	not-SCPI	3.119
[[:SOURce]:NADC:PRAMP:ROFFset	-9 to +9	not-SCPI	3.119
[[:SOURce]:NADC:PRAMP:FOFFset	-9 to +9	not-SCPI	3.119
[[:SOURce]:NADC:SLOT:ATTenuation	0 to 70 dB	not-SCPI	3.119
[[:SOURce]:NADC:LINK	UP   DOWN	not-SCPI	3.119
[[:SOURce]:NADC:RCONfiguration	AHALf   FULL1   FULL2   FULL3   FULL12   FULL13   FULL23   AFUL	not-SCPI	3.119
[[:SOURce]:NADC:FLIST:PREDefined:CATalog?		not-SCPI	3.120
[[:SOURce]:NADC:FLIST:PREDefined:LOAD	'name'	not-SCPI	3.120
[[:SOURce]:NADC:FLIST:CATalog?		not-SCPI	3.120
[[:SOURce]:NADC:FLIST:LOAD	'name'	not-SCPI	3.120
[[:SOURce]:NADC:FLIST:STORE	'name'	not-SCPI	3.120
[[:SOURce]:NADC:FLIST:DELeTe	'name'	not-SCPI	3.120
[[:SOURce]:NADC:DLIST:CATalog?		not-SCPI	3.120
[[:SOURce]:NADC:SLOT<i>:LEVel	OFF   ATT   FULL	not-SCPI	3.121
[[:SOURce]:NADC:SLOT<i>:TYPE	TCH   SHORT   ADATa	not-SCPI	3.121
[[:SOURce]:NADC:SLOT<i>:PRESet		not-SCPI	3.121
[[:SOURce]:NADC:SLOT<i>[:SOURce]:SACChannel	PN9   PN11   PN15   PN16   PN20   PN21   PN23   DLIST   SDATa	not-SCPI	3.121
[[:SOURce]:NADC:SLOT<i>[:SOURce]:SACChannel:DLIST	'name'	not-SCPI	3.121
[[:SOURce]:NADC:SLOT<i>[:SOURce]:DATA	PN9   PN11   PN15   PN16   PN20   PN21   PN23   DLIST   SDATa	not-SCPI	3.121
[[:SOURce]:NADC:SLOT<i>[:SOURce]:DATA:DLIST	'name'	not-SCPI	3.122
[[:SOURce]:NADC:SLOT<i>:SYNC	#H0 to #HFFFFFF (28 bits)	not-SCPI	3.122
[[:SOURce]:NADC:SLOT<i>:CDVCC	#H0 to #HFFF (12 bits)	not-SCPI	3.122
[[:SOURce]:NADC:SLOT<i>:RSVD	#H800 to #HFFF (12 bits)	not-SCPI	3.122
[[:SOURce]:NOISE[:STATe]	ON   OFF	not-SCPI	3.123
[[:SOURce]:NOISE:SNRatio	5.0 to 30.0 dB	not-SCPI	3.123
[[:SOURce]:NOISE:BANDwidth	10000 to 10000000 Hz	not-SCPI	3.123
[[:SOURce]:PDC:STATe	ON   OFF	not-SCPI	3.125
[[:SOURce]:PDC:STANdard		not-SCPI	3.126
[[:SOURce]:PDC:SRATe	1kHz to 200 kHz	not-SCPI	3.126
[[:SOURce]:PDC:FILTer:TYPE	SCOSine   COSine   USER	not-SCPI	3.126
[[:SOURce]:PDC:FILTer:SElect	'name'	not-SCPI	3.126
[[:SOURce]:PDC:FILTer:PARAmeter	0.1..0.7	not-SCPI	3.126
[[:SOURce]:PDC:FILTer:MODE	LACP   LEVM	not-SCPI	3.126
[[:SOURce]:PDC:LDISortion[:STATe]	ON   OFF	not-SCPI	3.126
[[:SOURce]:PDC:SEQuence	AUTO   RETRigger   AAUTO   ARETrigger	not-SCPI	3.126
[[:SOURce]:PDC:TRIGger:SOURce	EXTernal   INTernal	not-SCPI	3.126
[[:SOURce]:PDC:TRIGger:INHibit	0 to 67.1E6	not-SCPI	3.127
[[:SOURce]:PDC:TRIGger:DELay	0 to 65535	not-SCPI	3.127

Command	Parameter	SCPI Info	Page
[[:SOURce]:PDC:TRIGger:OUTPut[1]]2:DELay	0 to 839	not-SCPI	3.127
[[:SOURce]:PDC:TRIGger:OUTPut[2]:PERiod	1 to 67.1E6	not-SCPI	3.127
[[:SOURce]:PDC:CLOCK:SOURce	INTernal   EXTernal		3.127
[[:SOURce]:PDC:CLOCK:MODE	BIT   SYMBol	not-SCPI	3.127
[[:SOURce]:PDC:CLOCK:DELay	0 to 1.0	not-SCPI	3.127
[[:SOURce]:PDC:PRAMp:PRESet		not-SCPI	3.127
[[:SOURce]:PDC:PRAMp:TIME	0.25 to 16.0	not-SCPI	3.128
[[:SOURce]:PDC:PRAMp:DELay	-1.0 to +1.0	not-SCPI	3.128
[[:SOURce]:PDC:PRAMp:SHAPE	LINear   COSine	not-SCPI	3.128
[[:SOURce]:PDC:PRAMp:ROFFset	-9 to +9	not-SCPI	3.128
[[:SOURce]:PDC:PRAMp:FOFFset	-9 to +9	not-SCPI	3.128
[[:SOURce]:PDC:SLOT:ATTenuation	0 to 70 dB	not-SCPI	3.128
[[:SOURce]:PDC:LINK	UP   DOWN	not-SCPI	3.128
[[:SOURce]:PDC:RCONfiguration	AHALf   FULL0   FULL1   FULL2   FULL10   FULL20   FULL21   AFUL	not-SCPI	3.128
[[:SOURce]:PDC:FLISt:PREDefined:CATalog?		not-SCPI	3.129
[[:SOURce]:PDC:FLISt:PREDefined:LOAD	'name'	not-SCPI	3.129
[[:SOURce]:PDC:FLISt:CATalog?		not-SCPI	3.129
[[:SOURce]:PDC:FLISt:LOAD	'name'	not-SCPI	3.129
[[:SOURce]:PDC:FLISt:STORe	'name'	not-SCPI	3.129
[[:SOURce]:PDC:FLISt:DELete	'name'	not-SCPI	3.129
[[:SOURce]:PDC:DLISt:CATalog?		not-SCPI	3.130
[[:SOURce]:PDC:SLOT<i>:TYPE	TCH   SYNC   VOX   ADATa	not-SCPI	3.130
[[:SOURce]:PDC:SLOT<i>:LEVel	OFF   ATT   FULL	not-SCPI	3.130
[[:SOURce]:PDC:SLOT<i>:PRESet		not-SCPI	3.130
[[:SOURce]:PDC:SLOT<i>:SCRamble:STATe	ON   OFF	not-SCPI	3.130
[[:SOURce]:PDC:SLOT<i>:SCRamble:STARt	#H1 to #H1FF (9 bit)	not-SCPI	3.130
[[:SOURce]:PDC:SLOT<i>:SFRame:STATe	ON   OFF	not-SCPI	3.131
[[:SOURce]:PDC:SLOT<i>:SFRame:RCHPosition	1 to 17	not-SCPI	3.131
[[:SOURce]:PDC:SLOT<i>[:SOURce]:DATA	PN9   PN11   PN15   PN16   PN20   PN21   PN23   DLISt   SDATa	not-SCPI	3.131
[[:SOURce]:PDC:SLOT<i>[:SOURce]:DATA:DLISt	'name'	not-SCPI	3.131
[[:SOURce]:PDC:SLOT<i>[:SOURce]:SACChannel	PN9   PN11   PN15   PN16   PN20   PN21   PN23   DLISt   SDATa	not-SCPI	3.131
[[:SOURce]:PDC:SLOT<i>[:SOURce]:SACChannel:DLISt	'Datenliste-Name'	not-SCPI	3.131
[[:SOURce]:PDC:SLOT<i>[:SOURce]:RCHannel	PN9   PN11   PN15   PN16   PN20   PN21   PN23   DLISt   SDATa	not-SCPI	3.131
[[:SOURce]:PDC:SLOT<i>[:SOURce]:RCHannel:DLISt	'name'	not-SCPI	3.132
[[:SOURce]:PDC:SLOT<i>[:SOURce]:SI	PN9   PN11   PN15   PN16   PN20   PN21   PN23   DLISt   SDATa	not-SCPI	3.132
[[:SOURce]:PDC:SLOT<i>[:SOURce]:SI:DLISt	'name'	not-SCPI	3.132
[[:SOURce]:PDC:SLOT<i>:PREamble	#H0 to #H to (2/6/48/102 bits)	not-SCPI	3.132
[[:SOURce]:PDC:SLOT<i>:SYNC	#H0 to #HFF (20/32bits)	not-SCPI	3.132
[[:SOURce]:PDC:SLOT<i>:SYNC2	#H0 to #HFF to (20/32 bits)	not-SCPI	3.132
[[:SOURce]:PDC:SLOT<i>:CCODE	#H0 to #HFF (8 bits)	not-SCPI	3.132
[[:SOURce]:PDC:SLOT<i>:POSTamble	#H0 to #H3FF to (78 bits)	not-SCPI	3.132
[[:SOURce]:PDC:SLOT<i>:SF	0   1	not-SCPI	3.132

Command	Parameter	SCPI Info	Page
[SOURce]:PHASe[:ADJust]	-360 deg to +360 deg		3.133
[SOURce]:PHASe:REFeRence			3.133
[SOURce]:PHS:STATe	ON   OFF	not-SCPI	3.135
[SOURce]:PHS:STANdard		not-SCPI	3.135
[SOURce]:PHS:SRATe	1kHz to 200 kHz	not-SCPI	3.135
[SOURce]:PHS:FILTer:TYPE	SCOSine   COSine   USER	not-SCPI	3.135
[SOURce]:PHS:FILTer:SElect	'name'	not-SCPI	3.136
[SOURce]:PHS:FILTer:PARAmeter	0.1 to 0.7	not-SCPI	3.136
[SOURce]:PHS:FILTer:MODE	LACP   LEVM	not-SCPI	3.136
[SOURce]:PHS:LDIStortion[:STATe]	ON   OFF	not-SCPI	3.136
[SOURce]:PHS:SEQuence	AUTO   RETRigger   AAUTo   ARETrigger	not-SCPI	3.136
[SOURce]:PHS:TRIGGer:SOURce	EXTeRnal   INTeRnal	not-SCPI	3.136
[SOURce]:PHS:TRIGGer:INHibit	0 to 67.1E6	not-SCPI	3.136
[SOURce]:PHS:TRIGGer:DELAy	0 to 65535	not-SCPI	3.136
[SOURce]:PHS:TRIGGer:OUTPut	SLOT   FRAME	not-SCPI	3.136
[SOURce]:PHS:TRIGGer:OUTPut[1]:POLarity	POSitive   NEGative	not-SCPI	3.136
[SOURce]:PHS:TRIGGer:OUTPut[2]:PERiod	1 to 67.1E6	not-SCPI	3.137
[SOURce]:PHS:CLOCK:SOURce	INTeRnal   EXTeRnal		3.137
[SOURce]:PHS:CLOCK:MODE	BIT   SYMBol	not-SCPI	3.137
[SOURce]:PHS:CLOCK:DELAy	0 to 1.0	not-SCPI	3.137
[SOURce]:PHS:PRAMp:PRESet		not-SCPI	3.137
[SOURce]:PHS:PRAMp:TIME	0.25 to 16.0	not-SCPI	3.137
[SOURce]:PHS:PRAMp:DELAy	-1.0 to +1.0	not-SCPI	3.137
[SOURce]:PHS:PRAMp:SHAPE	LINear   COSine	not-SCPI	3.138
[SOURce]:PHS:PRAMp:ROFFset	-9 to +9	not-SCPI	3.138
[SOURce]:PHS:PRAMp:FOFFset	-9 to +9	not-SCPI	3.138
[SOURce]:PHS:SLOT:ATTenuation	0 to 70 dB	not-SCPI	3.138
[SOURce]:PHS:FLISt:PREDeFined:CATalog?		not-SCPI	3.138
[SOURce]:PHS:FLISt:PREDeFined:LOAD	'name'	not-SCPI	3.138
[SOURce]:PHS:FLISt:CATalog?		not-SCPI	3.138
[SOURce]:PHS:FLISt:LOAD	'name'	not-SCPI	3.138
[SOURce]:PHS:FLISt:STORe	'name'	not-SCPI	3.138
[SOURce]:PHS:FLISt:DELeTe	'name'	not-SCPI	3.139
[SOURce]:PHS:DLISt:CATalog?		not-SCPI	3.139
[SOURce]:PHS:SLOT<i>:TYPE	TCHFull   TCHHalf   SYNC   VOX   ADATa	not-SCPI	3.139
[SOURce]:PHS:SLOT<i>:LEVel	OFF   ATT   FULL	not-SCPI	3.139
[SOURce]:PHS:SLOT<i>:PRESet		not-SCPI	3.139
[SOURce]:PHS:SLOT<i>:SCRamble:STATe	ON   OFF	not-SCPI	3.139
[SOURce]:PHS:SLOT<i>:SCRamble:CODE	#HO to #H3FF	not-SCPI	3.140
[SOURce]:PHS:SLOT<i>:ENCRyption:STATe	ON   OFF	not-SCPI	3.140
[SOURce]:PHS:SLOT<i>:ENCRyption:KEY	#HO to #HFFFF	not-SCPI	3.140
[SOURce]:PHS:SLOT<i>:UWORD	#HO to #HFFFFFFF	not-SCPI	3.140
[SOURce]:PHS:SLOT<i>:CSID	#HO to #H3FFFFFFF	not-SCPI	3.140
[SOURce]:PHS:SLOT<i>:PSID	#HO to #HFFFFFFF	not-SCPI	3.140
[SOURce]:PHS:SLOT<i>:IDLe	#HO to #H3FFFFFFF	not-SCPI	3.140
[SOURce]:PHS:SLOT<i>[:SOURce]:SACChannel	PN9   PN11   PN15   PN16   PN20   PN21	not-SCPI	3.140

Command	Parameter	SCPI Info	Page
	PN23   DLIS   SDATa		
[SOURce]:PHS:SLOT<i>[:SOURce]:SACChannel:DLIS	'name'	not-SCPI	3.141
[SOURce]:PHS:SLOT<i>[:SOURce]:TCHannel	PN9   PN11   PN15   PN16   PN20   PN21   PN23   DLIS   SDATa	not-SCPI	3.141
[SOURce]:PHS:SLOT<i>[:SOURce]:TCHannel:DLIS	'name'	not-SCPI	3.141
[SOURce]:PM1 2[:DEViation]	-360 to +360 deg		3.142
[SOURce]:PM1 2:EXTernal1  2:COUpling	AC   DC		3.142
[SOURce]:PM1 2:INTernal:FREQuency	0.1 Hz to 1 MHz		3.143
[SOURce]:PM1 2:SOURce	INTernal   EXTernal1   EXTernal2		3.143
[SOURce]:PM1 2:STATe	ON   OFF		3.143
[SOURce]:POWER:ALC:TABLE[:MEASure]?			3.144
[SOURce]:POWER:ALC[:STATe]	ON   OFF   AUTO		3.144
[SOURce]:POWER:ALC:SEARch	ON   OFF   ONCE		3.145
[SOURce]:POWER[:LEVel][:IMMediate][:AMPLitude]	-144 to +16 dBm		3.145
[SOURce]:POWER[:LEVel][:IMMediate]:OFFSet	-100 to +100 dB		3.145
[SOURce]:POWER[:LEVel][:IMMediate][:AMPL]:RCL	INCLude   EXCLude		3.145
[SOURce]:POWER:LIMit[:AMPLitude]	-144 to +16 dBm		3.145
[SOURce]:POWER:MANual	-144 to +16 dBm		3.146
[SOURce]:POWER:MODE	FIXed   SWEep   LIST		3.146
[SOURce]:POWER:PEP?			3.146
[SOURce]:POWER:STARt	-144 to +16 dBm		3.146
[SOURce]:POWER:STOP	-144 to +16 dBm		3.146
[SOURce]:POWER:STEP[:INCRement]	0.1 to 10 dB		3.146
[SOURce]:PULM:POLarity	NORMal   INVerted		3.147
[SOURce]:PULM:STATe	ON   OFF		3.147
[SOURce]:ROSCillator:EXTernal:FREQuency	1 to 16 MHz		3.148
[SOURce]:ROSCillator[:INTernal]:ADJust[:STATe]	ON   OFF	not-SCPI	3.148
[SOURce]:ROSCillator[:INTernal]:ADJust:VALue	0 to 4095	not-SCPI	3.148
[SOURce]:ROSCillator:SOURce	INTernal   EXTernal		3.148
[SOURce]:SWEep:BTIMe	NORMal   LONG	not-SCPI	3.149
[SOURce]:SWEep[:FREQuency]:DWELI	10 ms to 5 s	not-SCPI	3.149
[SOURce]:SWEep[:FREQuency]:MODE	AUTO   MANual   STEP	not-SCPI	3.149
[SOURce]:SWEep[:FREQuency]:POINts	Zahl	not-SCPI	3.150
[SOURce]:SWEep[:FREQuency]:SPACing	LINear   LOGarithmic	not-SCPI	3.150
[SOURce]:SWEep[:FREQuency]:STEP[:LINear]	0 to 1 GHz	not-SCPI	3.150
[SOURce]:SWEep[:FREQuency]:STEP:LOGarithmic	0.01 to 50 PCT	not-SCPI	3.150
[SOURce]:SWEep:POWER:DWELI	10 ms to 5 s	not-SCPI	3.150
[SOURce]:SWEep:POWER:MODE	AUTO   MANual   STEP	not-SCPI	3.151
[SOURce]:SWEep:POWER:POINts	Zahl	not-SCPI	3.151
[SOURce]:SWEep:POWER:STEP[:LOGarithmic]	0 to .10 dB	not-SCPI	3.151
[SOURce]:WCDMa:STATe	ON   OFF	not-SCPI	3.153
[SOURce]:WCDMa:MODE	CHAN4   CHAN8   CHAN15	not-SCPI	3.153
[SOURce]:WCDMa:PRESet		not-SCPI	3.153
[SOURce]:WCDMa:CRATE	R4M   R8M	not-SCPI	3.154
[SOURce]:WCDMa:LINK	DOWN   UP   UPMulti	not-SCPI	3.154
[SOURce]:WCDMa:FORMat	QPSK   OQPSK	not-SCPI	3.154

Command	Parameter	SCPI Info	Page
[SOURce]:WCDMa:CRATe:VARiation	100cps to 7.5Mcps	not-SCPI	3.154
[SOURce]:WCDMa:FILTer:TYPe	SCOSine   COSine   WCDMa   USER	not-SCPI	3.154
[SOURce]:WCDMa:FILTer:SElect	'name'	not-SCPI	3.154
[SOURce]:WCDMa:FILTer:PARAmeter	0.1 to 0.7	not-SCPI	3.154
[SOURce]:WCDMa:FILTer:MODE	LACP   LEVM	not-SCPI	3.154
[SOURce]:WCDMa:LDISortion[:STATe]	ON   OFF	not-SCPI	3.155
[SOURce]:WCDMa:SEquence	AUTO   RETRigger   AAUTo   ARETrigger	not-SCPI	3.155
[SOURce]:WCDMa:TRIGger:SOURce	EXTernal   INTernal	not-SCPI	3.155
[SOURce]:WCDMa:TRIGger:INHibit	0 to 67108863	not-SCPI	3.155
[SOURce]:WCDMa:TRIGger:DELay	0 to 40959	not-SCPI	3.155
[SOURce]:WCDMa:TRIGger:OUTPut[1]2	SLOT   RFRameCSPeriod	not-SCPI	3.155
[SOURce]:WCDMa:TRIGger:OUTPut[1]2:POLarity	POSitive   NEGative	not-SCPI	3.155
[SOURce]:WCDMa:TRIGger:OUTPut[1]2:DELay	0 to 40959 (81919)	not-SCPI	3.156
[SOURce]:WCDMa:CLOCK:SOURce	INTernal   EXTernal	not-SCPI	3.156
[SOURce]:WCDMa:POWer?		not-SCPI	3.156
[SOURce]:WCDMa:POWer:ADJust		not-SCPI	3.156
[SOURce]:WCDMa:MULTicode:STATe	ON   OFF63	not-SCPI	3.156
[SOURce]:WCDMa:MULTicode:MASTer	0 to 3	not-SCPI	3.156
[SOURce]:WCDMa:MULTicode:CHANnels	#H0 to # HFF	not-SCPI	3.156
[SOURce]:WCDMa:SLENgth	1 to 256	not-SCPI	3.156
[SOURce]:WCDMa:CHANnel<0...14>[:I]:Q:TYPE	PERCh   CCPCCh   DPCH   DPDCh   DPCCh   ALL	not-SCPI	3.157
[SOURce]:WCDMa:CHANnel<0...14>[:I]:Q:SRATe	D16   D32   D64   D128   D256   D512   D1024	not-SCPI	3.157
[SOURce]:WCDMa:CHANnel<0...14>[:I]:Q:SCODE	0 to 511	not-SCPI	3.157
[SOURce]:WCDMa:CHANnel<0...14>:LCODE	#H0 to #H3FFFF (#H1FFFFFFFF)	not-SCPI	3.157
[SOURce]:WCDMa:CHANnel<0...14>:LCODE:OFFSet	0 to 40959 (81919)	not-SCPI	3.157
[SOURce]:WCDMa:CHANnel<0...14>:SCODE:LMS	#H0 to #HFF	not-SCPI	3.158
[SOURce]:WCDMa:CHANnel<0...14>[:I]:Q:POWer	-30dB to 0dB	not-SCPI	3.158
[SOURce]:WCDMa:CHANnel<0...14>[:I]:Q:DATA	PN9   PN11   PN15   PN16   DLISt	not-SCPI	3.158
[SOURce]:WCDMa:CHANnel<0...14>[:I]:Q:DATA:DLISt	'name'	not-SCPI	3.158
[SOURce]:WCDMa:CHANnel<0...14>[:I]:Q:DATA:OFFSet	0 to 10239	not-SCPI	3.158
[SOURce]:WCDMa:CHANnel<1...14>:TPC	ZERO   ONE   ALTErnate   DLISt	not-SCPI	3.158
[SOURce]:WCDMa:CHANnel<1...14>:TPC:DLISt	'name'	not-SCPI	3.158
[SOURce]:WCDMa:CHANnel<0...14>:STATe	ON   OFF	not-SCPI	3.158
[SOURce]:W3GPP:CALCulate:PROGress?		not-SCPI	3.163
[SOURce]:W3GPP:STATe	ON   OFF	not-SCPI	3.163
[SOURce]:W3GPP:PRESet		not-SCPI	3.163
[SOURce]:W3GPP:SETTing:CATalog?		not-SCPI	3.163
[SOURce]:W3GPP:SETTing:LOAD	'name of sequence'	not-SCPI	3.163
[SOURce]:W3GPP:SETTing:STORe	'name of sequence'	not-SCPI	3.163
[SOURce]:W3GPP:SETTing:DELeTe	'name of sequence'	not-SCPI	3.164
[SOURce]:W3GPP:SETTing:TMODe[:BST]	'name'	not-SCPI	3.164
[SOURce]:W3GPP:SETTing:TMODe[:BST]		not-SCPI	3.164
[SOURce]:W3GPP:SETTing:TMODe:MST	'name'	not-SCPI	3.164
[SOURce]:W3GPP:SETTing:TMODe[:MST]		not-SCPI	3.164
[SOURce]:W3GPP:GPP3:VERSIon?		not-SCPI	3.164

Command	Parameter	SCPI Info	Page
[:SOURce]:W3GPP:CRATe?		not-SCPI	3.164
[:SOURce]:W3GPP:LINK	FORWard   REVerse	not-SCPI	3.165
[:SOURce]:W3GPP:SLENgth	1 to 13	not-SCPI	3.165
[:SOURce]:W3GPP:CLIPping:LEVel	1 to 100PCT	not-SCPI	3.165
[:SOURce]:W3GPP:FILTer:TYPe	SCOSine   COSine   WCDMa   USER	not-SCPI	3.165
[:SOURce]:W3GPP:FILTer:SElect	'name'	not-SCPI	3.165
[:SOURce]:W3GPP:FILTer:PARAmeter	0.1 to 0.99	not-SCPI	3.165
[:SOURce]:W3GPP:FILTer:MODE	LACP   LEVM	not-SCPI	3.166
[:SOURce]:W3GPP:CRATe:VARiation	100 Hz to 18 MHz	not-SCPI	3.166
[:SOURce]:W3GPP:PPARAmeter:SCHannels	ON   OFF	not-SCPI	3.166
[:SOURce]:W3GPP:PPARAmeter:SCCPch:STATe	ON   OFF	not-SCPI	3.166
[:SOURce]:W3GPP:PPARAmeter:SCCPch:SRATe	D15K   D30K   D60K   D120K   D240K   D480K   D960K	not-SCPI	3.166
[:SOURce]:W3GPP:PPARAmeter:DPCH:COUNT	0 to 512	not-SCPI	3.166
[:SOURce]:W3GPP:PPARAmeter:SRATe	D7K5   D15K   D30K   D60K   D120K   D240K   D480K   D960K	not-SCPI	3.166
[:SOURce]:W3GPP:PPARAmeter:CRESt	MINimum   AVERAge   WORSt	not-SCPI	3.166
[:SOURce]:W3GPP:PPARAmeter:EXECute		not-SCPI	3.166
[:SOURce]:W3GPP:COPIY:SOURce	1 to 4	not-SCPI	3.167
[:SOURce]:W3GPP:COPIY:DESTination	1 to 4	not-SCPI	3.167
[:SOURce]:W3GPP:COPIY:COFFset	0 to 511	not-SCPI	3.167
[:SOURce]:W3GPP:COPIY:EXECute		not-SCPI	3.167
[:SOURce]:W3GPP:SEQuence	AUTO   RETRigger   AAUTO   ARETrigger	not-SCPI	3.167
[:SOURce]:W3GPP:TRIGger:SOURce	EXTernal   INTernal	not-SCPI	3.167
[:SOURce]:W3GPP:TRIGger:DELay	0 to 38399	not-SCPI	3.167
[:SOURce]:W3GPP:TRIGger:INHibit	0 to 67108863	not-SCPI	3.167
[:SOURce]:W3GPP:TRIGger:OUTPut[1]2	SLOT   RFRame   CSPeriod   ECSPeriod   SFNR	not-SCPI	3.168
[:SOURce]:W3GPP:TRIGger:OUTPut[1]2:POLarity	POSitive   NEGative	not-SCPI	3.168
[:SOURce]:W3GPP:TRIGger:OUTPut[1]2:DELay	0 to 38399	not-SCPI	3.168
[:SOURce]:W3GPP:CLOCK:SOURce	INTernal   EXTernal	not-SCPI	3.168
[:SOURce]:W3GPP:CLOCK:MODE	CHIP   CHIP4	not-SCPI	3.168
[:SOURce]:W3GPP:CLOCK:DELay	0 to 0.99	not-SCPI	3.168
[:SOURce]:W3GPP:POWer?		not-SCPI	3.168
[:SOURce]:W3GPP:POWer:ADJust		not-SCPI	3.168
[:SOURce]:W3GPP:BSTation<i>:STATe	ON   OFF	not-SCPI	3.169
[:SOURce]:W3GPP:BSTation<i>:SCODE	#H0 to #H5FFF	not-SCPI	3.169
[:SOURce]:W3GPP:BSTation<i>:SCODE	ON   OFF	not-SCPI	3.169
[:SOURce]:W3GPP:BSTation<i>:TFCl	0 to 1023	not-SCPI	3.169
[:SOURce]:W3GPP:BSTation<i>:TFCl:STATe	ON   OFF	not-SCPI	3.169
[:SOURce]:W3GPP:BSTation<i>:SSCG?		not-SCPI	3.169
[:SOURce]:W3GPP:BSTation<i>:TPC:READ	CONTinuous   S0A   S1A   S01A   S10A	not-SCPI	3.169
[:SOURce]:W3GPP:BSTation<i>:TPC:MISuse	ON   OFF	not-SCPI	3.169
[:SOURce]:W3GPP:BSTation<i>:TPC:POWer:STEP	-10.0 to 10.0 dB	not-SCPI	3.169
[:SOURce]:W3GPP:BSTation<i>:TRANsmit:DIVersity	OFF   ANT1   ANT2	not-SCPI	3.170
[:SOURce]:W3GPP:BSTation:PINdicator:COUNT	D18   D36   D72   D144	not-SCPI	3.170
[:SOURce]:W3GPP:MCHannel:STARt	11 to 138	not-SCPI	3.170

Command	Parameter	SCPI Info	Page
[[:SOURce]:W3GPP:MCHannel:STOP	11 to 138	not-SCPI	3.170
[[:SOURce]:W3GPP:MCHannel:SRATe	D7K5   D15K   D30K   D60K   D120K   D240K   D480K   D960K	not-SCPI	3.170
[[:SOURce]:W3GPP:MCHannel:STOP	Bit2   Bit4   Bit8   Bit16	not-SCPI	3.170
[[:SOURce]:W3GPP:MCHannel:CCODE	0 to (511)	not-SCPI	3.170
[[:SOURce]:W3GPP:MCHannel:CCODE:STEP	0 to (511)	not-SCPI	3.170
[[:SOURce]:W3GPP:MCHannel:POWer	-60 dB to 0 dB	not-SCPI	3.170
[[:SOURce]:W3GPP:MCHannel:POWer:STEP	-60 dB to +60 dB	not-SCPI	3.171
[[:SOURce]:W3GPP:MCHannel:DATA	PN9   PN11   PN15   PN16   ZERO   ONE   PATTErn	not-SCPI	3.171
[[:SOURce]:W3GPP:MCHannel:DATA:PATTErn	##B0 to #B111..1, 1 to 24	not-SCPI	3.171
[[:SOURce]:W3GPP:MCHannel:TIMing:OFFSet	0 to 149	not-SCPI	3.171
[[:SOURce]:W3GPP:MCHannel:TIMing:OFFSet:STEP	0 to 149	not-SCPI	3.171
[[:SOURce]:W3GPP:MCHannel:TPC	ZERO   ONE   PATTErn	not-SCPI	3.171
[[:SOURce]:W3GPP:MCHannel:TPC:PATTErn	#B0 to #B111..1, 1 to 24	not-SCPI	3.171
[[:SOURce]:W3GPP:MCHannel:MCODE	ON   OFF	not-SCPI	3.171
[[:SOURce]:W3GPP:MCHannel:STATe	ON   OFF	not-SCPI	3.171
[[:SOURce]:W3GPP:BSTation<i>:MCHannel:EXECute		not-SCPI	3.172
[[:SOURce]:W3GPP:BSTation<i>:CHANnel<n>:SRATe	D7K5   D15K   D30K   D60K   D120K   D240K   D480K   D960K	not-SCPI	3.172
[[:SOURce]:W3GPP:BSTation<i>:CHANnel<n>:CCODE	0 to 511	not-SCPI	3.172
[[:SOURce]:W3GPP:BSTation<i>:CHANnel<n>:POWer	-60 dB to 0 dB	not-SCPI	3.172
[[:SOURce]:W3GPP:BSTation<i>:CHANnel<n>:DATA	PN9   PN11   PN15   PN16   ZERO   ONE   PATTErn	not-SCPI	3.172
[[:SOURce]:W3GPP:BSTation<i>:CHANnel<n>:DATA:PATTErn	#B0 to #B111..1, 1 to 24	not-SCPI	3.172
[[:SOURce]:W3GPP:BSTation<i>:CHANnel<n>:TOFFset	0 to 149	not-SCPI	3.173
[[:SOURce]:W3GPP:BSTation<i>:CHANnel<n>:TPC	ZERO   ONE   PATTErn	not-SCPI	3.173
[[:SOURce]:W3GPP:BSTation<i>:CHANnel<n>:PLENght	BIT2   BIT4   BIT8   BIT16   OFF	not-SCPI	3.173
[[:SOURce]:W3GPP:BSTation<i>:CHANnel<n>:TPC:PATTErn	#B0 to #B111..1, 1 to 24	not-SCPI	3.173
[[:SOURce]:W3GPP:BSTation<i>:CHANnel<n>:MCODE	ON   OFF	not-SCPI	3.173
[[:SOURce]:W3GPP:BSTation<i>:CHANnel<n>:STATe	ON   OFF	not-SCPI	3.173
[[:SOURce]:W3GPP :BSTation<i>:DOMain:ERRor?		not-SCPI	3.173
[[:SOURce]:W3GPP:MSTation<i>:STATe	ON   OFF	not-SCPI	3.173
[[:SOURce]:W3GPP:MSTation<i>:MODE	PRACH   PCPCh   DPCDch	not-SCPI	3.173
[[:SOURce]:W3GPP:MSTation<i>:SCODE	#H0 to #HFFFFFF	not-SCPI	3.174
[[:SOURce]:W3GPP:MSTation<i>:SCODE:MODE	LONG   SHORT   OFF	not-SCPI	3.174
[[:SOURce]:W3GPP:MSTation<i>:TPC:DATA	ZERO   ONE   PATTErn (  DLISt)	not-SCPI	3.174
[[:SOURce]:W3GPP:MSTation<i>:TPC:PATTErn	#B0 to #B111..1, 1 to 24	not-SCPI	3.174
[[:SOURce]:W3GPP:MSTation<i>:TPC:READ	CONTInuous   S0A   S1A   S01A   S10A	not-SCPI	3.174
[[:SOURce]:W3GPP:MSTation<i>:PRACH:PREPetition	1 to 10	not-SCPI	3.174
[[:SOURce]:W3GPP:MSTation<i>:PRACH:PPOWer	-60 to 0 dB	not-SCPI	3.174
[[:SOURce]:W3GPP:MSTation<i>:PRACH:DPOWer	-60 to 0 dB	not-SCPI	3.174
[[:SOURce]:W3GPP:MSTation<i>:PRACH:CPOWer	-60 to 0 dB	not-SCPI	3.175
[[:SOURce]:W3GPP:MSTation<i>:PRACH:MLENght	1   2	not-SCPI	3.175
[[:SOURce]:W3GPP:MSTation<i>:PRACH:SIGNature	0 to 15	not-SCPI	3.175
[[:SOURce]:W3GPP:MSTation<i>:PRACH:ASLot	0 to 14	not-SCPI	3.175
[[:SOURce]:W3GPP:MSTation<i>:PRACH:SRATe	D15K   D30K   D60K   D120K	not-SCPI	3.175

Command	Parameter	SCPI Info	Page
[:SOURce]:W3GPP:MSTation<i>:PRACH:DATA	PN9   PN11   PN15   PN16   ZERO   ONE   PATTErn	not-SCPI	3.175
[:SOURce]:W3GPP:MSTation<i>:PRACH:PATTErn	#B0 to #B111..1, 1 to 24	not-SCPI	3.175
[:SOURce]:W3GPP:MSTation<i>:PRACH:TFCI	0 to 1023	not-SCPI	3.175
[:SOURce]:W3GPP:MSTation<i>:PCPCh:PREPetition	0 to 10	not-SCPI	3.175
[:SOURce]:W3GPP:MSTation<i>:PCPCh:PPOWer	-60 to 0 dB	not-SCPI	3.176
[:SOURce]:W3GPP:MSTation<i>:PCPCh:PPOWer:STEP	0 to 10 dB	not-SCPI	3.176
[:SOURce]:W3GPP:MSTation<i>:PCPCh:DPOWer	-60 to 0 dB	not-SCPI	3.176
[:SOURce]:W3GPP:MSTation<i>:PCPCh:CPOWer	-60 to 0 dB	not-SCPI	3.176
[:SOURce]:W3GPP:MSTation<i>:PCPCh:MLENght	0 to 10	not-SCPI	3.176
[:SOURce]:W3GPP:MSTation<i>:PCPCh:PLENght	S0   S8	not-SCPI	3.176
[:SOURce]:W3GPP:MSTation<i>:PCPCh:SIGNature	0 to 15	not-SCPI	3.176
[:SOURce]:W3GPP:MSTation<i>:PCPCh:ASLot	0 to 14	not-SCPI	3.176
[:SOURce]:W3GPP:MSTation<i>:PCPCh:FBI:MODE	OFF   D1B   D2B	not-SCPI	3.176
[:SOURce]:W3GPP:MSTation<i>:PCPCh:FBI:DATA	ZERO   ONE   PATTErn	not-SCPI	3.176
[:SOURce]:W3GPP:MSTation<i>:PCPCh:FBI:PATTErn	#B0 to #B111..1, 1 to 24	not-SCPI	3.177
[:SOURce]:W3GPP:MSTation<i>:PCPCh:SRATe	D15K   D30K   D60K   D120K   D240K   D480K   D960K	not-SCPI	3.177
[:SOURce]:W3GPP:MSTation<i>:PCPCh:DATA	PN9   PN11   PN15   PN16   ZERO   ONE   PATTErn	not-SCPI	3.177
[:SOURce]:W3GPP:MSTation<i>:PCPCh:PATTErn	#B0 to #B111..1, 1 to 24	not-SCPI	3.177
[:SOURce]:W3GPP:MSTation<i>:PCPCh:TFCI	0 to 1023	not-SCPI	3.177
[:SOURce]:W3GPP:MSTation<i>:DPCCh:POWer	-60 to 0 dB	not-SCPI	3.177
[:SOURce]:W3GPP:MSTation<i>:DPCCh:TOFFset?		not-SCPI	3.177
[:SOURce]:W3GPP:MSTation<i>:DPCCh:TFCI	0 to 1023	not-SCPI	3.177
[:SOURce]:W3GPP:MSTation<i>:DPCCh:TFCI:STATe	ON   OFF	not-SCPI	3.178
[:SOURce]:W3GPP:MSTation<i>:DPCCh:FBI:MODE	OFF   D1B   D2B	not-SCPI	3.178
[:SOURce]:W3GPP:MSTation<i>:DPCCh:FBI:DATA	ZERO   ONE   PATTErn	not-SCPI	3.178
[:SOURce]:W3GPP:MSTation<i>:DPCCh:FBI:PATTErn	#B0 to #B111..1, 1 to 24	not-SCPI	3.178
[:SOURce]:W3GPP:MSTation<i>:DPCCh:TPC:MISSuse	ON   OFF	not-SCPI	3.178
[:SOURce]:W3GPP:MSTation<i>:DPCCh:TPC:PSTep	-10 to 10 dB	not-SCPI	3.178
[:SOURce]:W3GPP:MSTation<i>:DPDCh:ORATe	D15K   D30K   D60K   D120K   D240K   D480K   D960K   X2   X3   X4   X5   X6	not-SCPI	3.179
[:SOURce]:W3GPP:MSTation<i>:DPDCh:POWer	0 to 15	not-SCPI	3.179
[:SOURce]:W3GPP:MSTation<i>:DPDCh<j>:SRATe?	D15K   D30K   D60K   D120K   D240K   D480K   D960K	not-SCPI	3.179
[:SOURce]:W3GPP:MSTation<i>:DPDCh<j>:TYPE?		not-SCPI	3.179
[:SOURce]:W3GPP:MSTation<i>:DPDCh<j>:CCODE?		not-SCPI	3.179
[:SOURce]:W3GPP:MSTation<i>:DPDCh<j>:DATA	PN9   PN11   PN15   PN16   ZERO   ONE   PATTErn	not-SCPI	3.179
[:SOURce]:W3GPP:MSTation<i>:DPDCh<j>:PATTErn	#B0 to #B111..1, 1 to 24	not-SCPI	3.179
[:SOURce]:W3GPP:BSTation:ENHanced:STATe	ON   OFF	not-SCPI	3.183
[:SOURce]:W3GPP:BSTation:ENHanced:PCCPch[:STATe]	ON   OFF	not-SCPI	3.183
[:SOURce]:W3GPP:BSTation:ENHanced:CCODing:STATe	ON   OFF	not-SCPI	3.183
[:SOURce]:W3GPP:BSTation:ENHanced:CCODing:TYPE	M12K2   M64K   M144K   M384K   AMR	not-SCPI	3.183
[:SOURce]:W3GPP:BSTation:ENHanced:CCODing:INTerleaver[1]	ON   OFF	not-SCPI	3.183
[:SOURce]:W3GPP:BSTation:ENHanced:CCODing:INTerle	ON   OFF	not-SCPI	3.183



Command	Parameter	SCPI Info	Page
aver2			
[:SOURce]:W3GPP:BSTation:ENHanced:EPOWer:STATe	ON   OFF	not-SCPI	3.183
[:SOURce]:W3GPP:BSTation:ENHanced:EPOWer:STEP	0 to 6.0 dB	not-SCPI	3.183
[:SOURce]:W3GPP:BSTation:ENHanced:EPOWer:RANGe:UP	0 to 30.0 dB	not-SCPI	3.184
[:SOURce]:W3GPP:BSTation:ENHanced:EPOWer:RANGe:DOWN	0 to 30.0 dB	not-SCPI	3.184
[:SOURce]:W3GPP:BSTation:ENHanced:SLENgth	1 to (800)	not-SCPI	3.184
[:SOURce]:W3GPP:BSTation:ENHanced:SLENgth:FREE?		not-SCPI	3.184
[:SOURce]:W3GPP:BSTation:ENHanced:PCCPch:SLENgth		not-SCPI	3.184
[:SOURce]:W3GPP:BSTation:ENHanced:SRATe	D7K5   D15K   D30K   D60K   D120K   D240K   D480K   D960K	not-SCPI	3.184
[:SOURce]:W3GPP:BSTation:ENHanced:TOFFset	0 to 149	not-SCPI	3.184
[:SOURce]:W3GPP:BSTation:ENHanced:PLENgth	BIT2   BIT4   BIT8   BIT16	not-SCPI	3.184
[:SOURce]:W3GPP:BSTation:ENHanced:DERRor:BIT:STATe	ON   OFF	not-SCPI	3.184
[:SOURce]:W3GPP:BSTation:ENHanced:DERRor:BIT:RATE	1E-1 to 1E-7	not-SCPI	3.184
[:SOURce]:W3GPP:BSTation:ENHanced:DERRor:BIT:DPCH?		not-SCPI	3.184
[:SOURce]:W3GPP:BSTation:ENHanced:DERRor:BIT:DTCH?		not-SCPI	3.185
[:SOURce]:W3GPP:BSTation:ENHanced:DERRor:BIT:DCCH?		not-SCPI	3.185
[:SOURce]:W3GPP:BSTation:ENHanced:DERRor:BLOCK:STATe	ON   OFF	not-SCPI	3.185
[:SOURce]:W3GPP:BSTation:ENHanced:DERRor:BLOCK:RATE	1E-1 to 1E-7	not-SCPI	3.185
[:SOURce]:W3GPP:BSTation:ENHanced:DERRor:BLOCK:DTCH?		not-SCPI	3.185
[:SOURce]:W3GPP:BSTation:ENHanced:DERRor:BLOCK:DCCH?		not-SCPI	3.185
[:SOURce]:W3GPP:BSTation:ENHanced:CHANnel<i></i>:STATe	ON   OFF	not-SCPI	3.185
[:SOURce]:W3GPP:BSTation:ENHanced:CHANnel<i></i>:CHN Code	0 to (511)	not-SCPI	3.185
[:SOURce]:W3GPP:BSTation:ENHanced:CHANnel<i></i>:POWer:STARt	-60.0 to 0 dB	not-SCPI	3.185
[:SOURce]:W3GPP:BSTation:ENHanced:CHANnel<i></i>:POWer:CONTRol	OFF   UP   DOWN	not-SCPI	3.186
[:SOURce]:W3GPP:BSTation:ENHanced:CHANnel<i></i>:DATA	PN9   PN11   PN15   PN16   ZERO   ONE   PATTErn   DLISt	not-SCPI	3.186
[:SOURce]:W3GPP:BSTation:ENHanced:CHANnel<i></i>:DATA:PATTErn	#B0 to #B111..1, 1 to 24	not-SCPI	3.186
[:SOURce]:W3GPP:BSTation:ENHanced:CHANnel<i></i>:DATA:DSElect	'name'	not-SCPI	3.186
[:SOURce]:W3GPP:BSTation:ENHanced:CHANnel<i></i>:DTC H	PN9   PN11   PN15   PN16   ZERO   ONE   PATTErn   DLISt	not-SCPI	3.186
[:SOURce]:W3GPP:BSTation:ENHanced:CHANnel<i></i>:DTC H:PATTErn	#B0 to #B111..1, 1 to 24	not-SCPI	3.186
[:SOURce]:W3GPP:BSTation:ENHanced:CHANnel<i></i>:DTC H:DSElect	'name'	not-SCPI	3.186
[:SOURce]:W3GPP:BSTation:ENHanced:CHANnel<i></i>:DCCH	PN9   PN11   PN15   PN16   ZERO   ONE   PATTErn   DLISt	not-SCPI	3.186
[:SOURce]:W3GPP:BSTation:ENHanced:CHANnel<i></i>:DCC H:PATTErn	#B0 to #B111..1, 1 to 24	not-SCPI	3.187
[:SOURce]:W3GPP:BSTation:ENHanced:CHANnel<i></i>:DCC H:DSElect	'name'	not-SCPI	3.187

Command	Parameter	SCPI Info	Page
[[:SOURce]:W3GPP:BSTation:ENHanced:CHANnel<i>]:TPC	ZERO   ONE   PATTErn   DLISt	not-SCPI	3.187
[[:SOURce]:W3GPP:BSTation:ENHanced:CHANnel<i>]:TPC :PATTErn	#B0 to #B111..1, 1 to 24	not-SCPI	3.187
[[:SOURce]:W3GPP:BSTation:ENHanced:CHANnel<i>]:TPC :DSElect	'name'	not-SCPI	3.187
[[:SOURce]:W3GPP:BSTation:ENHanced:CHANnel<i>]:MCODe	ON   OFF	not-SCPI	3.187
[[:SOURce]:W3GPP:BSTation:OCNS:STATe	ON   OFF	not-SCPI	3.187
[[:SOURce]:W3GPP:BSTation:OCNS:COUNt	1 to (508)	not-SCPI	3.188
[[:SOURce]:W3GPP:BSTation:OCNS:SRATe	D7K5   D15K   D30K   D60K   D120K   D240K   D480K   D960K	not-SCPI	3.188
[[:SOURce]:W3GPP:BSTation:OCNS:CRESt	MINimum   AVERAge   WORSt	not-SCPI	3.188
[[:SOURce]:W3GPP:BSTation:OCNS:POWEr	-60.0 to 0 dB	not-SCPI	3.188
[[:SOURce]:W3GPP:BSTation:OCNS:PCCPch:STATe	ON   OFF	not-SCPI	3.188
[[:SOURce]:W3GPP:BSTation:OCNS:PCCPch:POWEr	-60.0 to 0dB	not-SCPI	3.188
[[:SOURce]:W3GPP:BSTation:OCNS:EPOWEr	-60.0 to 0 dB	not-SCPI	3.188
[[:SOURce]:W3GPP:BSTation:OCNS:EXECute		not-SCPI	3.188
[[:SOURce]:W3GPP:MSTation:ENHanced:STATe	ON   OFF	not-SCPI	3.188
[[:SOURce]:W3GPP:MSTation:ENHanced:CCODing:STATe	ON   OFF	not-SCPI	3.189
[[:SOURce]:W3GPP:MSTation:ENHanced:CCODing:TYPE	M12K2   M64K   M144K   M384K   AMR	not-SCPI	3.189
[[:SOURce]:W3GPP:MSTation:ENHanced:CCODing:INTerle aver[1]	ON   OFF	not-SCPI	3.189
[[:SOURce]:W3GPP:MSTation:ENHanced:CCODing:INTerle aver2	ON   OFF	not-SCPI	3.189
[[:SOURce]:W3GPP:MSTation:ENHanced:EPOWEr:STATe	ON   OFF	not-SCPI	3.189
[[:SOURce]:W3GPP:MSTation:ENHanced:EPOWEr:STEP	0 to 6.0 dB	not-SCPI	3.189
[[:SOURce]:W3GPP:MSTation:ENHanced:EPOWEr:RANGE :UP	0 to 30.0 dB	not-SCPI	3.189
[[:SOURce]:W3GPP:MSTation:ENHanced:EPOWEr:RANGE :DOWN	0 to 30.0 dB	not-SCPI	3.189
[[:SOURce]:W3GPP:MSTation:ENHanced:SLENGth	1 to (800)	not-SCPI	3.189
[[:SOURce]:W3GPP:MSTation:ENHanced:SLENGth:FREE?		not-SCPI	3.189
[[:SOURce]:W3GPP:MSTation:ENHanced:ORATe	D15K   D30K   D60K   D120K   D240K   D480K   D960K   X2   X3   X4   X5   X6	not-SCPI	3.190
[[:SOURce]:W3GPP:MSTation:ENHanced:DPCCh:STATe	ON   OFF	not-SCPI	3.190
[[:SOURce]:W3GPP:MSTation:ENHanced:POWEr:DPCCh	0 to -60.0 dB	not-SCPI	3.190
[[:SOURce]:W3GPP:MSTation:ENHanced:POWEr:DPDCh	0 to -60.0 dB	not-SCPI	3.190
[[:SOURce]:W3GPP:MSTation:ENHanced:DERRor:BIT:STATe	ON   OFF	not-SCPI	3.190
[[:SOURce]:W3GPP:MSTation:ENHanced:DERRor:BIT:RATE	1E-1 to 1E-7	not-SCPI	3.190
[[:SOURce]:W3GPP:MSTation:ENHanced:DERRor:BIT:DP DCh		not-SCPI	3.190
[[:SOURce]:W3GPP:MSTation:ENHanced:DERRor:BIT:DTCH?		not-SCPI	3.190
[[:SOURce]:W3GPP:MSTation:ENHanced:DERRor:BIT :DCCH?		not-SCPI	3.190
[[:SOURce]:W3GPP:MSTation:ENHanced:DERRor:BLOCK: STATe	ON   OFF	not-SCPI	3.190
[[:SOURce]:W3GPP:MSTation:ENHanced:DERRor:BLOCK: RATE	1E-1 to 1E-7	not-SCPI	3.190
[[:SOURce]:W3GPP:MSTation:ENHanced:DERRor:BLOCK :DTCH?		not-SCPI	3.191
[[:SOURce]:W3GPP:MSTation:ENHanced:DERRor:BLOCK :DCCH?		not-SCPI	3.191

Command	Parameter	SCPI Info	Page
[:SOURce]:W3Gpp:MSTation:ENHanced:CHANnel<i>:SRATe?		not-SCPI	3.191
[:SOURce]:W3Gpp:MSTation:ENHanced:CHANnel<i>:CHNCode?		not-SCPI	3.191
[:SOURce]:W3Gpp:MSTation:ENHanced:CHANnel<i>:DATA	PN9   PN11   PN15   PN16   ZERO   ONE   PATTErn   DLISt	not-SCPI	3.191
[:SOURce]:W3Gpp:MSTation:ENHanced:CHANnel<i>:DATA:PA TTern	#B0 to #B111..1, 1 to 24	not-SCPI	3.191
[:SOURce]:W3Gpp:MSTation:ENHanced:CHANnel<i>:DAT A:DSElect	'name'	not-SCPI	3.191
[:SOURce]:W3Gpp:MSTation:ENHanced:CHANnel<i>:DTCH	PN9   PN11   PN15   PN16   ZERO   ONE   PATTErn   DLISt	not-SCPI	3.192
[:SOURce]:W3Gpp:MSTation:ENHanced:CHANnel<i>:DTC H:PATTErn	#B0 to #B111..1, 1 to 24	not-SCPI	3.192
[:SOURce]:W3Gpp:MSTation:ENHanced:CHANnel<i>:DTCH:DSElect	'name'	not-SCPI	3.192
[:SOURce]:W3Gpp:MSTation:ENHanced:CHANnel<i>:DCCH	PN9   PN11   PN15   PN16   ZERO   ONE   PATTErn   DLISt	not-SCPI	3.192
[:SOURce]:W3Gpp:MSTation:ENHanced:CHANnel<i>:DC CH:PATTErn	#B0 to #B111..1, 1 to 24	not-SCPI	3.192
[:SOURce]:W3Gpp:MSTation:ENHanced:CHANnel<i>:DC CH:DSElect	'name'	not-SCPI	3.192
[:SOURce]:W3Gpp:MSTation:ADDITIONal:STATe	ON   OFF	not-SCPI	3.192
[:SOURce]:W3Gpp:MSTation:ADDITIONal:COUNT	1 to 50	not-SCPI	3.193
[:SOURce]:W3Gpp:MSTation:ADDITIONal:SCODE:STEP	#H1 to #H1000	not-SCPI	3.193
[:SOURce]:W3Gpp:MSTation:ADDITIONal:POWER:OFFset	-20.0 to 20.0 dB	not-SCPI	3.193
:SOURce2:FREQuency[:CW   :FIXed]	0.1 Hz to 1 MHz		3.194
:SOURce2:FREQuency:MANual	0.1 Hz to 1 MHz		3.194
:SOURce2:FREQuency:MODE	CW FIXed   SWEep		3.195
:SOURce2:FREQuency:START	0.1 Hz to 1 MHz		3.195
:SOURce2:FREQuency:STOP	0.1 Hz to 1 MHz		3.195
:SOURce2:MARKer1 2 3[:FSWep]:AOFF			3.196
:SOURce2:MARKer1 2 3[:FSWep]:FREQuency	0.1 Hz to 1 MHz		3.196
:SOURce2:MARKer1 2 3[:FSWep][::STATe]	ON   OFF		3.196
:SOURce2:MARKer1 2 3:POLarity	NORMal   INVerted	not-SCPI	3.196
:SOURce2:SWEep:BTIme	NORMal   LONG	not-SCPI	3.197
:SOURce2:SWEep[:FREQuency]:DWELI	1 ms to 1 s	not-SCPI	3.197
:SOURce2:SWEep[:FREQuency]:MODE	AUTO   MANual   STEP	not-SCPI	3.197
:SOURce2:SWEep[:FREQuency]:POINTs	Zahl	not-SCPI	3.198
:SOURce2:SWEep[:FREQuency]:SPACing	LINear   LOGarithmic	not-SCPI	3.198
:SOURce2:SWEep[:FREQuency]:STEP[:LINear]	0 to 500 kHz	not-SCPI	3.198
:SOURce2:SWEep[:FREQuency]:STEP:LOGarithmic	0.01 to 50 PCT	not-SCPI	3.198
:STATus:OPERation[:EVENT]?			3.199
:STATus:OPERation:CONDition?			3.199
:STATus:OPERation:PTRansition	0 to 32767		3.199
:STATus:OPERation:NTRansition	0 to 32767		3.199
:STATus:OPERation:ENABLE	0 to 32767		3.200
:STATus:PRESet			3.200
:STATus:QUEStionable[:EVENT]?			3.200
:STATus:QUEStionable:CONDition?			3.200

Command	Parameter	SCPI Info	Page
:STATus:QUEStionable:PTRansition	0 to 32767		3.200
:STATus:QUEStionable:NTRansition	0 to 32767		3.200
:STATus:QUEStionable:ENABle	0 to 32767		3.200
:STATus:QUEue [:NEXT]?			3.200
:SYSTem:BEEPer:STATe	ON   OFF		3.202
:SYSTem:COMMunicate:GPIB:LTERminator	EOI   STANDard		3.202
:SYSTem:COMMunicate:GPIB[:SELF]:ADDResS	1 to 30		3.202
:SYSTem:COMMunicate:SDATa:BAUD	1200  2400  4800  9600  19200  38400  57600  115200		3.202
:SYSTem:COMMunicate:SERial:BAUD	1200  2400  4800  9600  19200  38400  57600  115200		3.202
:SYSTem:COMMunicate:SERial:CONTRol:RTS	ON   IBFull   RFR		3.202
:SYSTem:COMMunicate:SERial:PACe	XON   NONE		3.203
:SYSTem:ERRor?			3.203
:SYSTem:KLOCK	ON   OFF		3.203
:SYSTem:MODE	FIXed   MSEquence	not-SCPI	3.203
:SYSTem:MSEquence:CATalog?		not-SCPI	3.203
:SYSTem:MSEquence:DELeTe	' name of sequence '	not-SCPI	3.204
:SYSTem:MSEquence:DELeTe:ALL		not-SCPI	3.204
:SYSTem:MSEquence:DWELI	50 ms to 60 s{,50 ms to 60 s}	not-SCPI	3.204
:SYSTem:MSEquence:FREE?		not-SCPI	3.204
:SYSTem:MSEquence:MODE	AUTO   STEP	not-SCPI	3.204
:SYSTem:MSEquence[:RCL]	1 to 50 {,1 to 50}	not-SCPI	3.204
:SYSTem:MSEquence[:RCL]:POINts?		not-SCPI	3.205
:SYSTem:MSEquence:SELeCt	' name of sequence '	not-SCPI	3.205
:SYSTem:PRESet			3.205
:SYSTem:PROTeCt[:STATe]	ON   OFF, PassworT	not-SCPI	3.205
:SYSTem:SECurity[:STATe]	ON   OFF		3.205
:SYSTem:SERRor?		not-SCPI	3.206
:SYSTem:VERSIon?			3.206
:SYSTem:SSAVe	1 to 1000	not-SCPI	3.206
:SYSTem:SREStore	1 to 1000	not-SCPI	3.206
!	<least sign. byte><most sign. byte>	not-SCPI	3.206
:TEST:DIRect:ATTC	Subaddress {,hex data string}		3.208
:TEST:DIRect:DGEn	Subaddress {,hex data string}		3.208
:TEST:DIRect:DSYN0MUX	Subaddress {,hex data string}		3.208
:TEST:DIRect:DSYN1MUX	Subaddress {,hex data string}		3.208
:TEST:DIRect:FMOD	Subaddress {,hex data string}		3.208
:TEST:DIRect:FSIM1M	Subaddress {,hex data string}		3.208
:TEST:DIRect:FSIM2M	Subaddress {,hex data string}		3.208
:TEST:DIRect:IQCON	Subaddress {,hex data string}		3.208
:TEST:DIRect:IQMOD	Subaddress {,hex data string}		3.208
:TEST:DIRect:MCOD	Subaddress {,hex data string}		3.208
:TEST:DIRect:NDSim	Subaddress {,hex data string}		3.208
:TEST:DIRect:REFSS	Subaddress {,hex data string}		3.208
:TEST:DIRect:ROSC	Subaddress {,hex data string}		3.208

Command	Parameter	SCPI Info	Page
:TEST:DIRect:SUM	Subaddress {,hex data string}		3.208
:TEST:MCOD?			3.209
:TEST:BERT?			3.209
:TEST:FSIM?			3.209
:TEST:RAM?			3.209
:TEST:ROM?			3.209
:TEST:BATTery[:RAM]?			3.209
:TEST:BATTery:DGEN?			3.209
:TRIGger1 2[:SWEep][:IMMEDIATE]		not-SCPI	3.210
:TRIGger1 2[:SWEep]:SOURce	AUTO   SINGLE   EXTERNAL	not-SCPI	3.211
:TRIGger:BERT[:IMMEDIATE]		not-SCPI	3.211
:TRIGger:BERT[:IMMEDIATE]		not-SCPI	3.211
:TRIGger:LIST[:IMMEDIATE]		not-SCPI	3.211
:TRIGger:LIST:SOURce	AUTO   SINGLE   EXTERNAL   HO	not-SCPI	3.212
:TRIGger:DM[:IMMEDIATE]		not-SCPI	3.212
:TRIGger:DM:SOURce	AUTO   SINGLE   EXTERNAL	not-SCPI	3.212
:TRIGger:MSEquence[:IMMEDIATE]		not-SCPI	3.213
:TRIGger:MSEquence:SOURce	SINGLE   EXTERNAL   AUTO	not-SCPI	3.213
:TRIGger:SLOPe	POSITIVE   NEGATIVE	not-SCPI	3.213
:UNIT:ANGLE	DEGREE   DEGREE   RADIAN		3.214
:UNIT:POWER	DBM   DBW   DBMW   DBUW   DBV   DBMV   DBUV   V		3.214

## D Annex D

### D.1 Programming Examples

The examples explain the programming of the instrument and can serve as a basis to solve more complex programming tasks.

QuickBASIC has been used as programming language. However, the programs can be translated into other languages.

#### 1. Including IEC-Bus Library for QuickBasic

```
REM ----- Include IEC-bus library for quickbasic -----
'$INCLUDE: 'c:\qbasic\qbdecl4.bas
```

#### 2. Initialization and Default Status

The IEC bus as well as the settings of the instrument are brought into a defined default status at the beginning of every program. Subroutines "InitController" and "InitDevice" are used to this effect.

##### 2.1. Initiate Controller

```
REM ----- Initiate Instrument -----
REM InitController
ieaddress% = 28                                'IEC-bus address of the instrument
CALL IBFIND("DEV1", generator%)                'Open port to the instrument
CALL IBPAD(generator%, ieaddress%)             'Inform controller on instrument address
CALL IBTMO(generator%, 11)                     'Response time to 1 sec
REM *****
```

##### 2.2. Initiate Instrument

The IEC-bus status registers and instrument settings of the SMIQ are brought into the default status.

```
REM ----- Initiate Instrument -----
REM InitDevice
CALL IBWRT(generator%, "*CLS")                 'Reset status register
CALL IBWRT(generator%, "*RST")                 'Reset instrument
CALL IBWRT(generator%, "OUTPUT ON")           'Switch on RF output
REM*****
```

### 3. Transmission of Instrument Setting Commands

Output frequency, output level and AM modulation are set in this example. The settings correspond to the sample setting for first users in manual control. By analogy to the step width setting of the rotary knob, the step width is additionally set for the alteration of the RF frequency in the case of UP and DOWN.

```
REM ----- Instrument setting commands -----
CALL IBWRT(generator%, "FREQUENCY 250E6")           'RF Frequency 250 MHz
CALL IBWRT(generator%, "POWER -10")                'Output power -10 dBm
CALL IBWRT(generator%, "AM 80")                    'AM with modulation index of 80%
CALL IBWRT(generator%, "AM:INTERNAL1:FREQUENCY 3KHZ") 'Modulation frequency 3kHz
CALL IBWRT(generator%, "AM:SOURCE INT")            'Modulation source LF generator 1
CALL IBWRT(generator%, "FREQUENCY:STEP 12500")     'Step width RF frequency 12.5kHz
REM *****
```

### 4. Switchover to Manual Control

```
REM ----- Switch instrument over to manual control -----
CALL IBLOC(generator%)                             'Set instrument to Local state
REM *****
```

### 5. Reading out Instrument Settings

The settings made in example 3 are read out here. The abbreviated commands are used.

```
REM ----- Reading out instrument settings -----
Rffrequency$ = SPACE$(20)                          'Provide text variables with 20 characters
CALL IBWRT(generator%, "FREQ?")                     'Request frequency setting
CALL IBRD(generator%, Rffrequency$)                 'Read value

Rflevel$ = SPACE$(20)                              'Provide text variables with 20 characters
CALL IBWRT(generator%, "POW?")                      'Request level setting
CALL IBRD(generator%, Rflevel$)                     'Read value

AMmodulationdepth$ = SPACE$(20)                    'Provide text variables with 20 characters
CALL IBWRT(generator%, "AM?")                       'Request setting of modulation depth
CALL IBRD(generator%, AMmodulationdepth$)           'Read value

AMfrequency$ = SPACE$(20)                          'Provide text variables with 20 characters
CALL IBWRT(generator%, "AM:INT:FREQ?")              'Request modulation frequency setting
CALL IBRD(generator%, AMfrequency$)                 'Read value

Stepwidth$ = SPACE$(20)                            'Provide text variables with 20 characters
CALL IBWRT(generator%, "FREQ:STEP?")                'Request step width setting
CALL IBRD(generator%, stepwidth$)                   'Read value

REM ----- Display values on the screen -----
PRINT "RF frequency:      "; Rffrequency$,
PRINT "RF level:         "; Rflevel$,
PRINT "AM modulationdepth: "; AMmodulationdepth$,
PRINT "AM frequency:     "; AMfrequency$,
PRINT "Step width:       "; stepwidth$
REM *****
```

## 6. List Management

```

REM ----- Example of list management -----CALL
IBWRT(generator%, "SYST:MSEQ:SELECT "+CHR$(34)+"MSEQ1"+CHR$(34))
                                'Select list "MSEQ1", is generated if necessary
CALL IBWRT(generator%, "SYST:MSEQ: 1,3,7,2,5,7,7)           'Fill RCL list with values
CALL IBWRT(generator%, "SYST:MSEQ:DWELL 0.2")              '200ms per step
CALL IBWRT(generator%, "TRIGGER:MSEQ:SOURCE AUTO")         'Permanently repeat MSEQ automatically
CALL IBWRT(generator%, "SYST:MODE MSEQ")                  'Switch over instrument to MSEQ mode
REM *****

```

## 7. Command synchronization

The possibilities for synchronization implemented in the following example are described in Section Command Order and Command Synchronization.

```

REM ----- Examples of command synchronization -----
REM Command ROSCILLATOR:SOURCE INT has a relatively long execution time
REM (over 300ms). It is to be ensured that the next command is only executed
REM when the reference oscillator has settled.

REM First possibility: Use of *WAI -----
CALL IBWRT(generator%, "ROSCILLATOR:SOURCE INT; *WAI; :FREQUENCY 100MHZ")

REM Second possibility: Use of *OPC? -----
OpcOk$ = SPACE$(2)           'Space for *OPC? - Provide response
CALL IBWRT(generator%, "ROSCILLATOR:SOURCE INT; *OPC?")
REM ----- here the controller can service other instruments -----
CALL IBRD(generator%, OpcOk$)           'Wait for "1" from *OPC?

REM Third possibility: Use of *OPC
REM In order to be able to use the service request function in conjugation with a National
REM Instruments GPIB driver, the setting "Disable Auto Serial Poll" must be changed to "yes"
REM by means of IBCONF.
CALL IBWRT(generator%, "*SRE 32")           'Permit service request for ESR
CALL IBWRT(generator%, "*ESE 1")           'Set event-enable bit for operation-complete bit
ON PEN GOSUB OpcReady                       'Initialization of the service request routine
PEN ON
CALL IBWRT(generator%, "ROSCILLATOR:SOURCE INT; *OPC")
REM Continue main program here
STOP                                         'End of program

OpcReady:
REM As soon as the reference oscillator has settled, this subroutine is activated
REM Program suitable reaction to the OPC service request.
ON PEN GOSUB OpcReady                       'Enable SRQ routine again
RETURN
REM *****

```



## 8. Service Request

The service request routine requires an extended initialization of the instrument in which the respective bits of the transition and enable registers are set.

In order to be able to use the service request function in conjunction with a National Instruments GPIB driver, the setting "Disable Auto Serial Poll" must be changed to "yes" by means of IBCONF.

```

REM ----- Example of initialization of the SRQ in the case of errors -----
CALL IBWRT(generator%, "*CLS")           'Reset status reporting system
CALL IBWRT(generator%, "*SRE 168")      'Permit service request for STAT:OPER-,
                                        'STAT:QUES- and ESR register
CALL IBWRT(generator%, "*ESE 60")      'Set event-enable bit for command, execution,
                                        'device-dependent and query error
CALL IBWRT(generator%, "STAT:OPER:ENAB 32767") 'Set OPERATION enable bit for all events
CALL IBWRT(generator%, "STAT:OPER:PTR 32767") 'Set appropriate OPERATION Ptransition bits
CALL IBWRT(generator%, "STAT:OPER:ENAB 32767") 'Set questionable enable bits for all events
CALL IBWRT(generator%, "STAT:OPER:PTR 32767") 'Set appropriate questionable Ptransition bits
ON PEN GOSUB Srq                        'Initialization of the service request routine
PEN ON
REM Continue main program here
STOP                                    'End of program

```

A service request is then processed in the service request routine.

**Note:** The variables *userN%* and *userM%* must be pre-assigned usefully.

```

Srq:
REM ----- Service request routine -----
DO
SRQFOUND% = 0
FOR I% = userN% TO userM%               'Poll all bus users
ON ERROR GOTO nouser                    'No user existing
CALL IBRSP(I%, STB%)                   'Serial poll, read status byte
IF STB% > 0 THE                          'This instrument has bits set in the STB
SRQFOUND% = 1
IF (STB% AND 16) > 0 THEN GOSUB Outputqueue
IF (STB% AND 4) > 0 THEN GOSUB Failure
IF (STB% AND 8) > 0 THEN GOSUB Questionablestatus
IF (STB% AND 128) > 0 THEN GOSUB Operationstatus
IF (STB% AND 32) > 0 THEN GOSUB Esrread
END IF
nouser:
NEXT I%
LOOP UNTIL SRQFOUND% = 0
ON ERROR GOTO error handling
ON PEN GOSUB Srq: RETURN                 'Enable SRQ routine again;
'End of SRQ routine

```

Reading out the status event registers, the output buffer and the error/event queue is effected in subroutines.

```

REM ----- Subroutines for the individual STB bits -----
Outputqueue:
Message$ = SPACE$(100)           'Reading the output buffer
                                  'Make space for response
CALL IBRD(generator%, Message$)
PRINT "Message in output buffer :"; Message$
RETURN

Failure:
ERROR$ = SPACE$(100)             'Read error queue
                                  'Make space for error variable
CALL IBWRT(generator%, "SYSTEM:ERROR?")
CALL IBRD(generator%, ERROR$)
PRINT "Error text :"; ERROR$
RETURN

Questionablestatus:
Ques$ = SPACE$(20)               'Read questionable status register
                                  'Preallocate blanks to text variable
CALL IBWRT(generator%, "STAtus:QUEStionable:EVENT?")
CALL IBRD(generator%, Ques$)
IF (VAL(Ques$) AND 128) > 0 THEN PRINT "Calibration ?" 'Calibration is questionable
IF (VAL(Ques$) AND 1) > 0 THEN PRINT "Voltage ?"      'Output level is questionable
RETURN

Operationstatus:
Oper$ = SPACE$(20)               'Read operation status register
                                  'Preallocate blanks to text variable
CALL IBWRT(generator%, "STAtus:OPERation:EVENT?")
CALL IBRD(generator%, Oper$)
IF (VAL(Oper$) AND 1) > 0 THEN PRINT "Calibration"
IF (VAL(Oper$) AND 2) > 0 THEN PRINT "Settling"
IF (VAL(Oper$) AND 8) > 0 THEN PRINT "Sweeping"
IF (VAL(Oper$) AND 32) > 0 THEN PRINT "Wait for trigger"
RETURN

Esrread:
Esr$ = SPACE$(20)               'Read event status register
                                  'Preallocate blanks to text variable
CALL IBWRT(generator%, "*ESR?") 'Read ESR
CALL IBRD(generator%, Esr$)
IF (VAL(Esr$) AND 1) > 0 THEN PRINT "Operation complete"
IF (VAL(Esr$) AND 4) > 0 THEN GOTO Failure
IF (VAL(Esr$) AND 8) > 0 THEN PRINT "Device dependent error"
IF (VAL(Esr$) AND 16) > 0 THEN GOTO Failure
IF (VAL(Esr$) AND 32) > 0 THEN GOTO Failure
IF (VAL(Esr$) AND 64) > 0 THEN PRINT "User request"
IF (VAL(Esr$) AND 128) > 0 THEN PRINT "Power on"
RETURN
REM *****

REM ----- Error routine -----
Error handling:
PRINT "ERROR"                    'Output error message
STOP                              'Stop software

```



# Index

## #

$\pi/4$ DQPSK modulation ..... 2.88

## A

A field (DECT) ..... 2.332, 3.59  
 Abort actions triggered ..... 3.17  
 Active edge (external trigger) ..... 2.114, 2.429, 3.77, 3.214  
 Additional ..... 3.180  
   mobile station ..... 3.192  
 Additional MS (Enhanced Channels) ..... 2.260  
 Address  
   IEC/IEEE bus ..... 2.410, 3.202  
 Addressed commands ..... A.3  
 ALC TABLE- calibration ..... 2.421, 3.144  
 AM/AM conversion ..... 2.387  
 AM/PM conversion ..... 2.387  
 Amplitude marker (RF sweep) ..... 2.397  
 Amplitude marker (RF-sweep) ..... 3.112  
 Amplitude modulation ..... 2.59, 3.50  
   frequency ..... 2.59, 3.50  
   test procedure ..... 5.31  
 ANTENNA DIVERSITY (3GPP W-CDMA) ..... 2.196, 3.170  
 ARB ..... 2.341, 3.18  
   AMIQ compatible commands ..... 3.29  
   Interpolation rate ..... 2.343  
   Use of WinIQSIM ..... 2.344  
   Waveform format ..... 3.23  
 ARB waveform  
   Automatic SMIQ settings ..... 2.352, 3.21  
   converting ..... 3.29  
   Creating manually ..... 3.25  
   Data ..... 3.19  
   Delete ..... 2.352, 3.19  
   IQ level ..... 2.355, 3.22  
   Select ..... 2.349, 3.19  
 Arbitrary Waveform Generator ..... 2.341, 3.18  
   test procedure ..... 5.77  
 Area constant (fading simulation) ..... 2.77, 3.88  
 ASCII character (#) ..... 3.11  
 Asterix ..... 3.11  
 Attenuator ..... 2.48  
 Attenuator circuits  
   indication ..... 2.427  
 ATTENUATOR MODE FIXED ..... 5.17  
 AWGN signal ..... 2.383

## B

B field (DECT) ..... 2.332, 3.60  
 Base station  
   CDMA ..... 2.130  
   configuration (3GPP W-CDMA) ..... 2.193  
   DECT ..... 2.318  
   Enhanced ..... 3.183  
   GSM/EDGE ..... 2.301  
   NADC ..... 2.262  
   name (3GPP W-CDMA) ..... 2.194  
   OCNS ..... 3.187  
   PDC ..... 2.279

PHS ..... 2.115  
 W-CDMA ..... 2.150  
 Baseband filter  
   3GPP W-CDMA ..... 2.182, 3.165  
   GSM/EDGE ..... 3.97  
   W-CDMA ..... 2.157, 3.154  
 Battery test  
   data generator ..... 4.2  
   RAM ..... 4.2  
   Test procedure ..... 5.41  
 Baud rate  
   RS232 ..... 2.411, 3.202, A.5  
   SERDATA ..... 2.412, 3.202  
 BB-AM ..... 2.60, 3.50  
 BB-AM output ..... 2.7  
 Beeper ..... 2.430, 3.202  
 BER (connector) ..... 1.15  
 BER interface ..... 2.19  
 BIRTH-DEATH  
   Dwell period ..... 2.84, 3.92  
 Bit clock  
   DECT ..... 2.326, 3.56  
   digital modulation ..... 2.111, 3.76  
   NADC ..... 2.270, 3.118  
   PDC ..... 2.287, 3.127  
   PHS ..... 2.123, 3.137  
 BIT CLOCK input/output ..... 2.7, 2.95, 3.77  
 Bit error (Enhanced Channels) ..... 3.184, 3.185, 3.190  
 Bit error rate test  
   continuous measurement ..... 3.30  
   single measurement ..... 3.30  
 Bit error rate test BERT ..... 2.366, 2.368, 3.30  
   Break ..... 2.375  
   Continuous measurement ..... 2.370  
   Cyclic random sequences ..... 2.374  
   Cyclic restart ..... 2.375  
   Data interruption ..... 2.374  
   DECT ..... 2.319  
   Integrating ..... 2.375  
   Interrupted random sequence ..... 2.375  
   Memory wrap-around ..... 2.375  
   mode ..... 2.370, 3.30  
   problems and solutions ..... 2.377  
   Single measurement ..... 2.370  
   statistics ..... 2.376  
   synchronization ..... 2.377  
   termination criteria ..... 2.376  
   test procedure ..... 5.63  
   value range ..... 2.376  
 Bit error rates ..... 2.230  
 Bit errors (Enhanced Channels) ..... 2.244  
 BITCLK output ..... 2.15  
 BLANK output ..... 2.21, 2.394, 2.402, 2.429  
 Blank time ..... 2.429, 3.149  
 Block data ..... 3.44  
 Block error rate measurement BERT  
   continuous measurement ..... 2.379  
   operating mode ..... 2.379  
   termination criteria ..... 2.381  
 Block error rate measurement BLER ..... 3.34  
   continuous measurement ..... 3.34  
   single measurement ..... 2.379, 3.34  
   statistics ..... 2.380  
   synchronization ..... 2.382

- value range ..... 2.380
  - Boolean parameter ..... 3.9
  - Brief instructions ..... 3.1
  - Brightness
    - control (oscilloscope) ..... 2.395
    - display ..... 1.2, 2.11
  - Broadband amplitude modulation (BB-AM) ..... 2.60, 3.50
  - test procedure ..... 5.33
  - Broadband FM
    - test assembly ..... 5.3
  - Burst
    - Normal Burst (GSM/EDGE) ..... 2.316
  - BURST GATE input/output ..... 2.15
  - Burst gate signal (digital modulation) ..... 2.93, 2.112, 3.71
  - Burst type
    - GSM/EDGE ..... 2.316
  - BxT rate (digital modulation) ..... 2.107, 3.75
- C**
- Calibration
    - ALC TABLE ..... 2.421, 3.144
    - disable ..... 3.205
    - FADING SIM ..... 3.37
    - LEV ATT ..... 2.422, 2.423, 3.37
    - LEV PRESET ..... 2.420, 3.38
    - LEVEL ..... 2.417, 3.38
    - password ..... 2.417, 3.205
    - REF OSC ..... 2.417, 3.38
    - VCO SUM ..... 2.418, 3.39
    - VECTOR MOD ..... 2.419, 3.39
  - Cancellation ..... 2.228, 2.232
  - CARRIER/NOISE RATIO ..... 2.384, 5.75
  - Caution messages ..... 2.433
  - CCDF (3GPP W-CDMA) ..... 2.191
  - CCDF (ARB) ..... 2.343
  - CDMA ..... 2.130, 3.102
  - CDVCC (NADC) ..... 2.275
  - Cell station (CS)
    - DECT ..... 2.318
    - GSM/EDGE ..... 2.301
    - NADC ..... 2.262
    - PDC ..... 2.279
    - PHS ..... 2.115
  - Center frequency (RF sweep) ..... 2.396, 3.80
  - Channel (CDMA) ..... 2.145, 3.107
  - Channel coding
    - enhanced channels ..... 2.243
    - Enhanced Channels ..... 3.183
    - mobile station ..... 3.189
  - Channel configuration
    - base station (3GPP W-CDMA) ..... 2.193
    - delete (3GPP W-CDMA) ..... 2.180, 3.164
    - load (3GPP W-CDMA) ..... 2.180, 3.163
    - mobile station (3GPP W-CDMA) ..... 2.199
    - Several DPCHs (3GPP W-CDMA) ..... 2.208
    - store (3GPP W-CDMA) ..... 2.180, 3.163
  - Channel graph (3GPP W-CDMA) ..... 2.210
  - Channel parameters (3GPP W-CDMA) ..... 2.210
  - Channel simulation (3GPP W-CDMA) ..... 2.209, 3.171
  - Channel table DPDCH ..... 2.207
  - Channel types
    - 3GPP W-CDMA ..... 2.170
  - Channel-coded P-CCPCH ..... 2.236, 2.242
  - Channelization code (3GPP W-CDMA) ..... 2.197, 2.211, 3.172
  - step width ..... 2.209
  - Channelization code (enhanced channels) ..... 2.251
  - Channelization code (Enhanced Channels) ..... 3.185
  - Channelization code generator ..... 2.174
  - Character data ..... 3.8
  - Characteristics
    - distortion ..... 2.387
  - Check
    - rated characteristics ..... 5.1
  - Checksum
    - control list ..... 3.41, 4.2
    - data list ..... 3.40, 4.2
  - Chip clock
    - 3GPP W-CDMA ..... 2.183, 2.187, 3.168
    - CDMA ..... 2.143, 3.106
    - W-CDMA ..... 2.160, 3.156
  - Chip rate
    - 3GPP W-CDMA ..... 2.182, 2.338
    - CDMA ..... 2.138, 3.103
    - W-CDMA ..... 2.157, 3.154
  - CI - Channel Identifier-data field (PHS) ..... 2.128
  - Cleaning the outside ..... 4.1
  - Clipping (3GPP WCDMA) ..... 2.182, 3.165
  - CLIPPING LEVEL (3GPP W-CDMA)
    - Effect on signal ..... 2.213
  - Clock recovery (BLER) ..... 2.382
  - Clock source
    - 3GPP W-CDMA ..... 2.187, 3.168
    - ARB ..... 2.354, 3.22
    - CDMA ..... 2.143, 3.106
    - DECT ..... 2.326, 3.56
    - digital modulation ..... 2.111, 3.75
    - GSM/EDGE ..... 2.308, 3.98
    - NADC ..... 2.269, 3.118
    - PDC ..... 2.286, 3.127
    - PHS ..... 2.123, 3.137
    - W-CDMA ..... 2.160, 3.156
  - CMOS-RAM ..... 1.2
  - Code domain
    - Conflict** ..... 2.212
    - Display ..... 2.212
  - Code tree of channelization codes ..... 2.211
  - Coding (digital modulation) ..... 2.87, 2.104, 2.108, 3.75
  - Colon ..... 3.11
  - Color code data field (PDC) ..... 2.293, 2.300
  - Combination of modulation methods ..... 2.91
  - Comma ..... 3.11
  - Command
    - addressed ..... A.3
    - line structure ..... 3.8
    - list ..... C.1
    - parameter ..... 3.9
    - recognition ..... 3.216
    - sequence ..... 3.217
    - structure ..... 3.6
    - synchronization ..... 3.217
    - syntax elements ..... 3.11
    - universal ..... A.3
  - Commands
    - AMIQ compatible commands ..... 3.29
  - Common commands** ..... 3.5, 3.14
  - Complementary cumulative distribution function (3GPP W-CDMA) ..... 2.191
  - Condition register** ..... 3.219
  - Constellation (3GPP W-CDMA) ..... 2.192
  - Constellation of previous perch channel ..... 2.221
  - Contrast (display) ..... 1.2, 2.11
  - Control list (digital modulation) ..... 2.93, 2.103, 3.71
  - checksum ..... 3.40
  - Conversion
    - AM/AM ..... 2.387
    - interpolation points ..... 2.387
    - AM/PM ..... 2.387
    - Interpolation points ..... 2.387
  - Copy data of a base/mobile station (3GPP W-CDMA) 2.184, 3.167
  - Correlation (fading simulation) ..... 3.88

- Counter..... 2.427, 3.42
- Coupled parameters ..... 2.74, 3.86
- Coupling
  - EXT1 (AM) ..... 2.59, 3.50
  - EXT1/2
    - FM..... 2.61, 3.78
    - PM ..... 2.63, 3.142
- CRC
  - Polynomial..... 2.380
- CRC (Cyclic Redundancy Code)..... 2.333
- Crest factor..... 2.230
- 3GPP W-CDMA..... 2.189, 3.166
  - enhanced Channels..... 2.257
  - Enhanced Channels ..... 3.188
- Crosstalk ..... 2.233
- CS-ID - Cell Station ID (PHS) ..... 2.128, 3.140
- CW input/output..... 2.15
- CW signal (digital modulation) ..... 2.93
  
- D**
- Data
  - bits (RS232) ..... 2.411, A.5
  - input/output ..... 2.7, 2.13, 2.96
  - lines (IEC/IEEE-bus) ..... A.1
  - offset ..... 3.158
  - rate (CDMA) ..... 2.145, 3.108
- Data enable input..... 2.375
- Data generator
  - installation ..... 1.7
  - test procedure ..... 5.41
- Data list ..... 2.129, 2.147, 2.275, 2.294, 2.313, 2.333, 3.69
  - checksum ..... 3.41, 4.2
  - enhanced channels ..... 2.252
  - GSM/EDGE ..... 2.317
- Data source ..... 2.174
  - data field..... 2.251, 3.186
  - DCCH field ..... 3.192
  - DCCH field ..... 3.186
  - DTCH field..... 3.186
  - DTCH field..... 3.192
  - TPC field ..... 2.252, 3.187
- DC voltage offset
  - test procedure ..... 5.78
- DCL ..... 3.215
- Decimal point..... 2.3, 3.9
- DECT..... 2.318, 3.53
  - test procedure ..... 5.47
- Default setting
  - 3GPP W-CDMA..... 2.335, 2.336
- Default setting (3GPP W-CDMA)..... 2.180, 3.163
- Default setting (CDMA)..... 2.138, 3.103
- Default setting (W-CDMA) ..... 2.156, 3.153
- Default values (3GPP W-CDMA) ..... 2.216
- Delay
  - clock
    - 3GPP W-CDMA..... 2.187, 3.168
    - ARB ..... 2.354, 3.22
    - CDMA ..... 2.143, 3.106
    - DECT ..... 2.326, 3.56
    - digital modulation ..... 2.111, 3.76
    - GSM/EDGE..... 2.309, 3.99
    - NADC..... 2.270, 3.118
    - PDC ..... 2.287, 3.127
    - PHS ..... 2.123, 3.137
  - signal
    - 3GPP W-CDMA ..... 2.186, 2.337, 3.168
    - ARB ..... 2.347, 3.20
    - DECT ..... 2.325, 3.56
    - GSM/EDGE..... 2.308, 3.98
    - NADC ..... 2.269, 3.118
    - PDC ..... 2.286, 3.127
    - PHS ..... 2.122, 3.136
- Delay range
  - Fading simulation..... 2.84
- Delete
  - all data stored ..... 2.413, 3.205
  - frame (DECT)..... 2.329, 3.58
  - frame (GSM/EDGE) ..... 2.311, 3.100
  - frame (NADC) ..... 2.272, 3.120
  - frame (PDC)..... 2.289, 3.129
  - frame (PHS)..... 2.125, 3.139
  - list ..... 2.33
  - list entry ..... 2.39
  - mapping (CDMA) ..... 2.145, 3.107
  - memory..... 2.413, 3.205
- Delimiter..... 3.215
- Delta phase ..... 2.415, 3.133
- Demultiplexer ..... 2.176
- Detuning, external..... 2.414
- Deviation
  - FM ..... 2.61, 3.78
  - FSK (digital modulation)..... 2.106, 3.75
  - PM ..... 2.63, 3.142
- Deviation error
  - FSK..... 5.39
  - GFSK..... 5.40
- Deviation limits
  - FM ..... 2.62
  - PM ..... 2.64
- Differential coding (digital modulation)..... 2.104, 3.75
- Digit cursor..... 2.23
- Digital modulation..... 2.86, 3.65
  - coding ..... 2.87, 3.75
  - constellation diagram ..... 2.87
  - control list..... 2.103, 3.71
  - data list 2.103, 2.129, 2.147, 2.275, 2.294, 2.313, 2.333, 3.69
  - envelope control..... 2.99, 2.112
  - FSK..... 2.89
  - menu..... 2.101
  - modulation data ..... 2.92, 2.102, 3.69
  - modulation methods ..... 2.87
  - PRBS data ..... 2.94
  - PSK ..... 2.87
  - QAM ..... 2.87
  - setting conflicts ..... 2.91
  - test procedure ..... 5.38
  - trigger..... 2.109, 3.77
- Digital standard
  - 3GPP W-CDMA ..... 2.169, 3.159
  - DECT ..... 2.318, 3.53
  - GSM/EDGE ..... 2.301, 3.96
  - IS-95 CDMA..... 2.130, 3.102
  - NADC..... 2.262, 3.115
  - PDC ..... 2.279, 3.124
  - PHS ..... 2.115, 3.134
  - test procedure..... 5.45
  - W-CDMA..... 2.150, 3.152
- Digital synthesis (slot) ..... 1.5
- Disabling keyboard..... 3.203

- Display
  - brightness..... 2.11
  - contrast..... 2.11
  - test procedure..... 5.8
- Distortion characteristics..... 2.387
  - calculation from polynomial equations..... 2.390
  - enter a new distortion characteristic..... 2.389
  - loading new distortion characteristics..... 2.387
  - selection..... 2.385
- Distortion simulation
  - test procedure..... 5.70
- Distortion simulator..... 2.383
  - level correction..... 2.388
- Domain conflict..... 2.212**
- Doppler shift
  - Fading simulation..... 2.76, 2.80, 2.84, 3.87, 3.89, 3.92
- Downlink
  - DECT..... 2.318
  - GSM/EDGE..... 2.301
  - NADC..... 2.262
  - PDC..... 2.279
  - PHS..... 2.115
- Downlink signal
  - 3 GPPW-CDMA..... 2.182, 3.165
- DPCCH POWER..... 2.256
- DPDCH POWER..... 2.255
- DUMMY Burst (GSM/EDGE)..... 2.314
- Duration blank signal..... 2.429, 3.197
- Dwell list
  - LIST..... 2.404
  - MSEQ..... 2.406, 3.204
- Dwell time
  - level sweep..... 2.398, 3.150
  - LF sweep..... 2.400, 3.197
  - LIST..... 2.404, 3.110
  - MSEQ..... 2.409, 3.204
  - RF sweep..... 2.397, 3.149
- E**
- ECL output..... 2.114
- Edge (external trigger)..... 2.114, 2.429, 3.77, 3.214
- Edit list..... 2.35
- EMF..... 2.53
- Enable register..... 3.219
- Encryption scrambling (PHS)..... 2.127, 3.140
- Enhanced channels
  - bit error..... 3.185, 3.190
  - bit errors..... 2.244
  - channel coding..... 2.243
  - channel start power..... 2.251
  - channelization code..... 2.251
  - data source..... 2.251, 2.252, 3.186, 3.192
  - external power control mechanism..... 2.254
  - multicode..... 2.252
  - symbol rate..... 2.256
- Enhanced Channels..... 2.236, 3.180
  - Additional MS..... 2.260
  - Base station..... 3.183
  - bit error..... 3.184
  - Branching with 3GPP W-CDMA..... 2.237
  - channel coding..... 3.183
  - channel start power..... 3.185
  - channelization code..... 3.185
  - crest factor..... 2.257, 3.188
  - data field..... 3.187
  - data source..... 3.186
  - External power control..... 2.256
  - external power control mechanism..... 2.246, 3.183, 3.189
  - Maximum input level..... 2.259
  - mobile station..... 3.188
  - Multicode..... 3.187
  - OCNS channels..... 3.187
  - Overall symbol rate in uplink..... 2.255
  - overall symbol rate uplink..... 3.190
  - sequence length..... 3.184
  - Sequence length..... 2.248
  - symbol rate..... 2.248, 3.184
  - test procedure..... 5.62
  - timing offset..... 2.249, 3.184
- Enhanced P-CCHCP/BCH State..... 2.241
- Envelope control
  - DECT..... 2.327, 3.56
  - digital modulation..... 2.99, 2.112, 3.76
  - GSM/EDGE..... 2.309, 3.99
  - NADC..... 2.270, 3.118
  - PDC..... 2.287, 3.128
  - PHS..... 2.124, 3.137
- Envelopes (3GPP W-CDMA)..... 2.224**
- EOI (command line)..... 3.8
- EPROM, test..... 4.2
- Equalizer (CDMA)..... 2.138
- Error messages..... 2.433, 3.206, B.1
- Error queue..... 3.200, 3.203, 3.226
- Error rate measurement BLER
  - operating mode..... 3.34
- Error vector
  - noise generation and distortion simulation..... 5.75
  - PSK..... 5.40
  - QAM..... 5.40
  - test procedure..... 5.27
- Error vector magnitude
  - measure..... 5.27
- ESE (event status enable register)..... 3.222
- Event status enable register (ESE)..... 3.222
- Exponent..... 3.9
- EXT TUNE input..... 2.21, 2.414
- EXT1/2
  - coupling..... 2.59, 2.61, 2.63, 3.50, 3.78, 3.142
  - input..... 2.21
- External detuning..... 2.414
- External modulation sources..... 2.55**
- External power control
  - Enhanced Channels..... 2.256
- External power control mechanism..... 2.246, 2.254, 3.183, 3.189
- External reference..... 2.414, 3.148
- External trigger
  - active edge..... 2.114, 2.429, 3.77, 3.214
  - LIST..... 2.402, 3.212
  - MSEQ..... 2.407, 3.214
  - sweep..... 2.394, 3.210
- F**
- Fading simulation..... 2.70, 3.82
  - Area constant..... 2.77, 3.88
  - BIRTH-DEATH..... 2.83
  - Configuration..... 2.72, 2.73, 3.84
  - Correlation..... 2.77, 3.88
  - Correlation between paths..... 2.72
  - Correlation coefficient..... 2.77, 3.88
  - Coupled parameters..... 2.74, 3.86
  - Delay range..... 2.84
  - Doppler shift..... 2.76, 2.80, 2.84, 3.87, 3.89, 3.92
  - Dwell period..... 2.84, 3.92
  - Fine Delay..... 2.78
  - Insertion loss..... 2.74, 2.84, 3.86, 3.91
  - Log Normal fading..... 2.77, 3.88
  - Moving Delay..... 2.81
  - Output power..... 2.71

- Profile.....2.75, 2.80, 2.84, 3.87, 3.89, 3.92
  - Pseudo Noise Generator.....2.73, 3.84
  - Rayleigh fading.....2.75, 2.80, 3.87, 3.89
  - Ricean fading.....2.75, 3.87
  - Signal delay.....2.76, 2.80, 2.82, 2.84, 3.88, 3.90, 3.92
  - Standard Fading.....2.73
  - test assembly.....5.6
  - test procedure.....5.64
  - Time grid.....2.84
  - Two-channel fading.....2.71
  - Variation period.....2.82, 3.91
  - Fading simulator
    - calibration.....3.37
    - installation.....1.8
    - slot.....1.5
    - test.....4.2
  - FBI (3GPP W-CDMA).....2.175, 2.204, 2.206
  - Filter
    - 3GPP W-CDMA.....2.182, 2.183, 2.339, 3.165, 3.166
    - CDMA.....2.138, 3.104
    - DECT.....2.323, 3.55
    - digital modulation.....2.107, 3.75
    - GSM/EDGE.....2.306, 3.97, 3.98
    - NADC.....2.267, 3.116
    - PDC.....2.284, 3.126
    - PHS.....2.120, 3.135
    - W-CDMA.....2.157, 3.154
  - Filtering.....2.177
  - Fitting options.....1.4
  - FM
    - coupling.....2.61, 3.78
    - deviation.....2.61, 3.78
    - deviation limits.....2.62
    - frequency.....2.61, 3.79
    - modulator.....1.6
    - slot.....1.5
    - preemphasis.....2.61, 2.62, 3.79
  - Format, data (IEC/IEEE bus).....3.44
  - Forward link signal (CDMA).....2.136, 3.103
  - Frame
    - DECT.....2.328, 3.57
    - GSM/EDGE.....2.310, 3.100
    - NADC.....2.272, 3.120
    - PDC.....2.288, 3.129
    - PHS.....2.125, 3.138
  - Frequency**
    - accuracy.....1.2**
    - AM.....2.59, 3.50
    - FM.....2.61, 3.79
    - indication.....2.22
    - suppression.....2.413, 3.43
    - LF generator.....2.391, 3.194
    - LF sweep.....2.399, 3.195
    - list (LIST).....2.401, 3.111
    - offset.....2.45, 3.81
    - PM.....2.63, 3.143
    - RF output signal.....3.80
    - RF sweep.....2.396, 3.81
    - test procedure.....5.8
  - Frequency marker
    - LF sweep.....2.400, 3.196
    - RF sweep.....2.397, 3.112
  - Frequency modulation (FM).....2.61, 3.78
  - test procedure.....5.34
  - Frequency range (3GPP W-CDMA).....2.225
  - Frequency sweep
    - LF.....2.399, 3.197
    - RF.....2.396, 3.149
  - FSK modulation (digital modulation).....2.89
  - Full rate (CDMA).....2.146, 3.108
  - Functional test.....4.1
- G**
- GET (Group Execute Trigger).....3.216
  - GPS.....3.93
  - GSM/EDGE.....2.301, 3.96
  - test procedure.....5.46
  - Guard data field
    - DECT.....2.333
    - GSM/EDGE.....2.314
    - NADC.....2.274
    - PDC.....2.295, 2.297, 2.299
    - PHS.....2.129
- H**
- Half rate (CDMA).....2.146, 3.108
  - Handshake (RS232).....2.411, 3.202, A.6
  - Header (commands).....3.6
  - Header field (display).....2.22**
  - HOP mode(LIST).....2.402, 3.213
  - HOP output.....2.15
  - HOP trigger signal (GSM/EDGE).....2.312, 3.101
  - Hopping.....2.316
  - Hopping signal (digital modulation).....2.93
- I**
- I FADED output.....2.13
  - I/Q
    - constellation diagram.....2.87
    - filter.....2.68
    - modulation.....2.66, 2.356, 3.65
  - I/Q imbalance
    - test procedure.....5.29
  - I/Q modulator
    - calibration.....2.419, 3.39
  - Idle data field (PHS).....2.129
  - IEC/IEEE bus
    - address.....2.410, 3.202
    - interface.....2.19, A.1
    - language.....2.414
  - Imbalance.....2.67, 3.66
  - Impairment.....2.67, 2.69, 3.65
  - Indentations.....3.12**
  - Indication
    - attenuator circuits.....2.427
    - counter.....2.427
    - error messages.....2.433, 3.200
    - modules.....2.424, 3.41
    - operating hours.....3.42
    - operating-hours.....2.427
    - serial number.....2.427, 3.15
    - software version.....2.427, 3.42
    - suppress.....2.413
  - Inhibition of retrigger
    - 3GPP W-CDMA.....2.185, 3.167
    - ARB.....2.347, 3.20
    - CDMA.....2.141, 3.105
    - DECT.....2.325, 3.56
    - digital modulation.....2.110, 3.77
    - GSM/EDGE.....2.307, 3.98
    - NADC.....2.269, 3.117
    - PDC.....2.286, 3.127
    - PHS.....2.122, 3.136
    - W-CDMA.....2.159, 3.155
  - Inhibition trigger
    - 3GPP W-CDMA.....2.337
  - Initial status.....1.2
  - Input.....2.15



- BIT CLOCK ..... 2.7, 2.95
  - buffer ..... 3.215
  - correction ..... 2.27
  - CW ..... 2.15
  - data ..... 2.13
  - DATA ..... 2.7, 2.96
  - Data enable ..... 2.375
  - DATA-Dx ..... 2.97
  - EXT TUNE ..... 2.21, 2.414
  - EXT1/2 ..... 2.21
  - LEV-ATT ..... 2.15
  - POW RAMP ..... 2.17, 2.99
  - PULS ..... 2.21
  - REF ..... 2.19
  - RES ..... 2.375
  - resistance ..... 2.19, 2.21
  - SER DATA ..... 2.17, 2.98
  - SYMBCLK ..... 2.13, 2.97
  - SYMBOL CLOCK ..... 2.7, 2.95
  - TRIGGER ..... 2.21, 2.394, 2.402, 2.407, 2.429, 3.214
  - TRIGIN ..... 2.15
  - Inputs for modulations ..... 2.55
  - Insert list entry ..... 2.38
  - Installation
    - options ..... 1.4
    - software options** ..... **1.15**, 2.431
  - Instrument reset ..... 1.3, 3.16, 3.205
  - Instrument settings
    - recall ..... 2.43, 3.16
    - save ..... 2.43, 3.16
  - Integrating BER measurement ..... 2.375
  - Interface
    - BER ..... 2.19
    - functions (IEC/IEEE-bus) ..... A.2
    - functions (RS-232-C) ..... A.5
    - IEC/IEEE-bus ..... 2.19
    - messages (IEC/IEEE-bus) ..... A.3
    - PAR DATA ..... 2.97
    - RS232 ..... 2.19
    - SERDATA ..... 2.98, A.7
  - Interleaver function (Enhanced Channels) ..... 3.183
  - Intermodulation suppression ..... 2.50
  - Interpolation rate (ARB) ..... 2.343
  - Interrupt ..... 3.221
  - Interrupt-free level setting ..... 2.50
  - IQ AUX output ..... 2.13
  - IQ Multiplex (W-CDMA) ..... 2.165
  - IS-95 CDMA ..... 2.130, 3.102
    - test procedure ..... 5.51
  - IST flag ..... 3.15
- J**
- Jitter simulation (DECT) ..... 2.328
- K**
- Key
    - / ..... 2.3
    - [ASSIGN] ..... 2.11, **2.25**
    - [BACKSPACE] ..... 2.3
    - [ERROR] ..... 2.9, 2.433
    - [FREQ] ..... 2.3, 2.45
    - [G/n] ..... 2.5
    - [HELP] ..... 2.9, 2.432
    - [k/m] ..... 2.5
    - [LEVEL] ..... 2.3, 2.47
    - [LOCAL] ..... 2.9, 3.3
    - [M/ $\mu$ ] ..... 2.5
    - [MENU 1/2] ..... 2.11, **2.25**
    - [MOD ON/OFF] ..... 2.9, 2.58, 2.428
    - [PRESET] ..... 1.3, 2.9
    - [RCL] ..... 2.3, 2.43
    - [RETURN] ..... 2.5, 2.23
    - [RF ON/OFF] ..... 2.9, **2.26**, 2.54
    - [SAVE] ..... 2.3, 2.43
    - [SELECT] ..... 2.5, 2.23
    - [STATUS] ..... 2.9, 2.432
    - [X1/Enter] ..... 2.5
  - Key words (commands) ..... 3.6
  - Keyboard
    - disabling ..... 3.203
    - test procedure ..... 5.8
- L**
- Leakage ..... 2.67, 3.66
  - LEARN (LIST mode) ..... 2.404, 3.111
  - LEV ATT
    - calibration ..... 2.422, 2.423, 3.37
    - input/output ..... 2.15
  - Level
    - attenuation
      - DECT ..... 2.328, 3.57
      - digital modulation ..... 2.93, 2.112, 3.77
      - GSM/EDGE ..... 2.310, 3.99
      - NADC ..... 2.271, 3.119
      - PDC ..... 2.288, 3.128
      - PHS ..... 2.125, 3.138
    - calibration ..... 3.38
    - control ..... 2.50, 3.144
    - control of burst
      - DECT ..... 2.327, 3.56
      - digital modulation ..... 2.112, 3.76
      - GSM/EDGE ..... 2.309, 3.99
      - NADC ..... 2.270, 3.118
      - PDC ..... 2.287, 3.128
      - PHS ..... 2.124, 3.137
    - correction
      - list UCOR ..... 2.52, 3.51
    - indication ..... 2.22
    - resolution ..... 2.48
    - suppression ..... 2.413, 3.43
    - limit ..... 2.48, 3.145
    - list ..... 2.401, 3.111
    - marker ..... 2.399, 3.113
    - offset ..... 2.48, 3.145
    - presetting (calibration) ..... 3.38
    - RF output ..... 2.47, 3.145
    - sweep ..... 2.398, 3.146, 3.150
    - test procedure ..... 5.12
    - unit ..... 2.26, 2.47, 3.215
  - Level correction
    - polynomial ..... 2.386
    - Polynomial ..... 3.64
  - Level reduction
    - GSM/EDGE ..... 2.316
  - LF
    - frequency ..... 2.391, 3.194
    - generator ..... 2.57, 2.391, 3.194
    - output ..... 2.21, 2.391, 3.48
    - sweep ..... 2.399, 3.195
  - Link direction
    - 3 GPP W-CDMA ..... 2.182, 3.165
  - List
    - commands ..... C.1
    - control (digital modulation) ..... 2.93, 2.103, 3.71
    - delete ..... 2.34

- dwell (LIST)..... 2.404, 3.110  
 dwell (MSEQ)..... 2.406, 3.204  
 edit..... 2.35  
 fill..... 2.36  
 frequency (LIST)..... 2.401, 3.111  
 function LEARN..... 2.404, 3.111  
 generate..... 2.33  
 instrument states (MSEQ)..... 3.204  
 level (LIST)..... 2.401, 3.111  
 level correction (UCOR)..... 2.52, 3.51  
 manual processing of the list..... 2.402  
 open..... 2.33  
 operating modes (LIST)..... 2.401, 3.110, 3.213  
 operating modes (MSEQ)..... 2.407, 3.204, 3.214  
 select..... 2.33  
 store..... 2.35
- LIST**  
 inputs/outputs..... 2.402  
 operating modes..... 3.111
- List entry**  
 delete..... 2.39  
 insert..... 2.38
- Load**  
 frame (DECT)..... 2.329, 3.58  
 frame (GSM/EDGE)..... 2.311, 3.100  
 frame (NADC)..... 2.272, 3.120  
 frame (PDC)..... 2.289, 3.129  
 frame (PHS)..... 2.125, 3.138  
 mapping (CDMA)..... 2.144, 3.107
- Log Normal fading..... 2.77, 3.88  
 Long form (commands)..... 3.7
- Low-distortion mode**  
 CDMA..... 3.104  
 digital modulation..... 3.76  
 NADC..... 2.267, 3.117  
 PDC..... 2.284, 3.126  
 PHS..... 3.136  
 W-CDMA..... 2.158, 3.155
- Lower-case (commands)..... 3.7
- M**  
 Magnitude spectrum of a W-CDMA signal..... 2.225  
 Maintenance..... 4.1  
 Mapping (CDMA)..... 2.144, 3.106  
 Mapping data list (digital modulation)..... 3.72  
**Marker**  
 level sweep..... 2.399, 3.113  
 LF sweep..... 2.400, 3.196  
 RF sweep..... 2.397, 3.112
- MARKER**  
 output..... 2.21, 2.395, 2.403, 2.429, 3.113, 3.196
- Maximal deviation**  
 FM..... 2.62  
 PM..... 2.64
- Maximum input level (Enhanced Channels)..... 2.259  
 Maximum value (commands)..... 3.9
- Memory**  
 delete..... 2.413, 3.205  
 depth (data generator)..... 2.92  
 extension..... 2.86  
 installation..... 1.7  
 sequence (MSEQ)..... 2.406, 3.203, 3.214
- Memory extension SMIQB12**  
 test procedure..... 5.41
- Menu**  
 ANALOG MOD - AM..... 2.59  
 ANALOG MOD - BB-AM..... 2.60  
 ANALOG MOD - FM..... 2.61  
 ANALOG MOD - PM..... 2.63
- BIRTH-DEATH..... 2.83  
**call**..... 2.25  
 cursor..... 2.23  
 DIGITAL MOD..... 2.101  
 DIGITAL STD - DECT..... 2.322  
 DIGITAL STD - GSM/EDGE..... 2.305  
 DIGITAL STD - IS-95- MODE - FWD\_LINK\_18..... 2.136  
 DIGITAL STD - IS-95- MODE - REV\_LINK..... 2.146  
 DIGITAL STD - IS-95- MODE - REV\_LINK\_CODED..... 2.148  
 DIGITAL STD - NADC..... 2.266  
 DIGITAL STD - PDC..... 2.283  
 DIGITAL STD - PHS..... 2.119  
 DIGITAL STD - WCDMA/3GPP - Downlink..... 2.338  
 DIGITAL STD - WCDMA/3GPP - downlink menu..... 2.179  
 ERROR..... 2.433  
**fields**..... 2.23  
 FINE DELAY..... 2.78  
 FREQUENCY..... 2.45  
**HELP**..... 2.432  
 keys..... 2.5  
 LEVEL - ALC..... 2.51, 2.53  
 LEVEL - EMF..... 2.53  
 LEVEL - LEVEL..... 2.47  
 LEVEL - UCOR..... 2.52  
 LF OUTPUT..... 2.391  
 LIST..... 2.403  
 MEM SEQ..... 2.408  
 MODULATION - PULSE..... 2.65  
 MOVING DELAY..... 2.81  
 NOISE/DIST..... 2.384  
 NOISE/DIST - POLYNOMIAL..... 2.385  
 overview (3GPP W-CDMA)..... 2.178  
 path..... 2.23  
 quick selection..... 2.25  
 STATUS..... 2.432  
**store**..... 2.25  
 summary..... 2.44  
 SWEEP - FREQ..... 2.396  
 SWEEP - LEVEL..... 2.398  
 SWEEP - LF GEN..... 2.399  
 UTILITIES - AUX I/O..... 2.429  
 UTILITIES - BEEPER..... 2.430  
 UTILITIES - CALIB - ALC TABLE..... 2.421  
 UTILITIES - CALIB - ALL..... 2.417  
 UTILITIES - CALIB - LEV ATT..... 2.422  
 UTILITIES - CALIB - LEV PRESET..... 2.420  
 UTILITIES - CALIB - VCO SUM..... 2.418  
 UTILITIES - CALIB - VECTOR MOD..... 2.419  
 UTILITIES - DIAG - C/N MEAS..... 2.426  
 UTILITIES - DIAG - CONFIG..... 2.424  
 UTILITIES - DIAG - PARAM..... 2.427  
 UTILITIES - DIAG - TPOINT..... 2.425  
 UTILITIES - INSTALL..... 2.431  
 UTILITIES - MOD KEY..... 2.428  
 UTILITIES - PHASE..... 2.415  
 UTILITIES - PROTECT..... 2.416  
 UTILITIES - REF OSC..... 2.414  
 UTILITIES - SYSTEM - GPIB..... 2.410  
 UTILITIES - SYSTEM - LANGUAGE..... 2.414  
 UTILITIES - SYSTEM - RS232..... 2.411  
 UTILITIES - SYSTEM - SECURITY..... 2.413  
 UTILITIES - SYSTEM - SERDATA..... 2.412  
 UTILITIES - TEST..... 4.2  
 VECTOR MOD..... 2.67
- Menü**  
 DIGITAL STD - WCDMA/3GPP - Downlink..... 2.335
- Messages**  
 IEC/IEEE-bus..... 3.5  
 RS232..... 3.5
- Minimum value (commands)..... 3.8  
 Misuse (3GPP W-CDMA)..... 2.195, 2.206, 3.169
- Mobile station**

- additional..... 3.192
  - CDMA..... 2.130
  - configuration (3GPP W-CDMA)..... 2.199
  - Enhanced..... 3.188
  - W-CDMA..... 2.150
  - Modulation
    - AM..... 2.59, 3.50
    - analog
      - test assembly..... 5.2
    - BB-AM..... 2.60, 3.50
    - data (digital modulation) ..... 2.92, 2.96, 2.97, 2.102, 3.69
    - asynchronous transmission..... 2.98
    - DECT ..... 2.318, 3.53
    - Delay ..... 2.106
    - digital..... 2.86, 3.67
    - external signal ..... 2.56
    - FM..... 2.61, 3.78
    - GSM/EDGE..... 2.301, 3.96
    - I/Q ..... 2.66, 3.65
    - inputs ..... 2.55
    - IS-95 CDMA ..... 2.130, 3.102
    - methods (digital modulation)..... 2.87
    - NADC..... 2.262, 3.115
    - PDC ..... 2.279, 3.124
    - PHS..... 2.115, 3.134
    - PM..... 2.63, 3.142
    - pulse ..... 2.65, 3.147
    - simultaneous ..... 2.57
    - sources..... 2.55
    - vector ..... 2.66, 3.65
    - W-CDMA..... 2.150
  - Modulation coder
    - installation ..... 1.13
  - Modulation data
    - GSM/EDGE..... 2.317
  - Modulation depth
    - AM..... 2.59, 3.50
    - ASK..... 5.39
    - DECT ..... 3.55
    - PM..... 2.63, 3.142
  - Modulation generator
    - test procedure ..... 5.25
  - Module indication..... 2.424, 3.41
  - MSEQ (Memory Sequence)..... 2.406, 3.203, 3.214
  - Multi Channel (3GPP W-CDMA)..... 2.208
  - Multichannel (3GPP W-CDMA)..... 3.170
  - Multicode..... 2.177
    - 3GPP W-CDMA ..... 3.173
    - Channel simulation (3GPP W-CDMA) ..... 2.209, 3.171
    - enhanced channels ..... 2.252
    - Enhanced Channels ..... 3.187
    - W-CDMA ..... 2.161, 3.156
  - Multiplex
    - Link Direction (W-CDMA) ..... 2.156
  - Multisignal measurements ..... 2.50
- N**
- NADC..... 2.262, 3.115
    - test procedure ..... 5.48
  - Name of sequence (MSEQ)..... 2.34, 3.205
  - NAN..... 3.9
  - New Line (command line)..... 3.8
  - NINF..... 3.9
  - Noise generation
    - test procedure ..... 5.70
  - Noise generator and distortion simulator**..... 2.383
    - installation** ..... 1.12
  - NORM, Normal Burst (GSM/EDGE) ..... 2.312
  - NTRansition register** ..... 3.219
- Numeric
    - input field ..... 2.3
    - suffix ..... 3.7
    - values ..... 2.3, 3.9
  - Nyquist filter
    - 3GPP W-CDMA ..... 2.182, 3.165
    - CDMA..... 2.138, 2.139, 3.104
    - DECT..... 2.323, 3.55
    - NADC..... 2.267, 3.116
    - PDC ..... 2.284, 3.126
    - PHS ..... 2.120, 3.135
    - W-CDMA..... 2.157, 3.154
- O**
- OCNS..... 3.180
    - base station ..... 3.187
    - Measurement..... 2.260
  - OCNS channels ..... 3.187
    - fraction of power ..... 2.258
  - Offset
    - frequency..... 2.46, 3.81
    - level ..... 2.48, 3.145
  - Operating hours ..... 3.42
  - Operating modes
    - LIST..... 2.401, 3.81, 3.111, 3.146, 3.212
    - MSEQ..... 2.407, 3.203, 3.214
    - sweep ..... 2.393, 3.81, 3.146, 3.149, 3.197, 3.210
  - Operating-hours ..... 2.427
  - Option
    - fitting..... 1.4
    - SM-B1 - Reference oscillator OCXO..... 1.5, 2.414
    - SM-B5 - FM/PM modulator..... 1.6, 2.61, 2.63
    - SMIQB11 - Data Generator..... 1.7, 2.92
    - SMIQB12 - Memory Extension..... 2.92
    - SMIQB14 - Fading Simulator ..... 1.8
    - SMIQB15 - Second Fading Simulator ..... 1.10
    - SMIQB17 - Noise generator and distortion simulator**..... 1.12, 2.383
    - SMIQB19 - Rear panel connections for RF and LF .... 1.16
    - SMIQB20 - Modulation Coder ..... 1.13, 2.86
    - SMIQB21 - Bit Error Rate Test..... 1.14, 2.368
    - SMIQB42 - Digital Standard IS-95 CDMA ..... 2.130
    - SMIQB47 - LOW ACP Filter..... 2.68
    - SMIQB48 - Enhanced Channels ..... 2.236
    - SMIQB60 - Arbitrary Waveform Generator..... 2.341
  - Orthogonality..... 2.226, 2.230
  - Output
    - BB-AM ..... 2.7
    - BIT CLOCK..... 2.7
    - BITCLK..... 2.15
    - BLANK..... 2.21, 2.394, 2.402, 2.429
    - buffer ..... 3.217
    - CW..... 2.15
    - data..... 2.13
    - DATA ..... 2.7
    - ECL..... 2.114
    - HOP..... 2.15
    - I FADED..... 2.13
    - IQ AUX ..... 2.13
    - LEV-ATT..... 2.15
    - level RF..... 2.47, 3.144
    - LF ..... 2.21, 2.391, 3.48
    - MARKER ..... 2.21, 2.395, 2.403, 2.429, 3.113, 3.196
    - POW RAMP..... 2.17, 2.99
    - Q..... 2.9
    - Q FADED..... 2.13
    - REF ..... 2.19, 2.414
    - RF..... 2.9, 3.47, 3.80
    - SYMBCLK..... 2.13

- SYMBOL CLOCK.....2.7  
 TRIGOUT.....2.15  
 voltage.....2.391, 3.48  
 X\_AXIS.....2.21, 2.394  
 Output impedance  
 test assembly.....5.5  
 OVEN COLD.....1.2  
 Overall symbol rate  
 enhanced channels in uplink.....2.255  
 Enhanced Channels in uplink.....3.190  
 Overlapping execution.....3.216  
 OVERLOAD.....2.54  
 Overload protection.....2.54, 3.47  
 Overmodulation.....2.57  
 Overview  
 menus.....2.44  
 modulation sources.....2.55  
 slots.....1.5  
 status register.....3.220  
 syntax elements.....3.11
- P**
- Page indicators.....2.196  
 PAR DATA interface.....2.97  
 Para. Predef. (3GPP W-CDMA).....2.189  
 Parallel modulation data.....2.97  
 Parallel poll.....3.226  
 Parallel poll enable register (PPE).....3.222  
 Parameter (commands).....3.9  
 Parity (RS232).....3.202, **A.5**  
 Password.....2.416, 3.205  
 Path (commands).....3.6  
 Pattern setting  
 getting started.....2.27  
 list editor.....2.39  
 P-CCPCH/BCH.....2.238  
 PCPCH (3GPP W-CDMA).....2.204  
 PDC.....2.279, 3.124  
 test procedure.....5.49  
 Performance test report.....5.82  
 Period of output signal  
 DECT.....2.325, 3.56  
 GSM/EDGE.....2.308, 3.98  
 NADC.....2.269, 3.118  
 PDC.....2.286, 3.127  
 PHS.....2.122, 3.137  
 Personal station (PS)  
 DECT.....2.318  
 GSM/EDGE.....2.301  
 NADC.....2.262  
 PDC.....2.279  
 PHS.....2.115  
 Phase (RF output signal).....2.415, 3.133  
 Phase error  
 GMSK.....5.40  
 Phase modulation.....2.63, 3.142  
 test procedure.....5.37  
 Phase noise  
 test assembly.....5.5  
 PHS.....2.115, 3.134  
 test procedure.....5.50  
 Physical quantities.....3.8  
 PM  
 coupling.....2.63, 3.142  
 deviation.....2.63, 3.142  
 deviation limits.....2.64  
 frequency.....2.63, 3.143  
 generator.....2.63, 3.142  
 modulator.....1.6, 3.142  
 slot.....1.5  
 Polarity  
 BLANK signal.....2.429, 3.47  
 marker signal.....2.429, 3.113, 3.196  
 pulse modulation.....2.65, 3.147  
 signal  
 3GPP W-CDMA.....2.186  
 3GPP W-CDMA signal.....2.337  
 GSM.....2.308  
 Trigger  
 ARB.....2.347, 3.20  
 Polynomial  
 coefficient AM-AM.....2.385  
 Coefficient AM-AM.....3.63  
 coefficient AM-PM.....2.385  
 Coefficient AM-PM.....3.64  
 entering the parameters.....2.385  
 equations.....2.390  
 level correction.....2.386  
 Level correction.....3.64  
 PRBS.....2.375  
 POW RAMP input/output.....2.17, 2.99  
 Power  
 channel (CDMA).....2.145, 3.106, 3.107  
 channel (W-CDMA).....2.163, 2.167, 3.156, 3.158  
 gating (CDMA).....2.146, 3.108  
 ramping (DECT).....2.327, 3.56  
 ramping (digital modulation).....2.112, 3.76  
 ramping (GSM/EDGE).....2.309, 3.99  
 ramping (NADC).....2.270, 3.118  
 ramping (PDC).....2.287, 3.128  
 ramping (PHS).....2.124, 3.137  
 ratio (fading simulation).....3.87  
 supply.....1.1  
 total (W-CDMA).....3.156  
 Power control.....2.176  
 Power offset (additional MS).....2.261  
 PPE (Parallel poll enable register).....3.222  
 PRACH (3GPP W-CDMA).....2.202  
 PRBS  
 Polynomial.....2.375  
 PRBS data (digital modulation).....2.94, 3.69  
 Preamble (DECT)  
 normal.....2.331  
 prolonged.....2.332  
 Preamble (PHS).....2.128  
 Preamble data field (PDC).....2.292, 2.297, 2.299  
 Preamble Repetition.....2.202, 2.203  
 Preemphasis (FM).....2.61, 2.62, 3.79  
 Preset (instrument states).....1.3, 3.205  
 Profile (fading simulation).....2.75, 2.80, 2.84, 3.87, 3.89, 3.92  
 Programming Examples.....D.1  
 Protection level.....3.205  
 Protective circuit.....2.54, 3.47  
 PS-ID-Code-Data field (PHS).....2.129  
 PSK modulation.....2.87  
**PTRansition register.....3.219**  
 Pulling range.....2.414  
 PULS input.....2.21  
 Pulse modulation.....2.65, 3.147  
 polarity.....2.65, 3.147  
 test assembly.....5.4  
 test procedure.....5.33  
 Pure doppler profile (fading simulation).....3.87  
 Putting into operation.....1.1
- Q**
- Q FADED output.....2.13  
 Q output.....2.9

- QAM modulation ..... 2.87
- Quadrature error**
- vector modulation** ..... 5.29
- Quadrature offset ..... 2.67, 3.66
- Queries** ..... 3.5
- responses ..... 3.8
- Question ..... 3.11
- Quick selection**
- menu ..... 2.25
- parameter** ..... 2.25
- Quotation marks ..... 3.11
- R**
- Rack 19" ..... 1.16
- RAM, test ..... 4.2
- Ramp data field
- NADC ..... 2.274
- PDC ..... 2.292
- PHS ..... 2.128
- RAMP data field
- DECT ..... 2.331
- Rated characteristics
- checking ..... 5.1
- test procedures ..... 5.8
- Rayleigh fading ..... 2.75, 2.80, 3.87, 3.89
- RCL list (MSEQ) ..... 2.406, 3.204
- RECALCULATE ..... 2.386, 3.64
- Recall
- frame (DECT) ..... 2.329, 3.58
- frame (GSM/EDGE) ..... 2.311, 3.100
- frame (NADC) ..... 2.272, 3.120
- frame (PDC) ..... 2.289, 3.129
- frame (PHS) ..... 2.125, 3.138
- instrument settings ..... 2.43, 3.16
- mapping (CDMA) ..... 2.144, 3.107
- REF input/output ..... 2.19, 2.414, 3.148
- Reference
- external ..... 2.414, 3.148
- internal ..... 2.414, 3.148
- oscillator (calibration) ..... 2.417, 3.38
- oscillator OCOXO ..... 1.5, 2.414, 3.148
- Reference frequency
- test procedure ..... 5.12
- Remote control ..... 3.1
- REMOTE state ..... 3.2
- Remove paneling** ..... 1.4
- RES input ..... 2.375
- Reset status reporting system ..... 3.227
- Responses to queries ..... 3.8
- Reverse link signal (CDMA) ..... 2.146, 2.148, 3.103
- RF
- frequency ..... 2.45, 3.80
- output ..... 2.9, 3.47
- output level ..... 2.47, 3.145
- sweep ..... 2.396, 3.149
- RF OFF ..... 2.54
- Ricean fading ..... 2.75, 3.87
- Roll-off factor
- 3GPP W-CDMA ..... 2.183, 3.165
- CDMA ..... 2.139, 3.104
- digital modulation ..... 2.107, 3.75
- NADC ..... 2.267, 3.117
- PDC ..... 2.284, 3.126
- PHS ..... 2.120, 3.136
- W-CDMA ..... 2.157, 3.154
- Rotary knob ..... 2.7, 2.23
- RS232 interface ..... 2.19, 2.411, 3.202, A.4
- S**
- Same data (3GPP W-CDMA) ..... 2.226
- Sample setting ..... 2.27
- Sample-and-hold mode ..... 2.50
- Save
- frame (DECT) ..... 2.329, 3.58
- frame (GSM/EDGE) ..... 2.311, 3.100
- frame (NADC) ..... 2.272, 3.120
- frame (PDC) ..... 2.289, 3.129
- frame (PHS) ..... 2.125, 3.138
- instrument settings ..... 2.43, 3.16
- mapping (CDMA) ..... 2.145, 3.107
- SCPI
- conformity information ..... C.1
- introduction ..... 3.5
- Scrambling
- PDC ..... 2.291, 2.299, 3.130
- PHS ..... 2.127, 3.139
- Scrambling code ..... 2.232
- Scrambling code generator** ..... 2.171
- Scrambling Unit** ..... 2.174
- Scrollbar ..... 2.23
- Select
- 1-out-of-n** ..... 2.24
- mark ..... 2.23
- Self test ..... 3.16, 3.207, 4.1
- Semicolon ..... 3.11
- Sequence length (3GPP W-CDMA) ..... 2.182, 3.165
- SER DATA input ..... 2.412
- SERDATA-Interface ..... A.7
- Serial modulation data (digital modulation) ..... 2.96
- Serial number ..... 2.427, 3.15
- Serial poll ..... 3.225
- Service request (SRQ) ..... 3.16, 3.225
- Service request enable register (SRE) ..... 3.16, 3.221
- Setting commands** ..... 3.5
- Setting conflicts (digital modulation) ..... 2.91
- Setting time
- Test assembly ..... 5.6
- Setting value** ..... 2.24
- Settling bit** ..... 3.223
- SFN ..... 2.242
- SFN restart ..... 2.242
- SFN Restart Trigger ..... 2.215
- Short form (commands) ..... 3.7
- Sign ..... 3.9
- Signal (data generator)
- BGATE (burst gate) ..... 2.93
- CW (continuous wave) ..... 2.93
- HOP (hopping) ..... 2.93
- LATT (level attenuation) ..... 2.93
- TRIG1/2 (trigger output1/2) ..... 2.93
- Signal delay
- Fading simulation .. 2.76, 2.80, 2.82, 2.84, 3.88, 3.90, 3.92
- Signal generation
- downlink (W-CDMA) ..... 2.150
- downlink and uplink without IQ multiplex (W-CDMA) 2.154
- uplink with IQ multiplex (W-CDMA) ..... 2.151, 2.165
- Signature (3GPP W-CDMA) ..... 2.175, 2.202, 2.204
- Simulation of scenarios ..... 2.234
- Simultaneous modulation ..... 2.57
- Slot
- Configuration
- GSM/EDGE ..... 2.316
- Slot (DECT) ..... 2.330
- Slot and frame builder** ..... 2.175
- SMIQ03S
- Additional measurements ..... 5.80
- Software option ..... 2.431
- Software version ..... 2.427, 3.42
- SOURce

- Modulation subsystem..... 3.114
  - Source resistance..... 2.54
  - Span (RF sweep)..... 2.396, 3.81
  - Special characters**..... **3.13**
  - Spectral purity..... 2.62, 2.64
    - test procedure..... 5.18
  - Spectrum of a W-CDMA signal..... 2.225
  - Spreading scheme..... 2.220
  - Spurious-Free Dynamic Range
    - test procedure..... 5.78
  - Square brackets..... 3.7
  - SRE (service request enable register)..... 3.16, 3.221
  - SRQ (service request)..... 3.16, **3.225**
  - Standard Fading..... 2.73
  - STANDBY mode..... 1.1, 1.2, 2.11
  - Start bit (RS232)**..... **A.5**
  - Start frequency
    - LF sweep..... 2.400, 3.195
    - RF sweep..... 2.396, 3.81
  - Start level (level sweep)..... 2.398, 3.146
  - State REMOTE..... 3.2
  - STATus
    - OPERation register..... 3.199, 3.223
    - QUEStionable register..... 3.200, **3.224**
  - Status byte (STB)..... 3.221
  - Status line**..... **2.22**
  - STATUS page..... 2.432
  - Status register (overview)..... 3.220
  - Status reporting system..... 3.218
  - STB (status byte)..... 3.221
  - Steal Flag data field (PDC)..... 2.293, 2.300
  - Step width
    - frequency..... 2.45, 3.81
    - level..... 2.48, 3.146
    - level sweep..... 2.398, 3.151
    - LF sweep..... 2.400, 3.198
    - RF sweep..... 2.397, 3.150
    - rotary knob
      - frequency variation..... 2.45, 3.81
      - level..... 3.146
      - level variation..... 2.48
  - Stop bit (RS232)..... 2.411, 3.202, **A.5**
  - Stop frequency
    - LF sweep..... 2.400, 3.195
    - RF sweep..... 2.396, 3.81
  - Stop level (level sweep)..... 3.146
  - Storage..... 4.1
  - Store
    - frame (DECT)..... 2.329, 3.58
    - frame (GSM/EDGE)..... 2.311, 3.100
    - frame (NADC)..... 2.272, 3.120
    - frame (PDC)..... 2.289, 3.129
    - frame (PHS)..... 2.125, 3.138
    - instrument settings..... 2.43, 3.16
    - list..... 2.35
    - mapping (CDMA)..... 2.145, 3.107
  - Structure
    - command..... 3.6
    - command line..... 3.8
  - Sum bit**..... **3.219**
  - Sum deviation..... 2.57
  - Sum modulation depth..... 2.57
    - two-tone modulation..... 2.57
  - Summation..... 2.177
  - Summing loop..... 2.418
    - slot..... 1.5
  - Sweep..... 2.392
    - level..... 2.398, 3.146, 3.151
    - level sweep..... 2.398
    - LF..... 2.399, 3.197
    - outputs..... 2.394
    - RF..... 2.396, 3.81, 3.149
    - test procedure..... 5.24
    - trigger..... 2.394, 3.210
  - Switchover to remote control..... 3.2
  - SYMBOL CLOCK input/output..... 2.13, 2.97
  - Symbol..... 2.25
  - Symbol clock
    - CDMA..... 2.142
    - digital modulation..... 2.111, 3.76
    - NADC..... 2.270, 3.118
    - PDC..... 2.287, 3.127
    - PHS..... 2.123, 3.137
  - SYMBOL CLOCK input/output..... 2.7, 2.95
  - Symbol rate
    - 3GPP W-CDMA..... 2.189, 2.197, 2.208, 3.170
    - DECT..... 2.323, 3.55
    - digital modulation..... 2.106, 3.75
    - enhanced channels..... 2.248, 2.256, 3.184
    - GSM/EDGE..... 2.305, 3.97
    - NADC..... 2.267, 3.116
    - OCNS..... 2.257, 3.188
    - PDC..... 2.284, 3.126
    - PHS..... 2.120, 3.135
  - SYNC burst (DECT)..... 2.330
  - SYNC burst (PHS)..... 2.127
  - Synchronization
    - CDMA..... 2.133
    - command..... 3.217
    - DECT..... 2.319
    - PHS..... 2.116
    - signal generation (digital modulation)..... 2.93
    - W-CDMA..... 2.152
  - Synchronization signal
    - 3GPP W-CDMA..... 2.215
  - Synthesis range..... 2.62, 2.64
  - System bandwidth..... 2.384
  - System components (3GPP W-CDMA)..... 2.171
  - System frame number..... 2.236, 2.238, 2.242
  - System Frame Number..... 2.241
  - System information BCH..... 2.242
- ## T
- Tags (ARB)..... 3.23
  - Tail data field (GSM/EDGE)..... 2.312, 2.316
  - TCH, Traffic Channel configuration
    - NADC..... 2.274, 3.121
    - PDC..... 2.291, 3.130
    - PHS..... 2.127, 3.139
  - Termination criteria
    - BLER..... 2.381
  - Test..... 2.427
  - Test assembly..... 5.2
    - analog modulations..... 5.2
    - broadband FM..... 5.3
    - fading simulation..... 5.6
    - output impedance..... 5.5
    - pulse modulation..... 5.4
    - Setting time..... 5.6
    - SSB phase noise..... 5.5
    - vector modulation..... 5.4
  - Test equipment..... 5.1
  - Test frequency (recommended)..... 5.7
  - Test level (recommended)..... 5.7
  - Test model (3GPP W-CDMA)..... 2.180
  - Test points..... 2.425, 3.42
  - Test procedure
    - 3GPP W-CDMA..... 5.53
    - amplitude modulation..... 5.31
    - Arbitrary Waveform Generator..... 5.77
    - Bit error rate test..... 5.63

- broadband AM ..... 5.33
  - data generator ..... 5.41
  - DC voltage offset ..... 5.78
  - DECT ..... 5.47
  - digital modulation ..... 5.38
  - digital standards ..... 5.45
  - Enhanced Channels ..... 5.62
  - error vector ..... 5.27
  - fading simulation ..... 5.64
  - frequency ..... 5.8
  - frequency modulation ..... 5.34
  - GSM/EDGE ..... 5.46
  - I/Q imbalance ..... 5.29
  - IS-95 CDMA ..... 5.51
  - level ..... 5.12
  - Measurements for SMIQ03S ..... 5.80
  - memory extension SMIQB12 ..... 5.41
  - modulation generator ..... 5.25
  - NADC ..... 5.48
  - noise generation and distortion simulation ..... 5.70
  - PDC ..... 5.49
  - phase modulation ..... 5.37
  - PHS ..... 5.50
  - pulse modulation ..... 5.33
  - reference frequency ..... 5.12
  - spectral purity ..... 5.18
  - spurious-free dynamic range ..... 5.78
  - sweep ..... 5.24
  - TETRA ..... 5.48
  - vector modulation ..... 5.26
  - W-CDMA ..... 5.52
  - Test procedures ..... 5.8
  - TETRA - Digital standard
    - test procedure ..... 5.48
  - TFCI (3GPP W-CDMA) ..... 2.175, 2.194, 2.205, 3.169
  - Time domain (3GPP W-CDMA) ..... 2.219
  - Time grid
    - Fading simulation ..... 2.84
  - Timing offset (3GPP W-CDMA) 2.176, 2.198, 2.205, 2.209, 2.229, 3.173
  - Timing offset (Enhanced Channels) ..... 2.249
  - Total power
    - 3GPP W-CDMA ..... 2.187, 3.168
    - CDMA ..... 2.143, 3.106
  - TPC (3GPP W-CDMA) ..... 2.175, 2.198, 2.200, 3.173
  - TPC bit (3GPP W-CDMA) ..... 2.195, 2.206, 3.169
  - Training sequence code (GSM/EDGE) ..... 2.312, 2.317
  - Transfer clock ..... 2.373
  - Trigger
    - 3GPP W-CDMA ..... 2.184, 2.336, 3.167
    - active edge ..... 2.114, 2.429, 3.77, 3.214
    - ARB ..... 2.347, 3.20
    - CDMA ..... 2.140, 3.105
    - DECT ..... 2.319, 2.323, 3.55
    - delay
      - 3GPP W-CDMA ..... 2.336
    - digital modulation ..... 2.109, 3.69, 3.77
    - GPS ..... 3.94
    - GSM/EDGE ..... 2.306, 3.98
    - inhibition
      - 3GPP W-CDMA ..... 2.337
      - ARB ..... 2.347, 3.20
    - inhibition (3GPP W-CDMA) ..... 2.185, 3.167
    - inhibition (CDMA) ..... 2.141, 3.105
    - inhibition (DECT) ..... 2.325, 3.56
    - inhibition (digital modulation) ..... 2.110, 3.77
    - inhibition (GSM/EDGE) ..... 2.307, 3.98
    - inhibition (NADC) ..... 2.269, 3.117
    - inhibition (PDC) ..... 2.286, 3.127
    - inhibition (PHS) ..... 2.122, 3.136
    - inhibition (W-CDMA) ..... 2.159
    - LIST ..... 2.402, 3.212
    - MSEQ ..... 3.214
    - NADC ..... 2.267, 3.117
    - OFF TIME (ARB) ..... 2.348, 3.21
    - ON TIME (ARB) ..... 2.348, 3.21
    - oscilloscope ..... 2.394, 3.112
    - PDC ..... 2.284, 3.126
    - PHS ..... 2.116, 2.120, 3.136
    - Sequence control (ARB) ..... 2.345, 3.19
    - source
      - 3GPP W-CDMA ..... 2.185, 2.336, 3.167
      - ARB ..... 2.347, 3.20
      - sweep ..... 2.394, 3.210
      - W-CDMA ..... 2.158, 3.155
      - XY recorder ..... 2.394, 3.149
  - TRIGGER
    - input ..... 2.21, 2.402, 2.407, 2.429
  - Trigger generator (ARB) ..... 2.344
  - Trigger Out GSM ..... 2.308
  - Trigger signal
    - 3GPP W-CDMA ..... 2.215
  - Triggering action** ..... **2.25**
  - TRIGIN input ..... 2.15
  - TRIGOUT output ..... 2.15
  - Truth values ..... 3.8
  - Tuning voltage ..... 2.415
  - Two-channel fading ..... 2.71
  - Two-tone modulation ..... 2.57
- ## U
- UCOR (level correction) ..... 2.52, 3.51
  - Uncorrelated data (3GPP W-CDMA) ..... 2.226
  - Unique word (PHS) ..... 2.128
  - Unit ..... 2.5, 3.8, 3.215
  - Universal commands ..... A.3
  - Uplink
    - DECT ..... 2.318
    - GSM/EDGE ..... 2.301
    - NADC ..... 2.262
    - PDC ..... 2.279
    - PHS ..... 2.115
  - Uplink signal
    - 3 GPPW-CDMA ..... 2.182, 3.165
  - User correction (UCOR) ..... 2.52, 3.51
- ## V
- Variation period
    - Fading simulation ..... 2.82, 3.91
  - VCO SUM calibration ..... 2.418, 3.39
  - Vector modulation ..... 2.66, 2.67, 2.356, 3.65
    - calibration ..... 2.419, 3.39
    - IQ filter ..... 2.68
    - Quadrature error** ..... **5.29**
    - test assembly ..... 5.4
    - test procedure ..... 5.26
  - Ventilation ducts** ..... **1.4**
  - Voltage
    - external modulation signal ..... 2.56
    - LF output ..... 2.391, 3.48
  - VOX
    - PDC ..... 2.298, 3.130
    - PHS ..... 2.127, 3.139

**W**

Walsh code (CDMA).....	2.145, 3.107
Waveform memory (3GPP W-CDMA).....	2.183
W-CDMA .....	2.150
Multicode.....	3.156
test procedure .....	5.52
Trigger.....	2.158
W-CDMA 3GPP.....	2.169, 3.159
Additional .....	3.180
Enhanced Channels .....	3.180
OCNS.....	3.180
test procedure .....	5.53
White space.....	3.11
WinIQSIM	
Support of ARB .....	2.344

**X**

X field (DECT).....	2.333
X_AXIS output .....	2.21, 2.394
XY recorder.....	2.394, 3.149

**Z**

Z field (DECT).....	2.333, 3.60
---------------------	-------------